

CURRENT PRICE as
of January 05, 2026

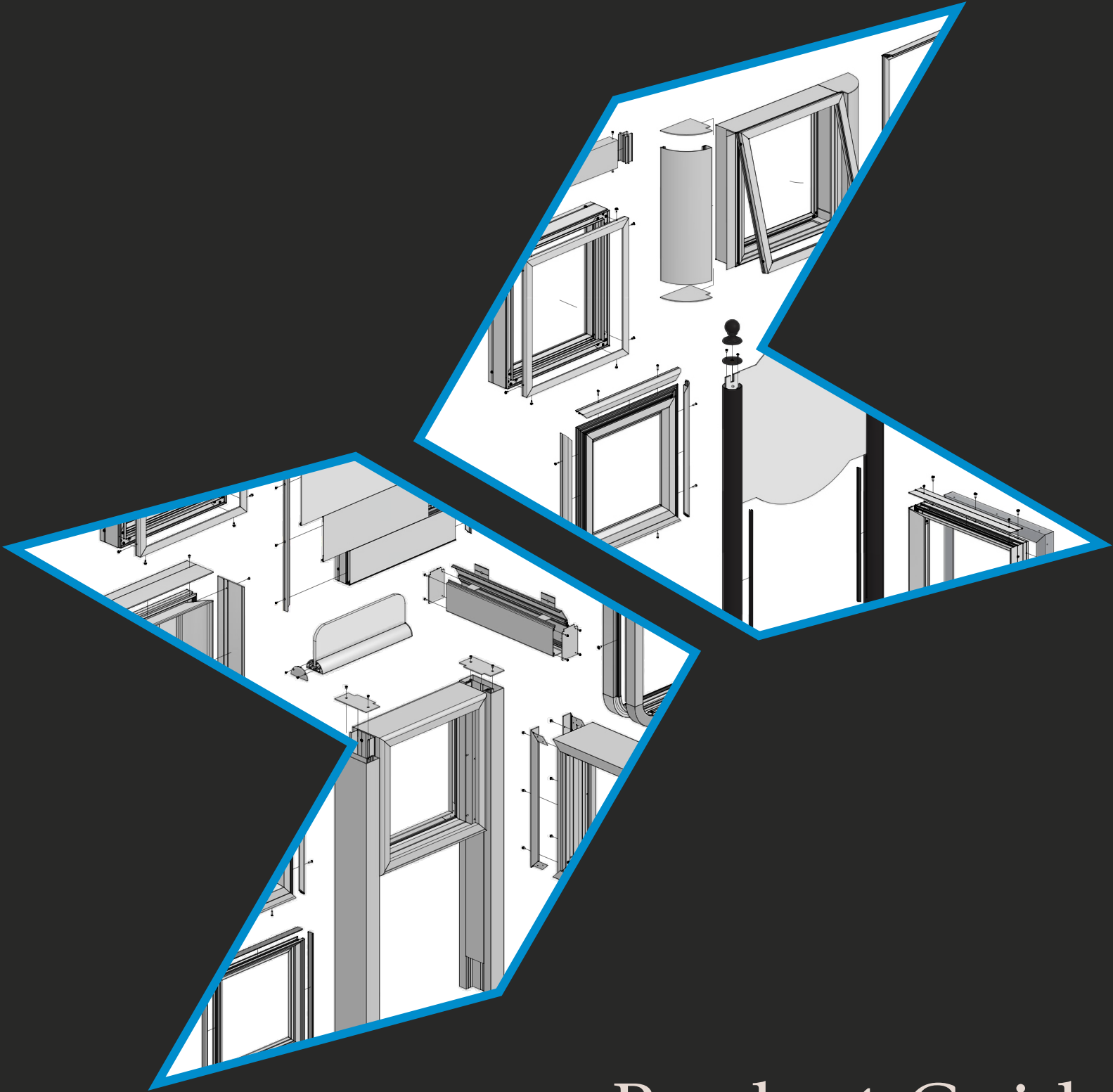

Sign Extrusions and Systems



Product Guide

Volume 3.3

Index - Extrusion Solutions for the Sign Industry

COMMERCIAL

Extrusions by the Length			pages 4-10
Sign Cabinet Bodies	4	Retro Tension Frames and Covers	8
Hingeable Retainers and Covers	5-6	Retro Fascia Frames and Cover	9
Dividers / Hingeable Vandal Systems	6	Wall Mount Tension Frames and Covers	9
Radius Ends	7	Compression Reinforcement	10
Tension Bodies and Covers	7	Soft Signage Frames and Covers	10
System Accessories			pages 11-14
Radius Corners	11	Components / Hardware	12-14
System Configurations			pages 15-23
System Specifications			pages 24-36
Sign Cabinet Bodies	24-25	Tension Bodies and Covers	32
Hingeable Retainers and Covers	26-27	Retro / Tension Frames and Covers	33-34
Dividers	28	Retro Fascia Frames and Cover	34
Hingeable Vandal Systems	29	Wall Mount Tension Frames, Covers and Tools	35
Hingeable Retainer for Insert Panels	30	Soft Signage Frames and Covers	36
Radius Ends	31		
Flexible Face Preparation / Extrusion Guidelines			page 37
Frame Brace and Frame Support Tube Placement			page 38

ARCHITECTURAL

Extrusions by the Length			pages 40-45
Series 1 Posts / Copy Bars and Reveal	40	Sign Cabinet Bodies / Retainers and Covers / Divider	43
Panel Adaptors / Reveal and Fillers	40	Insert Panel Systems	44
Post and Panel Systems - Series 2, 3, 4 & 7	40-42	Monolithic Edges / Radius Ends	45
System Accessories			pages 46-48
System Configurations			pages 49-55
System Specifications			pages 56-66
Series 1 Post and Panel / Copy Bar Systems	56-57	Hingeable Sign Cabinet Bodies / Retainers / Dividers	62-64
Post and Panel Systems - Series 2, 3, 4 & 7	57-60	Monolithic Edges	64
Panel Adaptor Systems	59	Insert Panel Systems	65
Non-Hingeable / Hingeable Post and Panel Systems	61-62	Radius Ends	66
Architectural System Combinations			page 67
RTS Post & Panel System			page 68

STANDARD

Extrusions by the Length			pages 70-76
Sign Cabinet Bodies / Retainers	70	Wall Frames	72
Dividers / Vandal Systems / Menu Board System	71	Standard Moldings	72
Edge Lit	71	Socket and Ballast Raceways	72
Snap Frames and Covers	72	Channel Letter Raceways / Splicing Guidelines	73-76
System Accessories			pages 76-78
System Configurations			pages 79-83
System Specifications			pages 84-90
Sign Cabinet Bodies / Retainers	84-85	Edge Lit Systems / Snap Frame Systems	89
Dividers	86	Wall Frames / Moldings / Raceways	90
Vandal Systems	86-87	Channel Letter Raceway Systems	91-92
Menu Board System	88		











ECONOCOMP

Extrusions by the Length			page 94
Sign Cabinet Fillers / Moldings / Divider	94		
System Accessories			page 94
System Configurations			page 95
System Specifications			pages 96-97
Sign Cabinet Fillers	96	Moldings / Divider	97
Cutting Services			page 98
Additional Information			page 99

Commercial Products

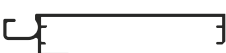

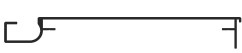









Extrusions Priced by the Length

Part	Part Number	Length	Mill Finish	Dk. Bronze	
Sign Cabinet Bodies					
With Reveal					
	Wide Body	2005 2005P	24'-6"	\$697.70 <i>Cost per Foot</i> 28.48	\$946.95 38.75
	Medium Body	2015 2015P	24'-6"	454.38 <i>Cost per Foot</i> 18.55	624.14 25.48
	Single Face Body	2025 2025P	24'-6"	306.35 <i>Cost per Foot</i> 12.50	424.60 17.33
	Narrow Single Face Body	2021 2021P	24'-6"	254.63 <i>Cost per Foot</i> 10.39	352.91 14.40
	Slimline Single Face Body	2020 2020P	24'-6"	155.01 <i>Cost per Foot</i> 6.33	214.81 8.77
	Retro Body	2040	24'-6"	109.85 <i>Cost per Foot</i> 4.48	N/A
Without Reveal					
	Flat 2 Piece Double Face Body	2009	24'-6"	382.74 <i>Cost per Foot</i> 15.62	N/A
	Flat 2 Piece Double Face Medium Body	2010	24'-6"	326.41 <i>Cost per Foot</i> 13.32	N/A
	Flat Double Face Body	2008	24'-6"	506.54 <i>Cost per Foot</i> 20.68	N/A
	Flat Double Face Medium Body	2007	24'-6"	362.08 <i>Cost per Foot</i> 14.78	N/A
	Flat Single Face Body	2027	24'-6"	260.11 <i>Cost per Foot</i> 10.62	N/A
	Flat Wall Mount Retro Body	2042	24'-6"	151.00 <i>Cost per Foot</i> 6.16	N/A
	Flat Retro Body	2041	24'-6"	147.82 <i>Cost per Foot</i> 6.03	N/A





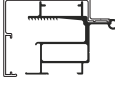
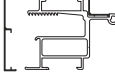





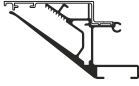
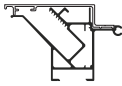
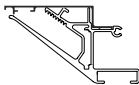
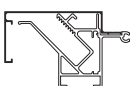

Note: All dimensions are subject to the tolerance standards of the aluminum extrusion industry. Profile drawings are illustrative and rounded to the nearest 1/16".

Extrusions Priced by the Length

Part	Part Number	Length	Mill Finish	Dk. Bronze
Hingeable Retainers and Covers				
For Rigid Plastic or Flush Aluminum Faces				
With Reveal				
	1-1/2" Retainer	24'-6"	\$121.67 <i>Cost per Foot</i> 4.97	\$163.45 6.67
	1-1/2" Retainer II	24'-6"	165.46 <i>Cost per Foot</i> 6.75	223.42 9.12
	1-1/2" Frame	24'-6"	108.23 <i>Cost per Foot</i> 4.42	N/A
	1-1/2" Frame Cover	24'-6"	84.60 <i>Cost per Foot</i> 3.45	115.38 4.71
	2-1/4" Retainer	24'-6"	218.57 <i>Cost per Foot</i> 8.92	297.27 12.13
Without Reveal				
	Flat 1-1/2" Retainer	24'-6"	168.23 <i>Cost per Foot</i> 6.87	N/A
	Flat 2" Retainer	24'-6"	191.55 <i>Cost per Foot</i> 7.82	N/A
Note: Part #2052 and #2047 are engineered to integrate with the Flat Bodies.				
For Bleed Pan Form Faces				
	Bleed Rigid Retainer	24'-6"	155.11 <i>Cost per Foot</i> 6.33	N/A
	Flat Bleed Rigid Retainer	24'-6"	158.11 <i>Cost per Foot</i> 6.45	N/A
Note: Part #2204 is engineered to integrate with the Flat Bodies.				
For Insert Panels				
	Commercial Access Frame	24'-6"	222.32 <i>Cost per Foot</i> 9.07	N/A
Note: Part #2060 is engineered to integrate with Architectural System covers. See pages 43 and 44 for optional covers.				
For Rigid Plastic or Flexible Faces				
	Dual Frame	24'-6"	215.33 <i>Cost per Foot</i> 8.79	N/A
	2-1/4" Dual Frame Cover	24'-6"	105.55 <i>Cost per Foot</i> 4.31	143.89 5.87

Extrusions available in full lengths and cut to size kits.

Extrusions Priced by the Length

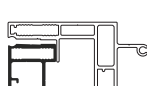



	Part	Part Number	Length	Mill Finish	Dk. Bronze	
For Flexible Faces		Tension Frame II	2086	24'-6"	\$288.36 <i>Cost per Foot</i> 11.77	N/A
		Tension Frame	2085	24'-6"	222.36 <i>Cost per Foot</i> 9.08	N/A
		Bleed Tension Frame Cover (For use with Part #2086 and #2085)	2095 2095P	24'-6"	66.73 <i>Cost per Foot</i> 2.72	90.62 3.70
		1-1/2" Tension Frame Cover (For use with Part #2086 and #2085)	2084 2084P	24'-6"	98.52 <i>Cost per Foot</i> 4.02	133.85 5.46
Dividers For Rigid Plastic Faces		1-1/2" Divider (For use with Part #2053)	2133 2133P	24'-0"	115.12 <i>Cost per Foot</i> 4.80	156.87 6.54
		2" Divider	2138 2138P	24'-0"	165.59 <i>Cost per Foot</i> 6.90	225.66 9.40
		Flat 2" Divider	2130	22'-3"	199.79 <i>Cost per Foot</i> 8.98	N/A
		2-3/4" Divider	2128 2128P	24'-0"	244.17 <i>Cost per Foot</i> 10.17	336.50 14.02
		1-1/4" Divider	1662	24'-0"	92.98 <i>Cost per Foot</i> 3.87	N/A
		Insert Divider	1668	16'-0"	77.17 <i>Cost per Foot</i> 4.82	N/A
	For Rigid Plastic and/or Flexible Faces		Dual Divider	2142	24'-0"	306.94 <i>Cost per Foot</i> 12.79
		2-1/2" Dual Divider Cover	2146 2146P	24'-0"	58.02 <i>Cost per Foot</i> 2.42	78.29 3.26
Hingeable Vandal Systems		Inner Frame Retainer	2099 2099P	24'-6"	188.46 <i>Cost per Foot</i> 7.69	268.83 10.97
		2Part Outer Frame	1942 1942P	24'-6"	103.39 <i>Cost per Foot</i> 4.22	135.15 5.52
		Large Inner Frame Retainer	2097 2097P	24'-6"	319.79 <i>Cost per Foot</i> 13.05	456.58 18.64
		2Part Large Outer Frame	1941 1941P	24'-6"	233.53 <i>Cost per Foot</i> 9.53	305.25 12.46

Extrusions available in full lengths and cut to size kits.

US Patent Numbers 6,061,941 / 6,637,080
CA Patent Numbers 2,245,623 / 2,387,222

Note: All dimensions are subject to the tolerance standards of the aluminum extrusion industry. Profile drawings are illustrative and rounded to the nearest 1/16".

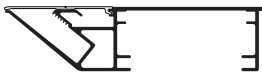
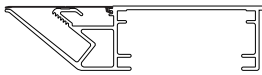
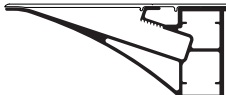
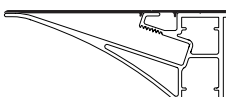
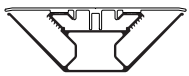





Extrusions Priced by the Length

Part	Part Number	Length	Mill Finish	Dk. Bronze	
Radius Ends					
	6" Radius 1/4 Round End	1671	24'-6"	\$381.17 <i>Cost per Foot</i> 15.56	N/A
	6" Radius 1/4 Round Pole Cover	1672	24'-6"	399.48 <i>Cost per Foot</i> 16.31	N/A
	8-1/2" Radius 3 Part End	1673	24'-6"	399.48 <i>Cost per Foot</i> 16.31	N/A
<p>Note: Part #1671 and #1672 require two (2) 1/4 Rounds to make one half round. Part #1673 requires three (3) 3 Part Ends to make one half round.</p>					
Tension Bodies and Covers					
For Flexible Faces					
	7" Single Face Tension Body	2224	24'-6"	517.33 <i>Cost per Foot</i> 21.12	N/A
	Flat Bleed Retro Frame Cover	2121-12'3"	12'-3"	29.60 <i>Cost per Foot</i> 2.42	N/A
	6" Flat Bleed Single Face Tension Body	2233	24'-6"	561.60 <i>Cost per Foot</i> 22.92	N/A
	6" Flat Bleed Single Face Tension Cover	2238	24'-6"	138.59 <i>Cost per Foot</i> 5.66	N/A
	5" Flat Bleed Double Face Tension Body	2230	24'-6"	266.28 <i>Cost per Foot</i> 10.87	N/A
	5" Flat Bleed Double Face Tension Cover	2235	24'-6"	137.34 <i>Cost per Foot</i> 5.61	N/A

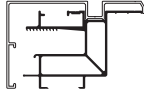
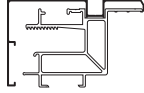
Extrusions available in full lengths and cut to size kits.
Part #1672 and #1673 available in full lengths only.

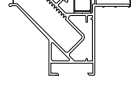
US Patent Numbers 6,061,941 / 6,637,080
CA Patent Numbers 2,245,623 / 2,387,222



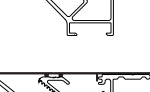
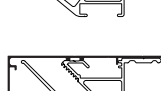
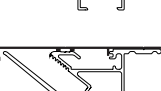
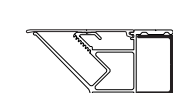
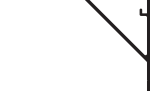



Extrusions Priced by the Length

Part	Part Number	Length	Mill Finish	Dk. Bronze	
Retro Tension Frames and Covers					
For Flexible Faces					
	2" Retro Frame	2112	24'-6"	\$246.36 <i>Cost per Foot</i> 10.06	N/A
	2-3/8" Retro Frame Cover (For use with Part #2112 and #2105)	2115 2115P	24'-6"	117.89 <i>Cost per Foot</i> 4.81	161.08 6.57
	Bleed Retro Frame	2105	24'-6"	213.75 <i>Cost per Foot</i> 8.72	N/A
	Bleed Retro Frame Cover	2122 2122P	24'-6"	76.99 <i>Cost per Foot</i> 3.14	103.06 4.21
	Flat Bleed Retro Frame w/ Reflector Slot	2103	24'-6"	221.51 <i>Cost per Foot</i> 9.04	N/A
	Flat Bleed Retro Frame	2104	24'-6"	222.36 <i>Cost per Foot</i> 9.08	N/A
	Flat Bleed Retro Frame II	2107	24'-6"	262.00 <i>Cost per Foot</i> 10.69	N/A
	Flat Bleed Retro Frame Cover (For use with Part #2103, #2104 and #2107)	2121-12'3"	12'-3"	29.60 <i>Cost per Foot</i> 2.42	N/A
	Extended Flat Bleed Retro Frame Cover (For use with Part #2103 and #2104)	2123	24'-6"	78.08 <i>Cost per Foot</i> 3.19	N/A
	Extended Flat Bleed Retro Frame Cover II (For use with Part #2107)	2124	24'-6"	80.35 <i>Cost per Foot</i> 3.28	N/A
	1-1/2" Flat Bleed Retro Frame Cover (For use with Part #2103 and #2104)	2125	24'-6"	120.09 <i>Cost per Foot</i> 4.90	N/A
	1-1/2" Flat Bleed Retro Frame Cover II (For use with Part #2107)	2127	24'-6"	127.49 <i>Cost per Foot</i> 5.20	N/A
	Wall Mount Frame (For use with Part #2104)	2100	24'-6"	283.94 <i>Cost per Foot</i> 11.59	N/A

Note: Part #2104 and #2107 are engineered to integrate with the Flat Bodies.

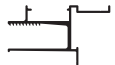
Note: All dimensions are subject to the tolerance standards of the aluminum extrusion industry. Profile drawings are illustrative and rounded to the nearest 1/16".



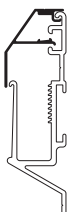
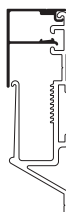
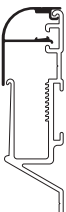



Extrusions Priced by the Length

Part	Part Number	Length	Mill Finish	Dk. Bronze	
Retro Fascia Frames and Cover					
For Flexible Faces					
	Bleed Fascia Frame	2092	24'-6"	\$187.89 <i>Cost per Foot</i> 7.67	N/A
	Bleed Fascia Frame Cover	2093	22'-3"	89.54 <i>Cost per Foot</i> 4.02	N/A
	1-1/2" Fascia Frame	2094	24'-6"	156.67 <i>Cost per Foot</i> 6.39	N/A
Wall Mount Tension Frames and Covers					
For Flexible Faces					
	Front Load Wall Mount Tension Frame	2080	24'-6"	318.59 <i>Cost per Foot</i> 13.00	N/A
	Front Load Wall Mount Tension Frame Cover	2078	24'-6"	64.34 <i>Cost per Foot</i> 2.63	N/A
	Wall Mount Tension Frame	2090	24'-6"	229.34 <i>Cost per Foot</i> 9.36	N/A
	Wall Mount Tension Frame Beveled Cover	2091	24'-6"	78.08 <i>Cost per Foot</i> 3.19	N/A
	Wall Mount Tension Frame Square Cover	2088	24'-6"	85.56 <i>Cost per Foot</i> 3.49	N/A
	Wall Mount Tension Frame Radius Cover	2089	24'-6"	85.56 <i>Cost per Foot</i> 3.49	N/A

Extrusions available in full lengths only.
Wall Mount Tension Frame and Covers available in full lengths and kits.

US Patent Numbers 6,061,941 / 6,637,080
CA Patent Numbers 2,245,623 / 2,387,222

Extrusions Priced by the Length



















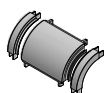
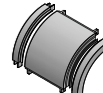
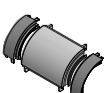
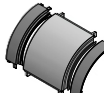

Part	Part Number	Length	Mill Finish	Clear Anodized	
Compression Reinforcement					
	Front Load Wall Mount Tension Frame Support (For use with Part #2080)	2171	20'-0"	197.37 <i>Cost per Foot</i> 9.87	N/A
	Frame Support Tube 3/4" x 1-5/8"	2175	24'-0"	137.62 <i>Cost per Foot</i> 5.73	N/A
	Small Frame Support Tube 1" x 1"	2177	24'-0"	111.65 <i>Cost per Foot</i> 4.65	N/A
Soft Signage Frames and Covers For Fabric Faces					
	1" Front Load Soft Signage Frame	3092 3092A	20'-0"	102.25 <i>Cost per Foot</i> 5.11	136.07 6.80
	3-1/2" Front Load Soft Signage Frame	3095 3095A	20'-0"	177.16 <i>Cost per Foot</i> 8.86	224.64 11.23
	Soft Signage Support	3085	20'-0"	57.49 <i>Cost per Foot</i> 2.87	N/A
	Front Load Grip Strip (Polypropylene and TPV) (Four (4) lengths needed per 20' single face frame)	3098	10'-0"	*17.11 <i>Cost per Foot</i> 1.71	N/A
	Z-Clip	3099	12'-0"	23.25 <i>Cost per Foot</i> 1.94	N/A

Extrusions available in full lengths and cut to size kits.

*Black finish
US Patent Numbers 8,595,966
CA Patent Numbers 2,754,507





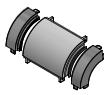
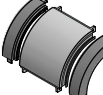
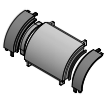
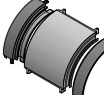





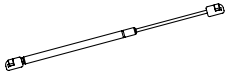

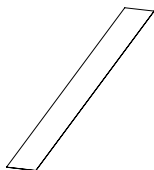

Note: All dimensions are subject to the tolerance standards of the aluminum extrusion industry. Profile drawings are illustrative and rounded to the nearest 1/16".

Commercial System Accessories

6"	9"	Part	Part Number	Price / box of four (4) assemblies	6"	9"	Part	Part Number	Price / box of four (4) assemblies
Radius Corners For Rigid Plastic Faces 1-1/2" Retainer					For Flexible Faces Tension Frame w/ Bleed Tension Frame Cover				
		Narrow S/F Body	6" 4465	\$584.09			Narrow S/F Body	6" 4485	\$614.65
		Single Face Body	6" 4565 9" 4560	584.09 639.80			Single Face Body	6" 4585 9" 4580	614.65 655.11
		Medium Body	6" 4535 9" 4530	816.28 903.90			Medium Body	6" 4555 9" 4550	723.80 919.27
		Wide Body	6" 4505 9" 4500	857.77 954.67			Wide Body	6" 4525 9" 4520	800.35 972.10
Note: 1-1/2" Radius Corners are for use with Part #2055, 1-1/2" Retainer only. Body and retainers are cast aluminum.					Note: Tension Frame Radius Corners are for use with Parts #2085/#2095, Bleed Tension Frame and Bleed Tension Frame Cover only. The Covers are injection molded polycarbonate, pre-primed black and ready for paint/top coating.				
For Rigid Plastic or Flexible Faces Dual Frame w/ 2-1/4" Dual Frame Cover					For Flexible Faces Tension Frame II w/ Bleed Tension Frame Cover				
		Narrow S/F Body	6" 4475	622.45			Narrow S/F Body	6" 4488	647.07
		Single Face Body	6" 4575 9" 4570	622.45 665.70			Single Face Body	6" 4588 9" 4587	647.07 706.89
		Medium Body	6" 4545 9" 4540	869.60 940.40			Medium Body	6" 4558 9" 4557	790.18 1034.04
		Wide Body	6" 4515 9" 4510	916.92 993.24			Wide Body	6" 4528 9" 4527	860.41 1084.05
Note: Dual Frame Radius Corners are for use with either Part #2045, 2-1/4" Retainer or Parts #2065/#2075, Dual Frame with 2-1/4" Dual Frame Cover. The Covers are injection molded polycarbonate, pre-primed black and ready for paint/top coating.					Note: Tension Frame II Radius Corners are for use with Parts #2086/#2095, Tension Frame II and Bleed Tension Frame Cover only. The Covers are injection molded polycarbonate, pre-primed black and ready for paint/top coating.				

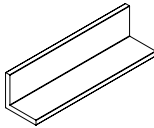
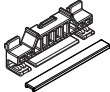
Note: The cast radius corner body is ground smooth and milled to fit the extrusion profile. Grind lines and imperfections are present. Some surface preparation may be necessary. **Not ready for paint.** All corners are mill finish and packaged four (4) per box, unless requested otherwise.

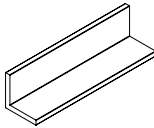
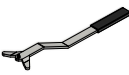

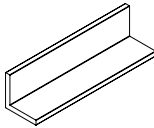
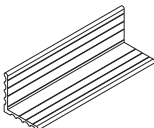









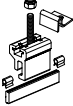

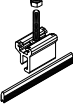









Commercial System Accessories

Part		Part Number	Price Each	Part		Part Number	Price Each
Components							
	Gas Support Included: (2) Gas Supports/Ball Stud Mounting Brackets (4) 10mm Ball Studs Screws for mechanical fastening Designed for SignComp Large Vandal only. Not recommended with other systems. Call Customer Service for specific gas support size and poundage.	5934-Kit				5934-Kit	\$110.61
Part	Part Number	Price Each	Part	Part Number	Price Each	Part Number	Price Each
	Corner Key 3-1/4" x 3-1/4" x .120 Stamped Aluminum	5210	\$1.55		Wide Body Raceway Cover 10-1/4" x 48" x .040 (white) Blank	5116	\$40.91
	2 Piece Corner Key 1-3/8" x 1-3/8" x .200 Stamped Steel	5890	0.98		Medium Body Raceway Cover 7-1/8" x 48" x .040 (white) Blank	5114	23.68
	Flat 1-1/2" Retainer Corner Bracket Set	5213	6.54		Single Face Body Raceway Cover 5-5/8" x 48" x .040 (white) Blank	5112	14.07
	Flat 2" Retainer Corner Bracket Set	5214	7.77		Wide Body Ballast Bracket 10-1/16" x 24" x .080	5092	16.02
	Frame Brace 1-3/8" Pieces	5350	3.23		Medium Body Ballast Bracket 6-13/16" x 24" x .080	5094	10.63
	Small Frame Brace 1-1/8" Pieces	5352	2.30		Single Face Body Ballast Bracket 5-9/16" x 24" x .080	5096	7.96
	Retro Frame Brace 1-1/8" Pieces (For non-hinged applications see page 38)	5354	2.86		Wide Body Corner Angle 1-3/4" x 1-3/4" x 1/4" (10-1/16")	5312	11.61
	2 Piece Frame Brace 1" Pieces	5357	10.86		Medium Body Corner Angle 1-3/4" x 1-3/4" x 1/4" (6-7/8")	5318	8.18
	Tension Clip 100 Count Bag	5360	150.00		Single Face Body Corner Angle 1-3/4" x 1-3/4" x 1/4" (5-9/16")	5322	7.35
	Tension Tool	5135	84.64		Narrow Single Face Body Corner Angle 1-3/4" x 1-3/4" x 1/4" (2-5/16")	5321	3.86
	Wall Mount Tension Tool	5137	84.64		Slimline Single Face/ 6" Tension Body Corner Angle 1-3/4" x 1-3/4" x 1/4" (7/8")	5320	2.50
	Reverse Wall Mount Tension Tool	5138	84.64		7" Single Face Tension Body Corner Angle 1-1/4" x 1-3/4" x 1/4" (3-11/16")	5324	6.90
					Flat 2 Piece Double Face Body Corner Angle 2-1/2" x 2-1/2" x 1/4" (15-9/16")	5909	20.49
					Flat 2 Piece Double Face Medium Body Corner Angle 2-1/2" x 2-1/2" x 1/4" (11-9/16")	5910	14.43
					Flat Double Face Body Corner Angle 2-1/2" x 2-1/2" x 1/4" (8-9/16")	5908	11.69
					Flat Double Face Medium Body Corner Angle 2-1/2" x 2-1/2" x 1/4" (3-13/16")	5907	6.03
					Flat Single Face Body Corner Angle 2-1/2" x 2-1/2" x 1/4" (5-5/8")	5327	7.96

Note: All dimensions are subject to the tolerance standards of the aluminum extrusion industry. Profile drawings are illustrative and rounded to the nearest 1/16".

























Commercial System Accessories

Part	Part Number	Price Each	Part	Part Number	Price Each		
Components							
	Reversible Flexholder 500 Count Box	LP-1100	\$550.00		Frame Corner Angle 1-3/4" x 1-3/4" x 1/4" (1-1/16")	5305	\$2.20
	Wedge Clamp Sets 1-1/2" Bolt - 100 Count Box	5365	492.00		Divider Corner Angle w/ Notch 1-3/4" x 1-3/4" x 1/4" (1-1/16")	5300	2.71
	2-1/2" Bolt - 100 Count Box	5370	505.00		Frame Corner Angle 2" x 2" x 3/16" (9/16") (For Part #2053)	5304	2.06
	Flexclamp 1-1/2" Bolt - 250 Count Box	FC	852.50		Divider Corner Angle w/ Notch 2" x 2" x 3/16" (9/16") (For Part #2053)	5301	2.58
	2-1/2" Bolt - 250 Count Box	FCSP	902.50		Front Load Wall Mount Tension Frame Corner Angle	5323	2.66
	Teeth Clip 500 Count Box	FHU-CLIP	95.00		1-3/4" x 1-3/4" x 1/4" (1-1/2")		
	Stainless Steel Clip 250 Count Box	SSC-P	182.50		2Part Outer Frame Corner Angle 2" x 2" x 1/8" (3/8")	5975	2.20
	3-1/2" Front Load Soft Signage Angle Assembly 2" x 2" x 1/4" (1/2")	5895	3.11		Corner Angle 2" x 2" x 3/16" (3/16")	5303	1.39
	2Part Lock For use with Parts #1942/#2099	5994	18.47		Insert Divider Tab 3/4" x 2" x .125"	5306	1.25
	2Part Large Lock For use with Parts #1941/#2097	5993	18.96		1-1/4" Divider Tab 1" x 2-1/4" x .125"	5308	1.25
	2Part Lock Wrench For use with Part #5994	5992	15.23		Flat Divider Mounting Bracket 50 Count Box	5302	131.50
	2Part Hinge 1-1/16" x 96" x .060 Aluminum Hinge	5996 *5996P	30.00 54.00		Front Load Soft Signage Pull Tab Assembly	5897	3.54
	2Part Large Hinge 1-1/2" x 96" x .063 Aluminum Hinge	5997 *5997P	42.86 67.18		Compression Gasket Self adhesive water exclusion gasket 50' roll	5500	23.53
	D-Punch Assembly	5080	616.66		6" Radius End Cap 1-1/4" Reveal Tab	5440	29.47

**Anodized Dark Bronze

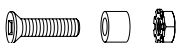
Commercial System Accessories

Current pricing available at www.signcomp.com or call SignComp Customer Service 877-784-0405

Part	Part Number	Price Each
Hardware		
 Access Frame Cover Screw Pre-drill and countersink 1/8" holes 12" o/c	5168	\$14.00/100
 Flat Bleed Rigid Retainer Screw Pre-drill and countersink 1/8" holes four (4) per corner		
 Divider Tab Screw Pre-drill 1/8" holes one (1) per divider end #8 x 1/2" stainless steel square/phillips drive countersink screw - Type A		
 Hinge Screw Pre-drill 3/8" holes through the retainer along top 36" o/c	5170	62.00/100
 Dual Divider Cover Screw Pre-drill 3/8" holes through the cover 48" o/c 1/4"-20 x 1/2" stainless steel allen head machine screw		
 Flat Body Hinge Screw Pre-drill 5/32" holes along top of retainer 36" o/c	5178	34.00/100
 Flat Body Closure Screw Pre-drill 5/32" holes along sides and bottom of retainer 48" o/c #10 x 5/8" steel zinc square/phillips drive pancake head screw - Type B		
 Closure Screw Pre-drill 3/8" holes along sides and bottom of retainer 48" o/c 1/4"-20 x 3/4" stainless steel square/phillips drive pan head machine screw	5180	42.00/100
 Cover Screw Pre-drill 1/8" holes 24" o/c	5195	18.00/100
 Retainer Screw Pre-drill 1/8" holes in back through retainer into corner keys four (4) per corner		
 Corner Bracket Screw Pre-drill 1/8" holes in bottom through retainer into corner brackets four (4) per corner #8 x 5/16" steel zinc square/phillips drive pan head screw - Type B		
 Flat Single Face Body Corner Angle Screw Pre-drill 1/8" holes eight (8) per corner #8 x 3/8" steel zinc square drive pan head screw - Type B	5199	16.00/100
 Wall Mount Tension Frame Cover Screw Pre-drill 1/8" holes 24" o/c #8 x 3/4" steel zinc square/phillips drive pan head screw - Type B	5215	44.00/100
 Corner Angle / Divider Angle Screw Pre-drill 5/32" holes Four (4) per body corner and two (2) per retainer corner / Two (2) per divider end	5218	38.00/100
 Radius Corner Screw Four (4) per corner #10 x 1/2" stainless steel square/phillips drive pan head tapping screw w/ wax - Type AB		
 Inner Frame Retainer Screw Pre-drill and countersink 1/8" holes two (2) per corner #8 x 3/4" stainless steel square/phillips drive countersink screw - Type A	5241 5241P	12.00/100 29.00/100
 Access Frame Corner Screw Pre-drill and countersink 1/8" holes two (2) per corner on verticals	5270	29.00/100
 Flat Bleed Double Face Tension Cover Screw #8 x 1-1/2" stainless steel square/phillips drive countersink screw - Type A		
 Rigid Retainer Hardware Pre-drill and countersink 9/32" holes 18" o/c 1/4"-20 x 1" stainless steel square drive countersink machine screw/bushing/lock nut	5285	1.29/ea
 Raceway Cover Screw Pre-drill 1/8" holes 24" o/c #8 x 1/2" steel zinc square/phillips drive pan head screw - Type A	5290	16.00/100
 2Part Large Hinge Screw Pre-drill and countersink 1/8" holes 3" o/c - first 18", remainder 6-8" o/c	5990	12.00/100
 2Part Outer Frame Corner Angle Screw Pre-drill and countersink 1/8" holes two (2) per corner #8 x 3/8" stainless steel square/phillips drive countersink screw - Type A		

*Anodized Dark Bronze

Note: All dimensions are subject to the tolerance standards of the aluminum extrusion industry. Profile drawings are illustrative and rounded to the nearest 1/16".

Commercial System Configurations with Reveal

Rigid Plastic or Flush Aluminum Faces

1-1/2" Retainer

#2055

Wide Body
#2005

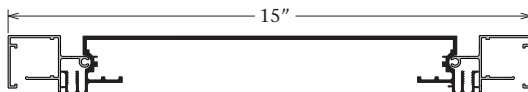

Medium Body
#2015

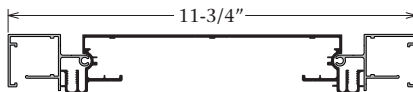

Single Face Body
#2025

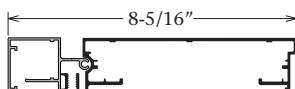

Narrow Single Face Body
#2021

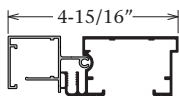

Slimline Single Face Body
#2020

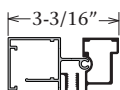

Retro Body
#2040

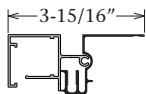

Note: When bonding an aluminum face to the retainer, the overall dimension of the configurations may vary depending on the face thickness used.

1-1/2" Retainer II

#2053

Wide Body
#2005

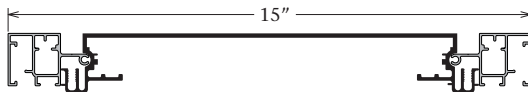

Medium Body
#2015

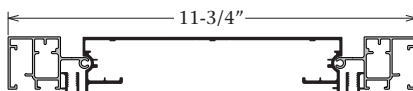

Single Face Body
#2025

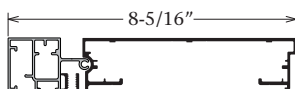

Narrow Single Face Body
#2021

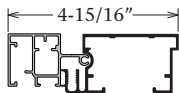

Slimline Single Face Body
#2020

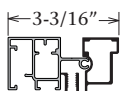

Retro Body
#2040

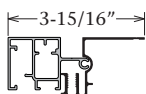

Note: The overall dimension of the configurations when bonding an aluminum face to the retainer, may vary depending on the face thickness used.

Commercial System Configurations with Reveal

Rigid Plastic or Flush Aluminum Faces

2-1/4" Retainer

#2045

Wide Body

#2005

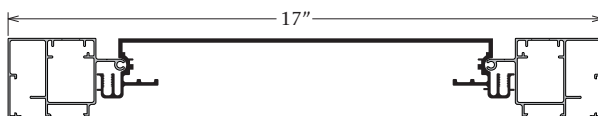

Medium Body

#2015

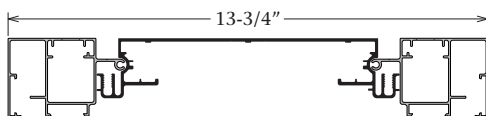

Single Face Body

#2025

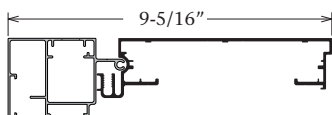

Narrow Single Face Body

#2021

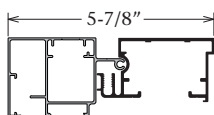

Slimline Single Face Body

#2020

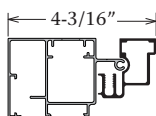

Retro Body

#2040

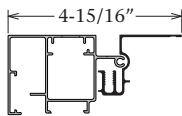

Note: The overall dimension of the configurations when bonding an aluminum face to the retainer, may vary depending on the face thickness used.

Rigid Plastic Faces or Flexible Faces

Dual Frame

with 2-1/4" Dual Frame Cover

#2065/#2075

Wide Body

#2005

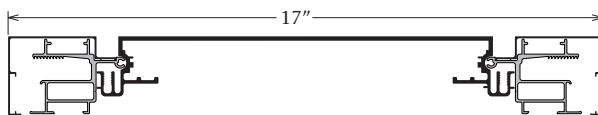

Medium Body

#2015

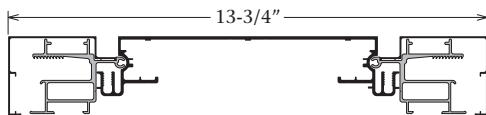

Single Face Body

#2025

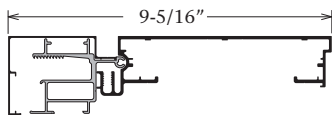

Narrow Single Face Body

#2021

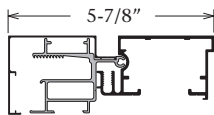

Slimline Single Face Body

#2020

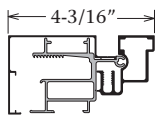

Retro Body

#2040

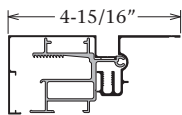

Note: All dimensions are subject to the tolerance standards of the aluminum extrusion industry. Profile drawings are illustrative and rounded to the nearest 1/16".

Commercial System Configurations with Reveal

For Bleed Pan Form Faces

Bleed Rigid Retainer

#2048

Wide Body

#2005

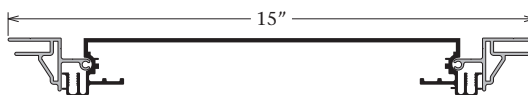

Medium Body

#2015

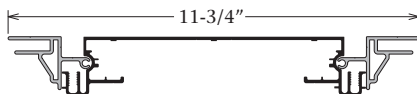

Single Face Body

#2025

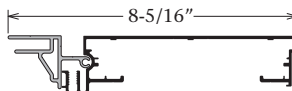

Narrow Single Face Body

#2021

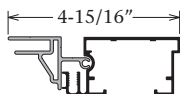

Slimline Single Face Body

#2020

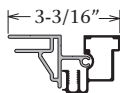

Retro Body

#2040

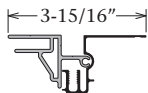

Insert Panels

Commercial Access Frame

with Insert Top/Bottom Cover

#2060/#1292

Wide Body

#2005

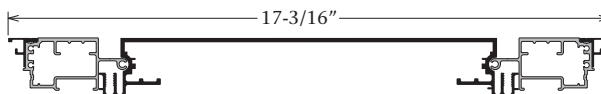

Medium Body

#2015

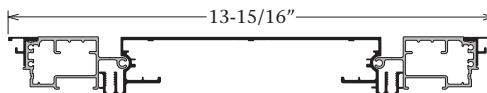

Single Face Body

#2025

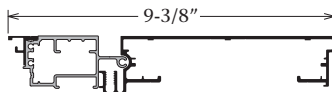

Narrow Single Face Body

#2021

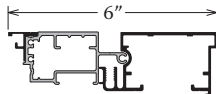

Slimline Single Face Body

#2020

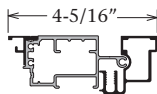

Retro Body

#2040

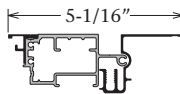

Optional Covers



#1692



#1693



#1694



#1695

Note: Part #2060 was engineered to integrate with Architectural System covers. See page 29 for optional covers.

Commercial System Configurations with Reveal

Flexible Faces

Tension Frame II
with Bleed Tension Frame Cover
#2086/#2095

Wide Body
#2005

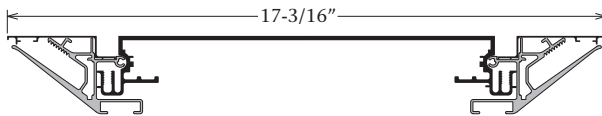

Medium Body
#2015

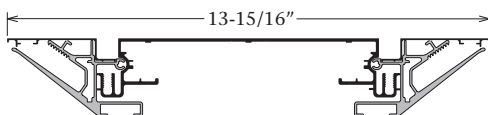

Single Face Body
#2025

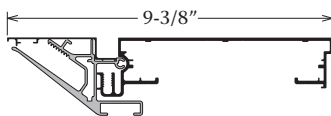

Narrow Single Face Body
#2021

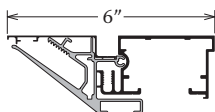

Slimline Single Face Body
#2020

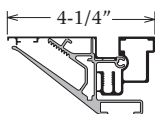

Retro Body
#2040

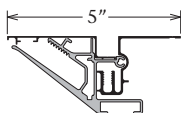

Tension Frame II
with 1-1/2" Tension Frame Cover
#2086/2084

Wide Body
#2005

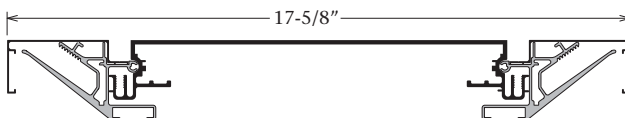

Medium Body
#2015

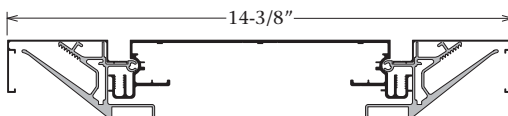

Single Face Body
#2025

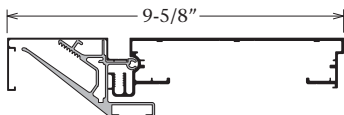

Narrow Single Face Body
#2021

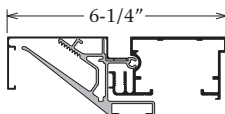

Slimline Single Face Body
#2020

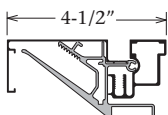

Retro Body
#2040

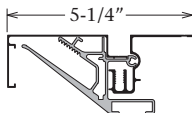

Note: All dimensions are subject to the tolerance standards of the aluminum extrusion industry. Profile drawings are illustrative and rounded to the nearest 1/16".

Commercial System Configurations with Reveal

Flexible Faces

Tension Frame

with Bleed Tension Frame Cover

#2085/#2095

Wide Body

#2005

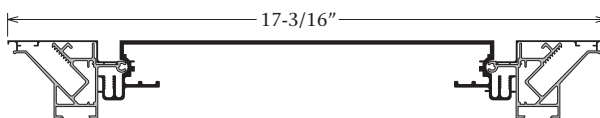

Medium Body

#2015

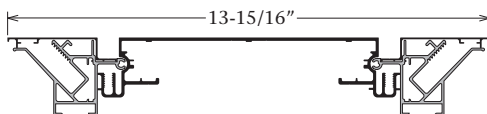

Single Face Body

#2025

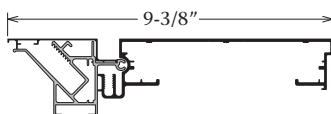

Narrow Single Face Body

#2021

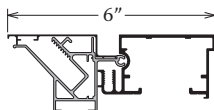

Slimline Single Face Body

#2020

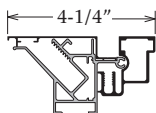

Retro Body

#2040

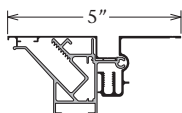

Tension Frame

with 1-1/2" Tension Frame Cover

#2085/#2084

Wide Body

#2005

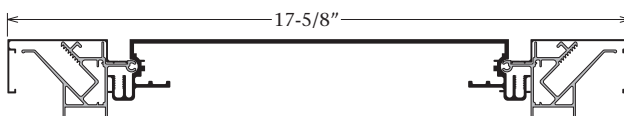

Medium Body

#2015

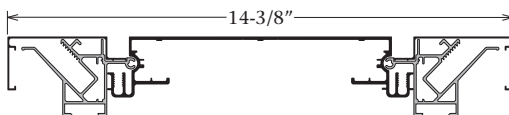

Single Face Body

#2025

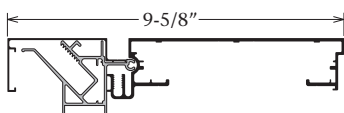

Narrow Single Face Body

#2021

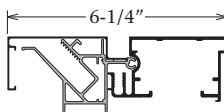

Slimline Single Face Body

#2020

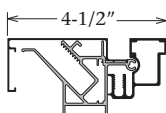

Retro Body

#2040

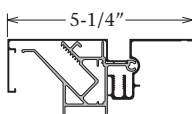

Commercial System Configurations with Reveal

Vandal Retainers

Inner Frame Retainer

with 2Part Outer Frame

#2099/#1942

Wide Body

#2005

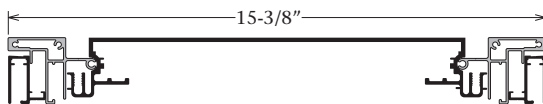

Medium Body

#2015

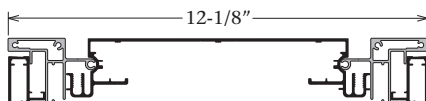

Single Face Body

#2025

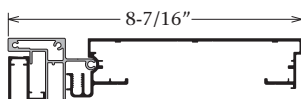

Narrow Single Face Body

#2021

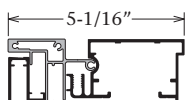

Slimline Single Face Body

#2020

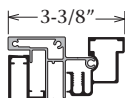

Retro Body

#2040

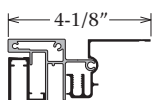

Large Inner Frame Retainer

with 2Part Large Outer Frame Retainer

#2097/#1941

Wide Body

#2005

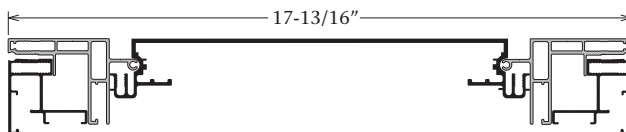

Medium Body

#2015

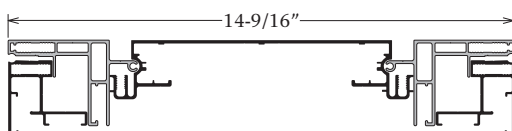

Single Face Body

#2025

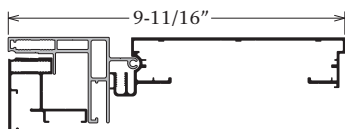

Narrow Single Face Body

#2021

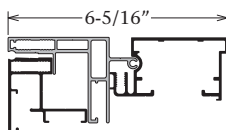

Slimline Single Face Body

#2020

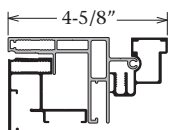

Retro Body

#2040

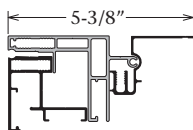

Note: All dimensions are subject to the tolerance standards of the aluminum extrusion industry. Profile drawings are illustrative and rounded to the nearest 1/16".

Commercial System Configurations without Reveal

Rigid Plastic Faces

Flat 1-1/2" Retainer

#2052

Flat 2 Piece
Double Face Body
#2009

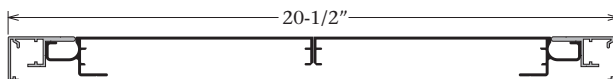

Flat 2 Piece
Double Face Medium Body
#2010

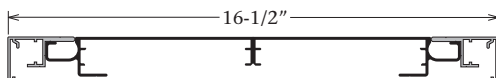

Flat Double Face Body
#2008

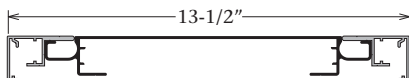

Flat Double Face
Medium Body
#2007

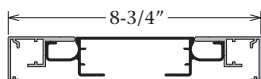

Flat Single Face Body
#2027

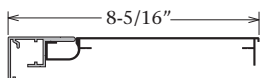

Flat Wall Mount
Retro Body
#2042

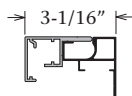

Flat Retro Body
#2041

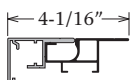

Flat 2" Retainer

#2047

Flat 2 Piece
Double Face Body
#2009

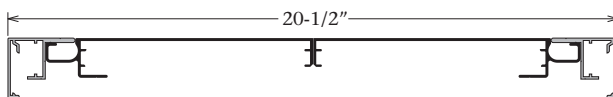

Flat 2 Piece
Double Face Medium Body
#2010

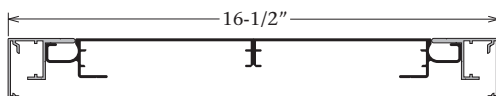

Flat Double Face Body
#2008

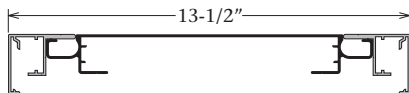

Flat Double Face
Medium Body
#2007

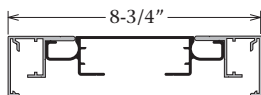

Flat Single Face Body
#2027

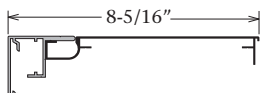

Flat Wall Mount
Retro Body
#2042

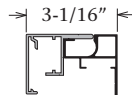

Flat Retro Body
#2041

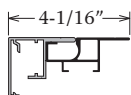

Commercial System Configurations without Reveal

Bleed Pan Form Faces

Flat Bleed Rigid Retainer

#2204

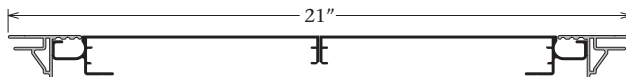

Flat 2 Piece Double Face Body

#2009

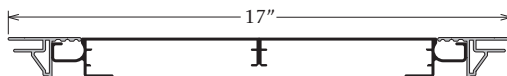

Flat 2 Piece Double Face Medium Body

#2010

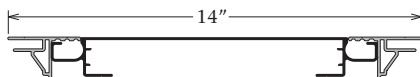

Flat Double Face Body

#2008

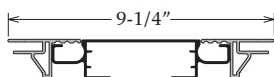

Flat Double Face Medium Body

#2007

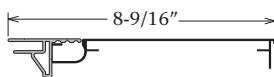

Flat Single Face Body

#2027

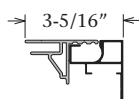

Flat Wall Mount Retro Body

#2042

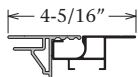

Flat Retro Body

#2041

Flexible Faces

Flat Bleed Retro Frame

with Flat Bleed Retro Frame Cover

#2104/#2121

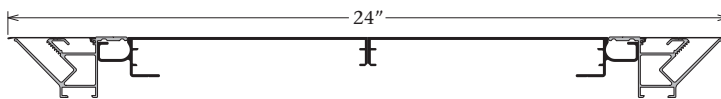

Flat 2 Piece Double Face Body

#2009

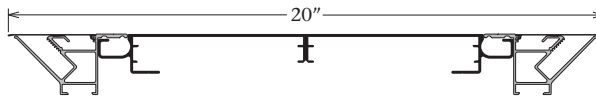

Flat 2 Piece Double Face Medium Body

#2010

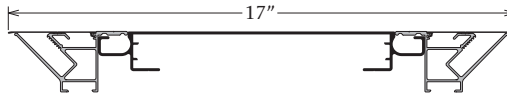

Flat Double Face Body

#2008

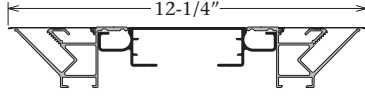

Flat Double Face Medium Body

#2007

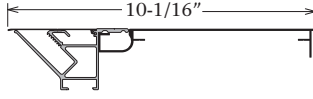

Flat Single Face Body

#2027

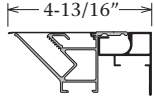

Flat Wall Mount Retro Body

#2042

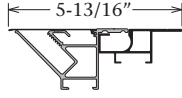

Flat Retro Body

#2041

Note: All dimensions are subject to the tolerance standards of the aluminum extrusion industry. Profile drawings are illustrative and rounded to the nearest 1/16".

Commercial System Configurations without Reveal

Flexible Faces

Flat Bleed Retro Frame II
with Flat Bleed Retro Frame Cover
#2107/#2121

Flat 2 Piece
Double Face Body
#2009

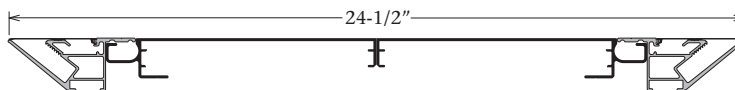

Flat 2 Piece
Double Face Medium Body
#2010

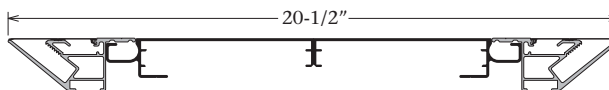

Flat Double Face Body
#2008

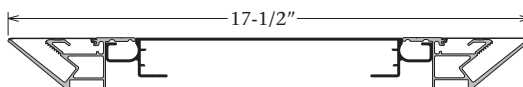

Flat Double Face
Medium Body
#2007

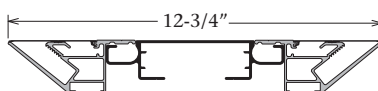

Flat Single Face Body
#2027

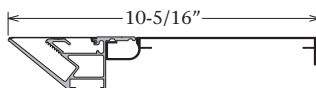

Flat Wall Mount
Retro Body
#2042

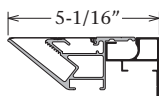

Flat Retro Body
#2041

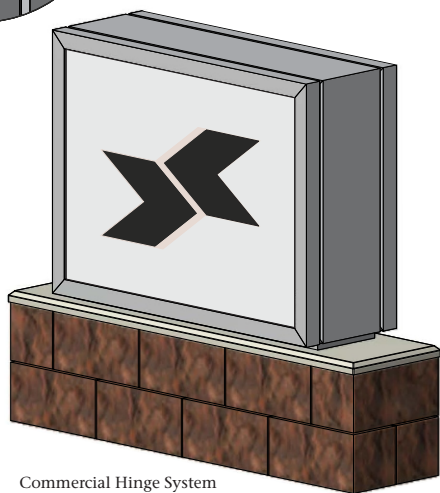
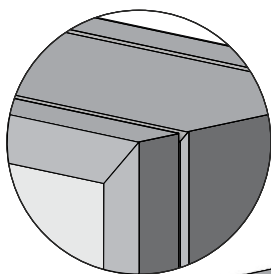
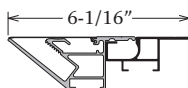

Commercial Hinge System
with Reveal

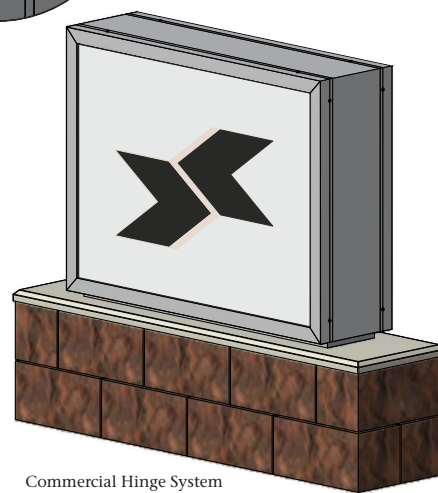
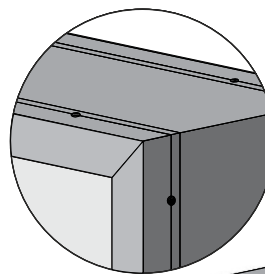

Commercial Hinge System
without Reveal

Commercial System Specifications

Sign Cabinet Bodies

with Reveal

Note: It is recommended to cut bodies and retainers 1" over nominal T12/T8 lamp length to utilize .040 flat aluminum raceway covers for Part #2005, #2015 and #2025.

Wide Body
Part #2005
(Section view through top)

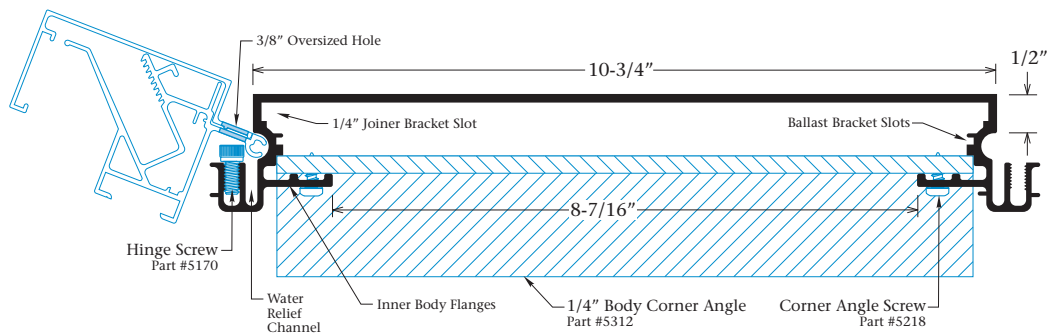

Medium Body
Part #2015
(Section view through top)

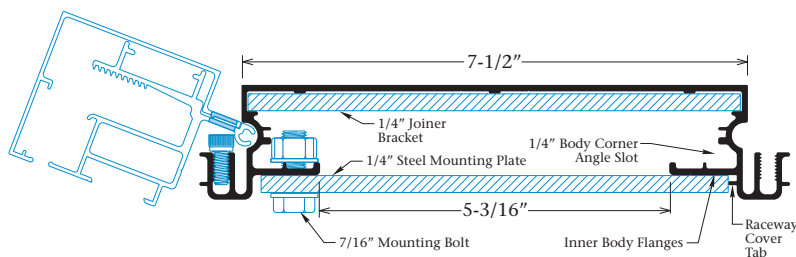

Single Face Body
Part #2025
(Section view through top)

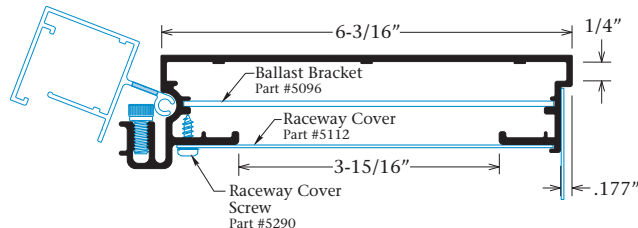

Narrow Single Face Body
Part #2021
(Section view through side/bottom)

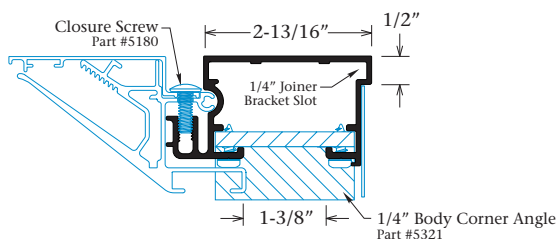

Slimline Single Face Body
Part #2020
(Section view through side/bottom)

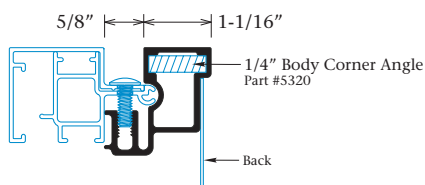

Retro Body
Part #2040
(Section view through side/bottom)

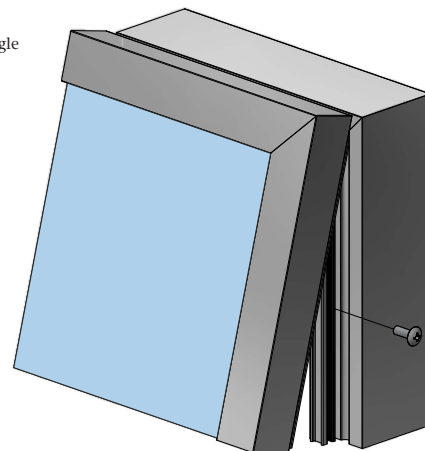
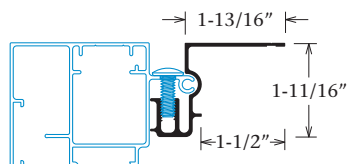

Note: See page 12 for all body components.

Note: Attach the 1/4" steel mounting plate above the inner body flanges to increase structural connection. It is recommended to use safety chains and prop-bars on all hingeable faces.

US Patent Numbers 6,061,941 / 6,637,080
CA Patent Numbers 2,245,623 / 2,387,222

Note: All dimensions are subject to the tolerance standards of the aluminum extrusion industry. Profile drawings are illustrative and rounded to the nearest 1/16".

Commercial System Specifications

Sign Cabinet Bodies

Note: It is recommended to cut bodies and retainers 1" over nominal T12/T8 lamp length to utilize .040 flat aluminum raceway covers for Part #2009, #2010, #2008 and #2007. Contact Customer Service for Part #2027.

without Reveal

Flat 2 Piece Double Face Body

Part #2009

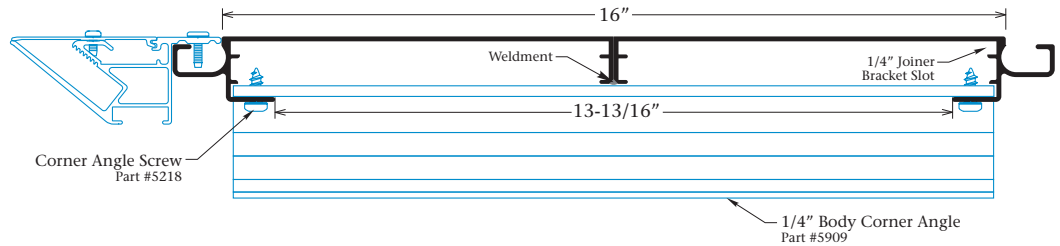

Flat 2 Piece Double Face Medium Body

Part #2010

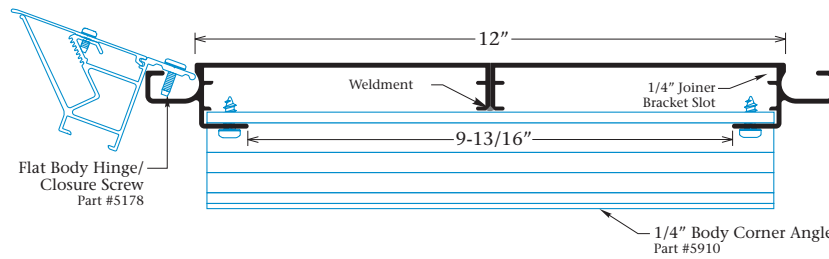

Flat Double Face Body

Part #2008

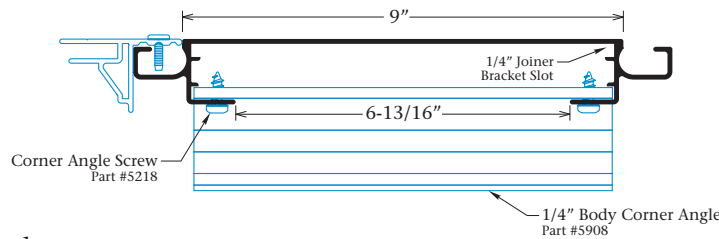

Flat Double Face Medium Body

Part #2007

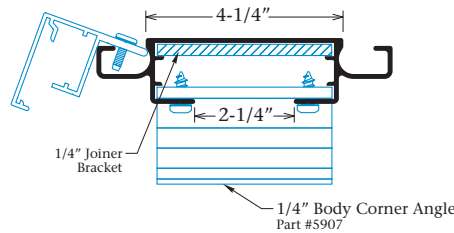

Flat Single Face Body

Part #2027

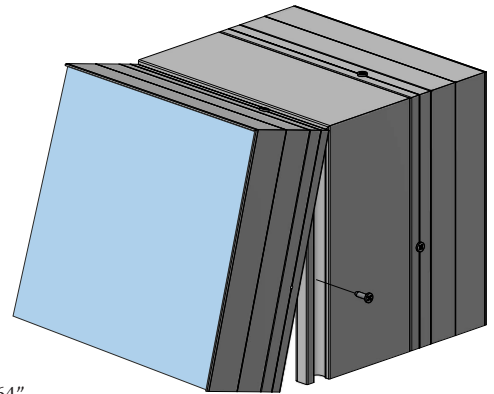
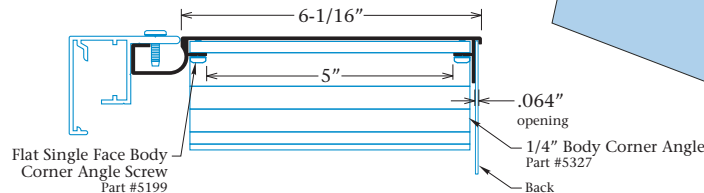

Flat Wall Mount Retro Body

Part #2042

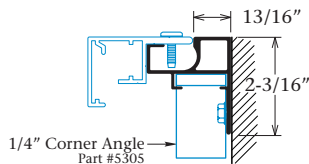

Flat Retro Body

Part #2041

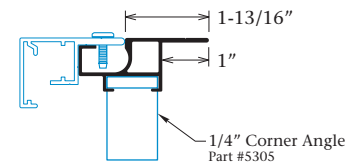

Note: See page 12 for all body components.

Note: Attach the 1/4" steel mounting plate above the inner body flanges to increase structural connection. It is recommended to use safety chains and prop-bars on all hingeable faces.

US Patent Numbers 9,208,701 / 6,061,941 / 6,637,080
CA Patent Numbers 2,245,623 / 2,387,222

Commercial System Specifications

Hingeable Retainers and Covers

For Rigid Plastic Faces

1-1/2" Retainer
Part #2055

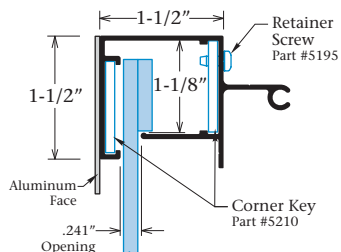

1-1/2" Retainer II
Part #2053

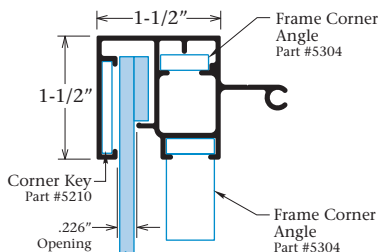

1-1/2" Frame
Part #2063

1-1/2" Frame Cover
Part #2073

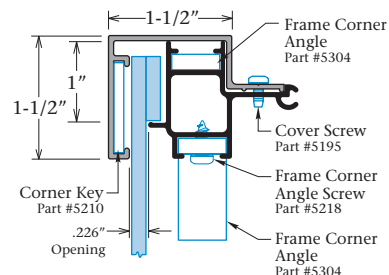

2-1/4" Retainer
Part #2045

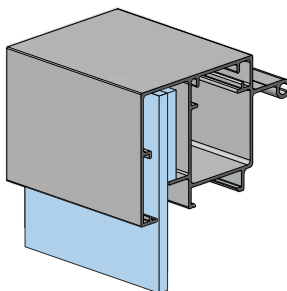
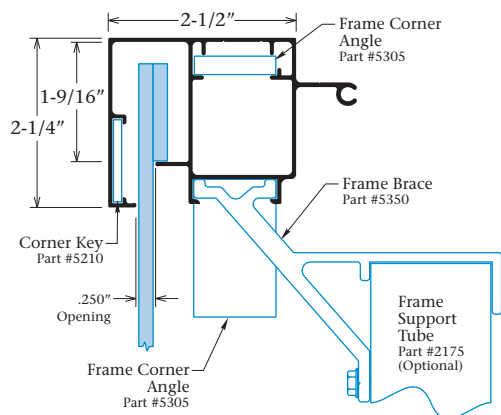

Dual Frame
Part #2065

2-1/4" Dual Frame Cover
Part #2075

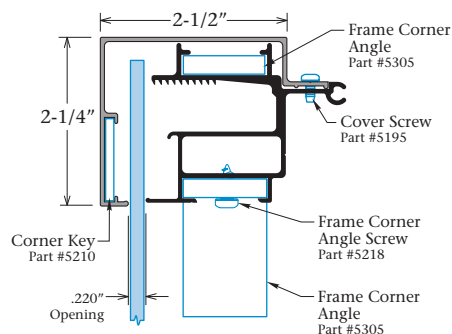

Note: The Dual Frame with 2-1/4" Dual Frame Cover and the 1-1/2" Frame with 1-1/2" Frame Cover for Rigid Plastic Faces, is engineered to be used on the sides of the cabinet in conjunction with the 2-1/4" Retainer or 1-1/2" Retainer II. This will allow the covers to be removed in order to slide the face in and out.

Flat 1-1/2" Retainer
Part #2052

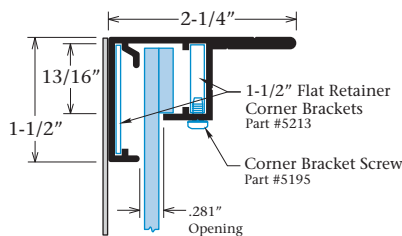

Flat 2" Retainer
Part #2047

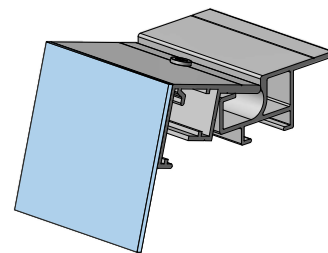
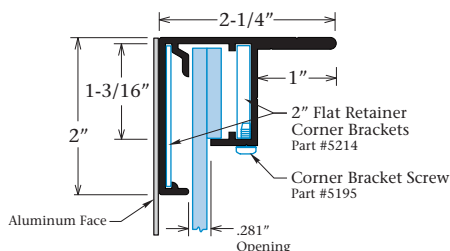

Note: Parts #2052, #2047 and #2204 are engineered to integrate with the Flat Body System. See page 24

For Bleed Pan Form Faces

Bleed Rigid Retainer
Part #2048

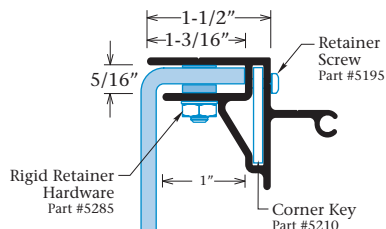

Flat Bleed Rigid Retainer
Part #2204

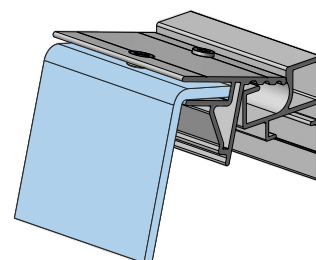
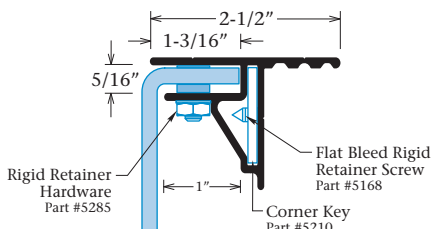

Note: It is recommended to use safety chains and prop-bars on all hingeable faces.

US Patent Numbers 6,061,941 / 6,637,080
CA Patent Numbers 2,245,623 / 2,387,222

Note: All dimensions are subject to the tolerance standards of the aluminum extrusion industry. Profile drawings are illustrative and rounded to the nearest 1/16".

Commercial System Specifications

Hingeable Retainers For Flexible Faces

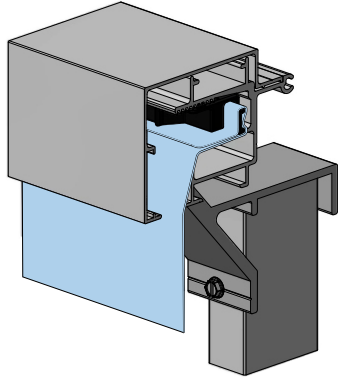

Dual Frame
Part #2065
2-1/4" Dual Frame Cover
Part #2075

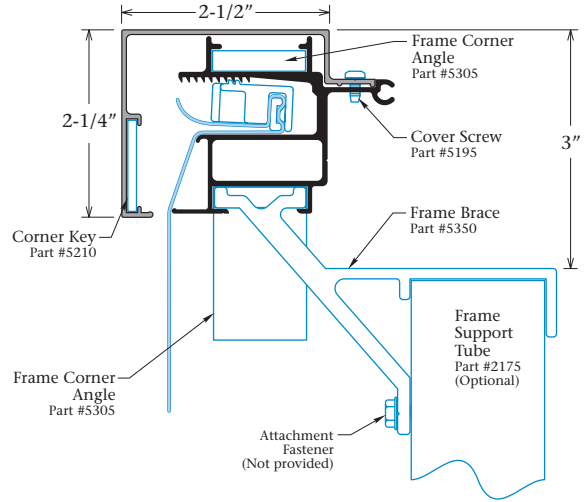

Tension Frame II
Part #2086
Bleed Tension Frame Cover
Part #2095

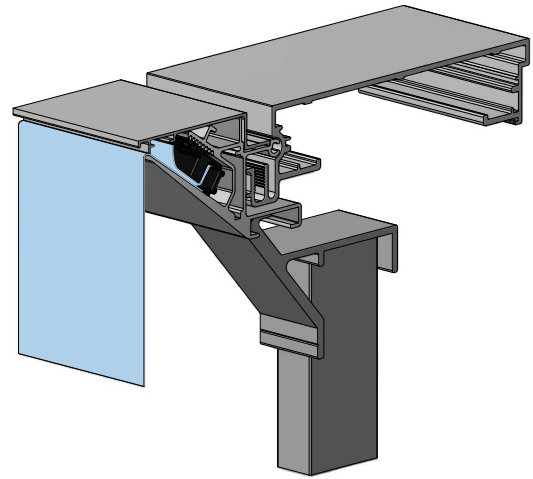
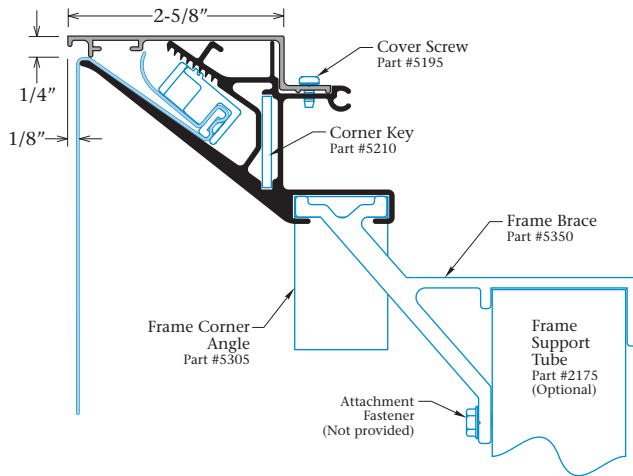

Tension Frame
Part #2085
1-1/2" Tension Frame Cover
Part #2084

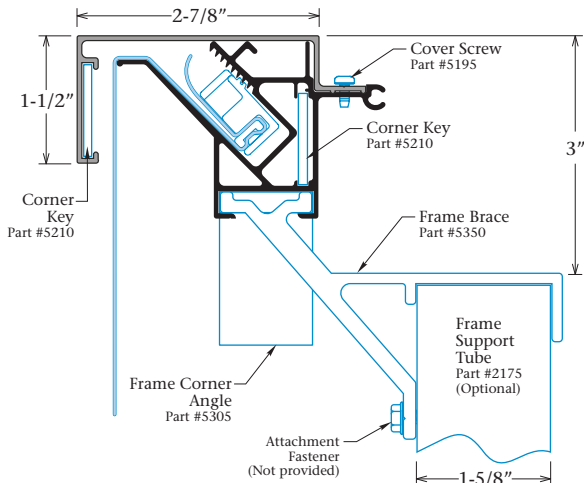

Bleed Tension Frame Cover
Part #2095

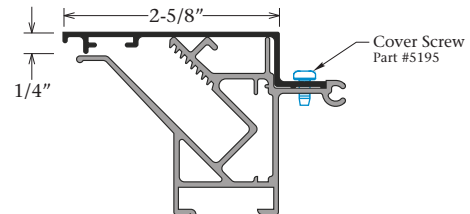

Note: Part #2084 works with both Part #2085, Tension Frame and Part #2086, Tension Frame II.

Commercial System Specifications

Dividers

For Rigid Plastic Faces

1-1/2" Divider

Part #2133
(For use with Part #2053)

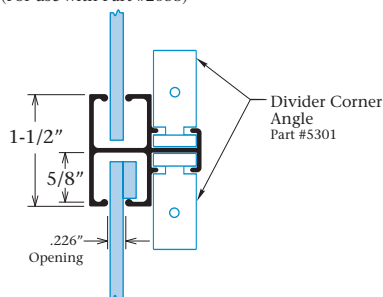

2" Divider

Part #2138

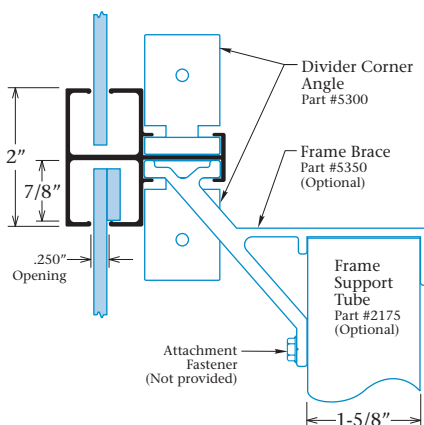

2-3/4" Divider

Part #2128

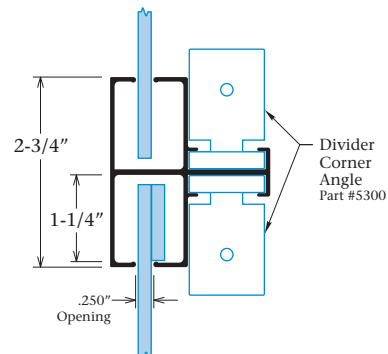

Flat 2" Divider

Part #2130

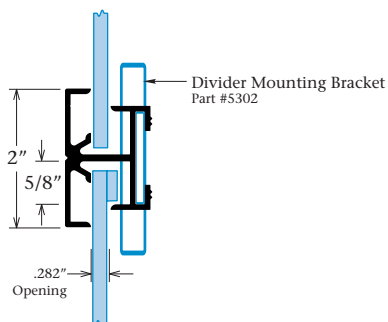

For Flexible Faces and/or Rigid Plastic Faces

Dual Divider

Part #2142

2-1/2" Dual Divider Cover

Part #2146

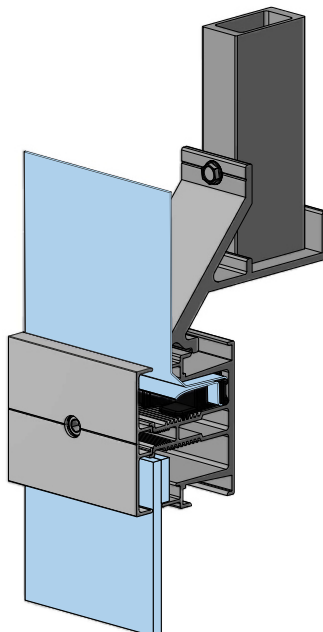
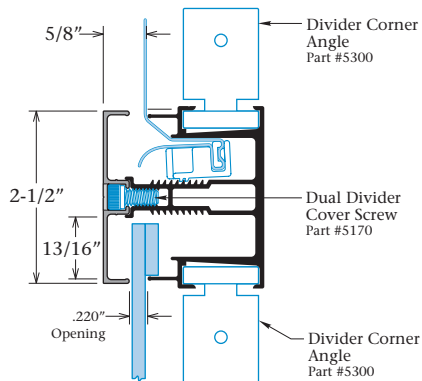

Dual Divider

Part #2142

2-1/2" Dual Divider Cover

Part #2146

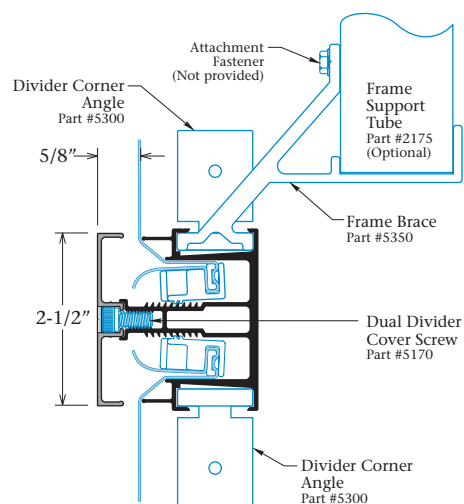

Note: All dimensions are subject to the tolerance standards of the aluminum extrusion industry. Profile drawings are illustrative and rounded to the nearest 1/16".

Commercial System Specifications

Hingeable Retainers Vandal System

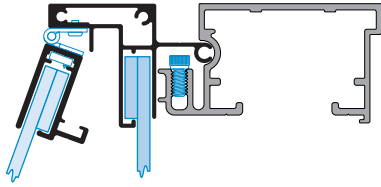

2Part Outer Frame
Part #1942

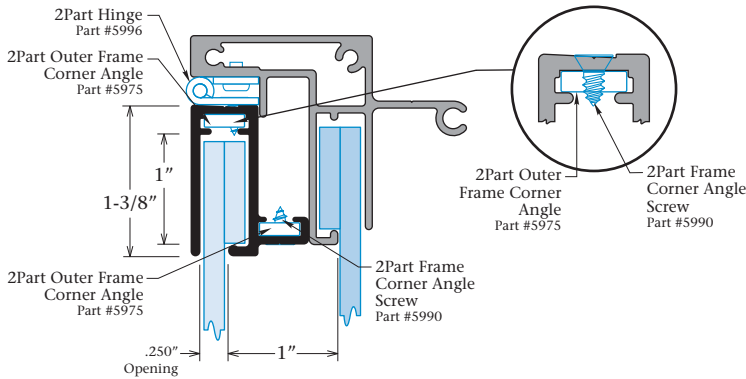

Inner Frame Retainer
Part #2099

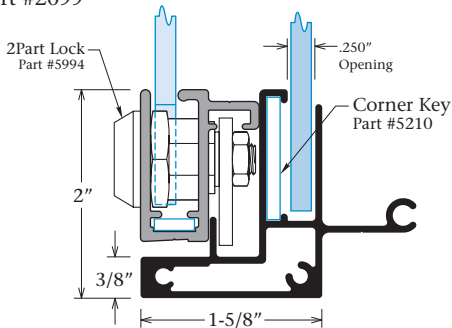

Large Vandal System with Gas Support

Large Inner Frame Retainer & 2Part Large Outer Frame
Part #2097 Part #1941

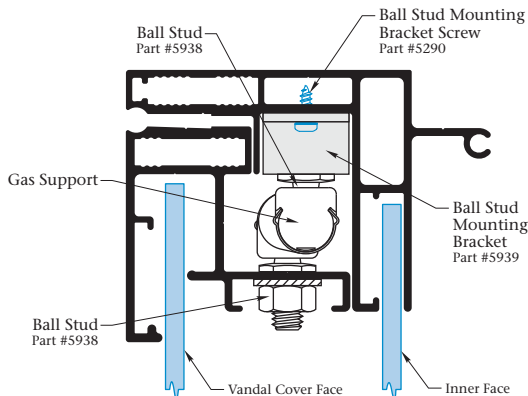

Large Vandal System

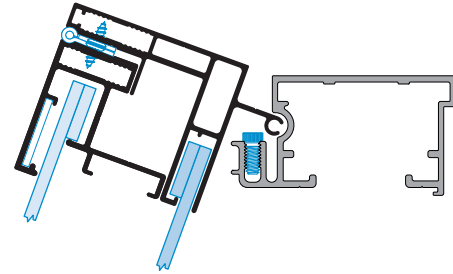

2Part Large Outer Frame
Part #1941

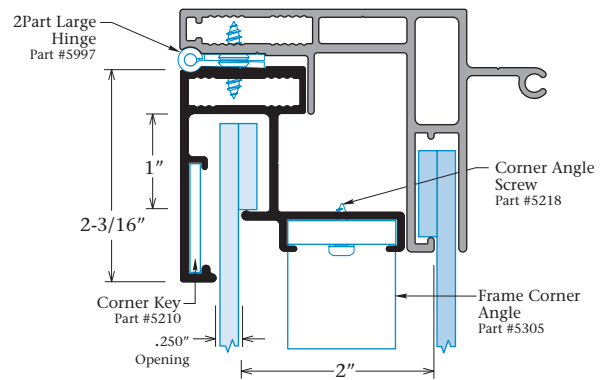

Large Inner Frame Retainer
Part #2097

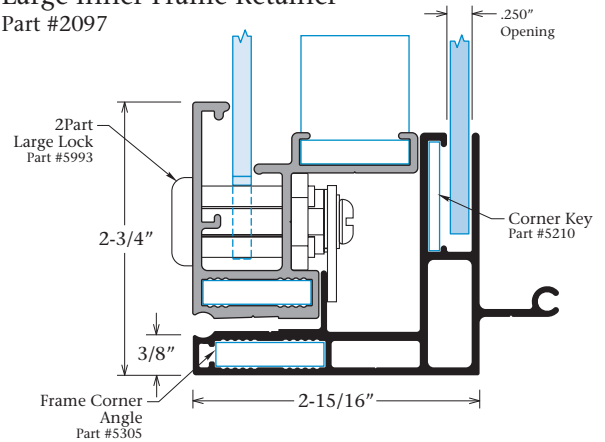

Note:

The **Inner Frame** retains the inner face which is typically a translucent white face for changeable copy systems.

The **Outer Frame** retains the vandal cover or outer face which is typically a clear lens.

Call Customer Service at 877-784-0405 for specific gas support size and poundage.

Note: It is recommended to use safety chains and prop-bars on all hingeable faces.

Commercial System Specifications

Hingeable Retainers

For Insert Panels

Commercial Access Frame
Part #2060

Insert Top/Bottom Cover
Part #1292

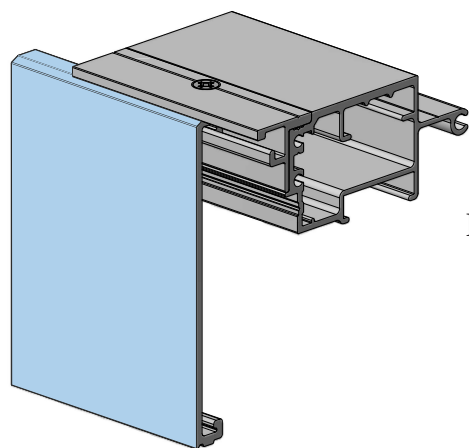
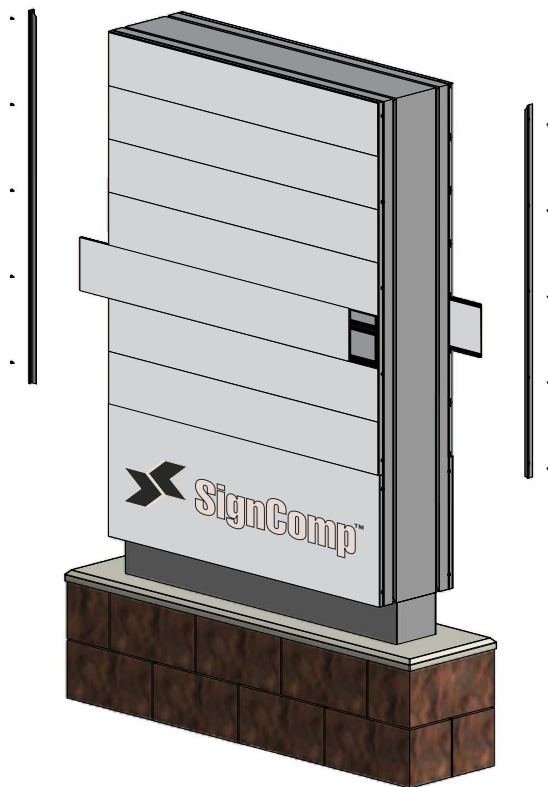
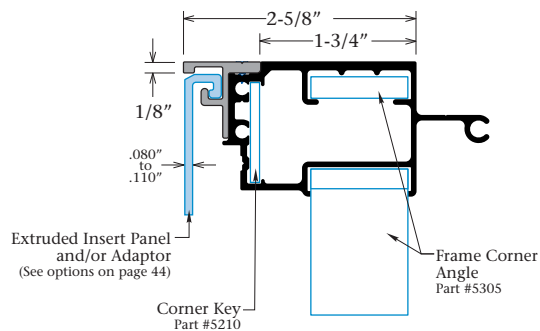

Flush Insert Panel Divider
Insert Divider
Part #1668

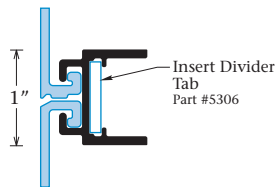

Framed Face Divider
1-1/4" Divider
Part #1662

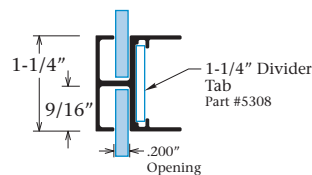

Optional Covers for Commercial Access Frame

Bleed Cover
Part #1692

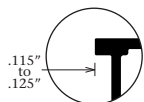
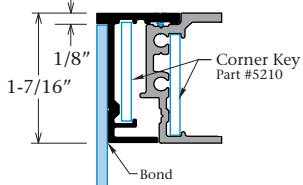

Frameless Cover
Part #1693

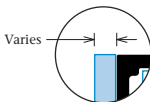
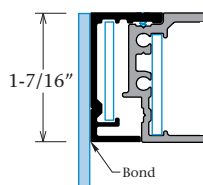

Slide Cover
Part #1694

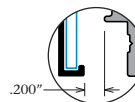
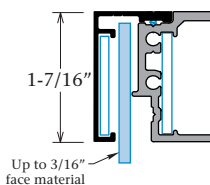

Radius Slide Cover
Part #1695

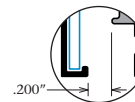
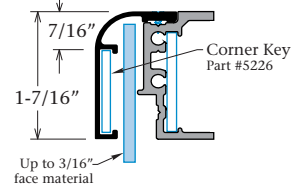

Note: The Commercial Access Frame was engineered to integrate with Architectural System covers. See pages 43, 44, 65 and 66 for more information.

Note: All dimensions are subject to the tolerance standards of the aluminum extrusion industry. Profile drawings are illustrative and rounded to the nearest 1/16".

Commercial System Specifications

Radius Ends

6" Radius 1/4 Round End
Part #1671

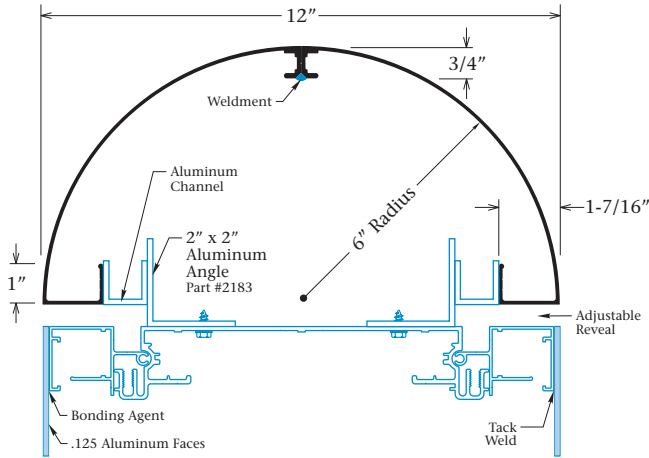

Medium Body and 1-1/2" Retainer

6" Radius 1/4 Round Pole Cover
Part #1672

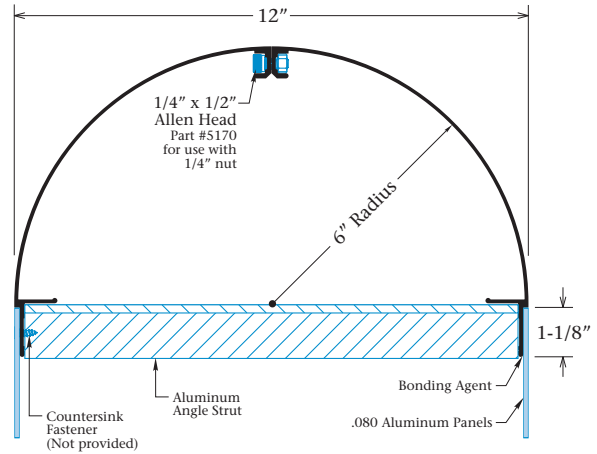

Note: 1671 and 1672 require two (2) 1/4 rounds to make one half round.

8-1/2" Radius 3 Part End
Part #1673

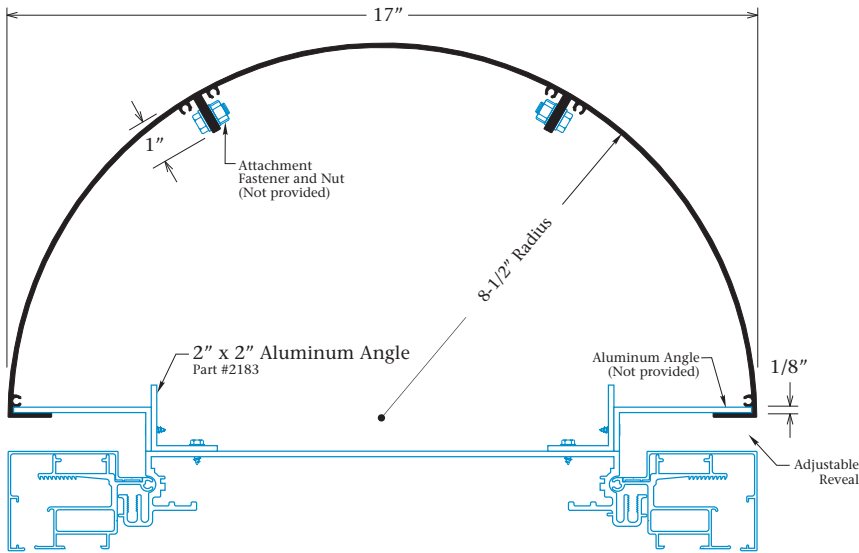

Wide Body and Dual Frame with 2-1/4" Dual Frame Cover

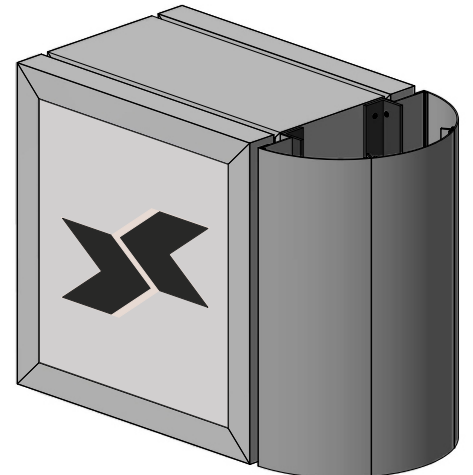

Note: Part #1673 requires three (3), 3 Part Ends to make one half round.

Commercial System Specifications

Tension Bodies and Covers

For Flexible Faces

5" Flat Bleed Double Face Tension Body
Part #2230

5" Flat Bleed Double Face Tension Cover
Part #2235

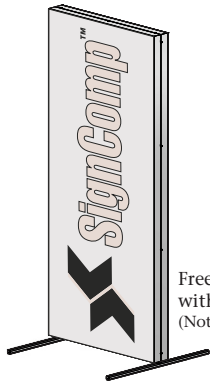
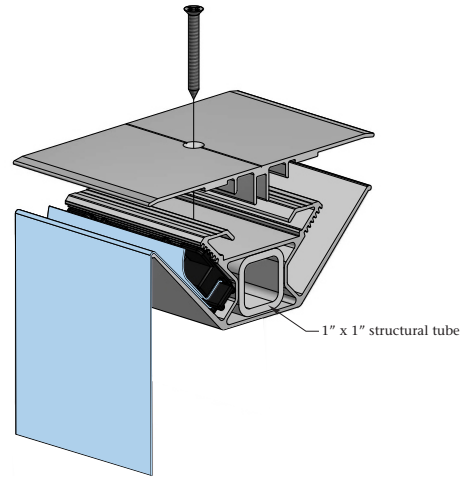
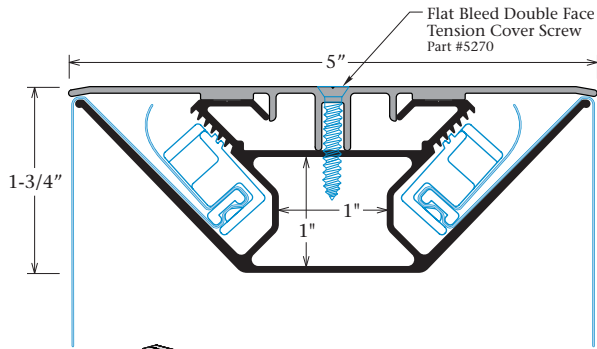

Freestanding with structural tube (Not provided by SignComp)

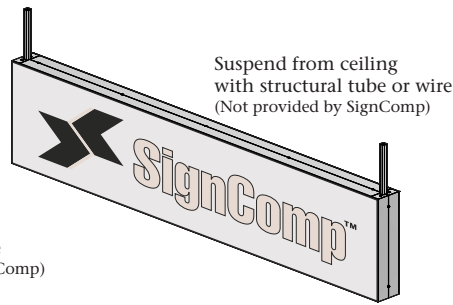

Suspend from ceiling with structural tube or wire (Not provided by SignComp)

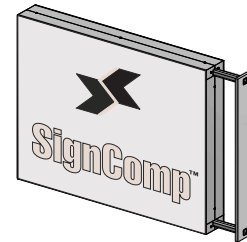

Cantilever off walls with structural tube (Not provided by SignComp)

6" Flat Bleed Single Face Tension Body
Part #2233

6" Flat Bleed Single Face Tension Cover
Part #2238

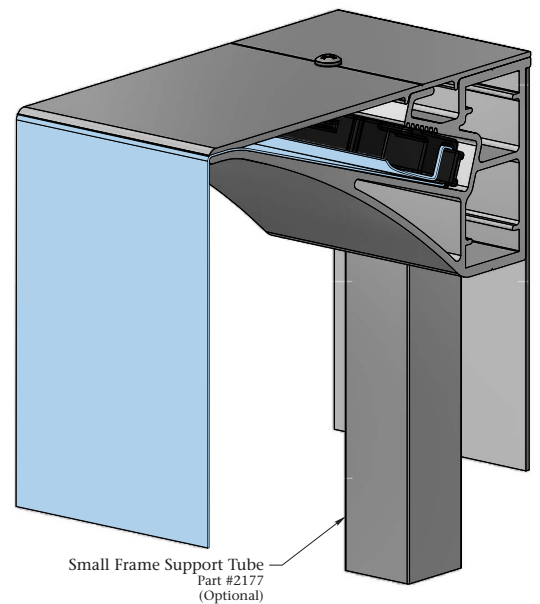
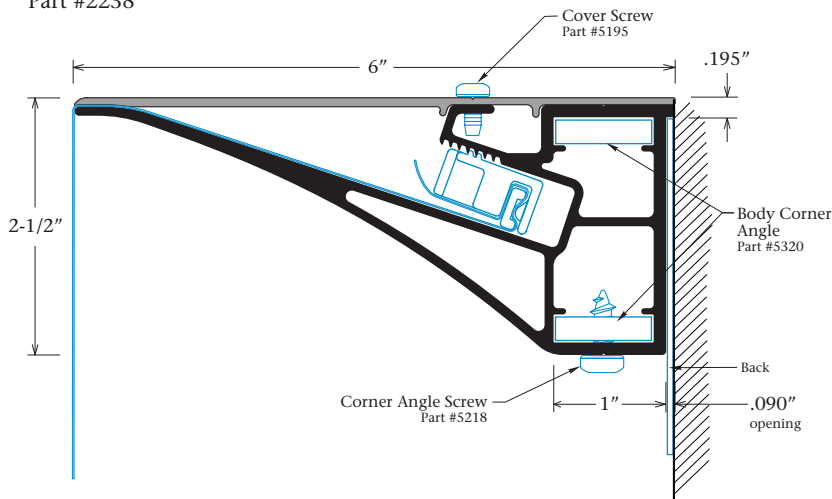

Small Frame Support Tube Part #2177 (Optional)

Note: All dimensions are subject to the tolerance standards of the aluminum extrusion industry. Profile drawings are illustrative and rounded to the nearest 1/16".

Commercial System Specifications

Retro / Tension Frames and Covers

For Flexible Faces

2" Retro Frame
Part #2112
2-3/8" Retro Frame Cover
Part #2115

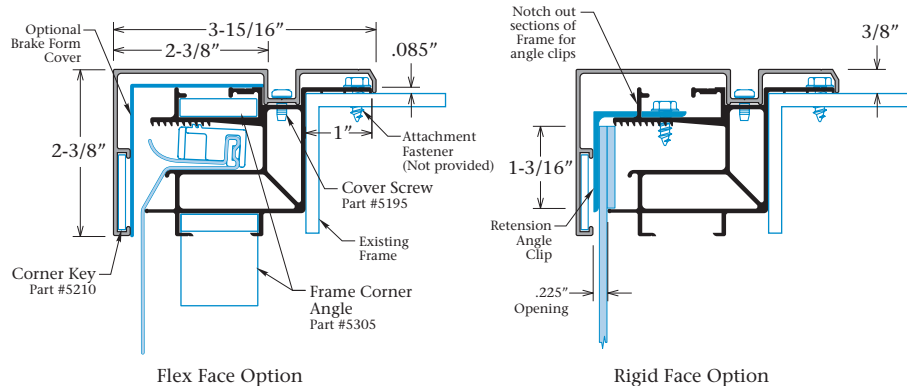

Bleed Retro Frame
Part #2105
Bleed Retro Frame Cover
Part #2122

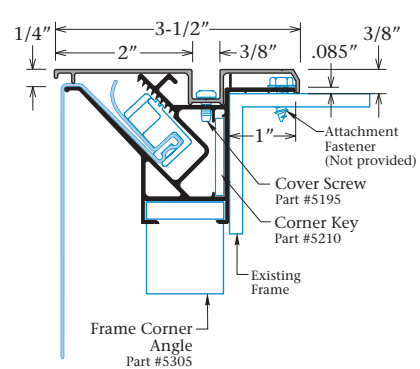

Flat Bleed Retro Frame
Part #2104
Flat Bleed Retro Frame Cover
Part #2121

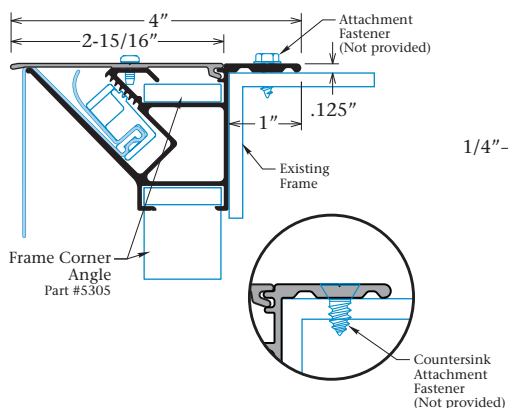

Extended Flat Bleed Retro Frame Cover
Part #2123

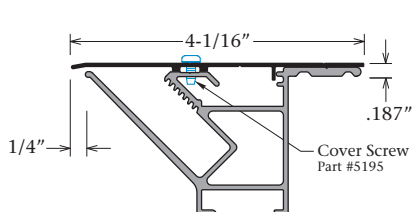

1-1/2" Flat Bleed Retro Frame Cover
Part #2125

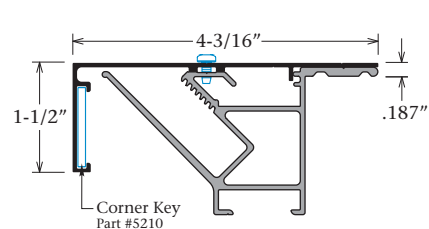

Wall Mount Frame
Part #2100
(For use with Part #2104)

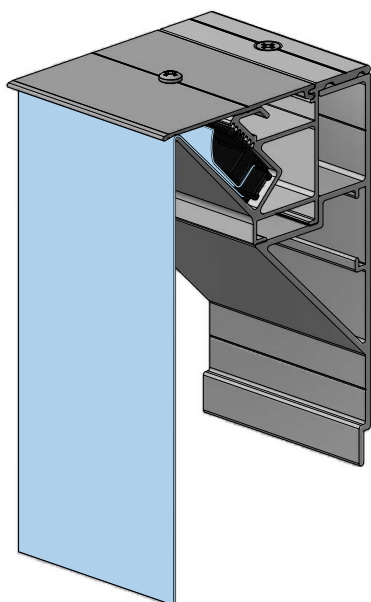
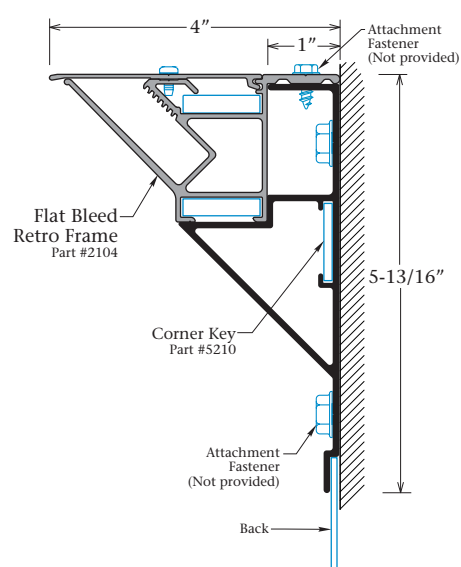

Commercial System Specifications

Retro / Tension Frames and Covers

For Flexible Faces

Flat Bleed Retro Frame II

Part #2107

Flat Bleed Retro Frame Cover

Part #2121

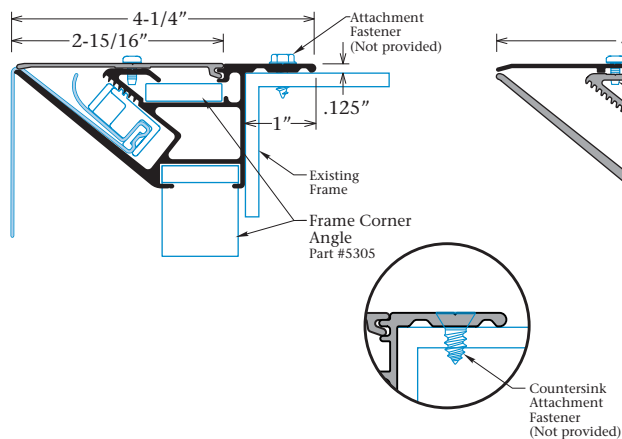

Extended Flat Bleed

Retro Frame Cover II

Part #2124

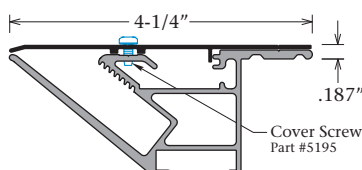

1-1/2" Flat Bleed

Retro Frame Cover II

Part #2127

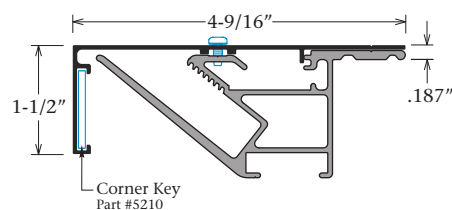

Flat Bleed Retro Frame with Reflector Slot

Part #2103

Flat Bleed Retro Frame Cover

Part #2121

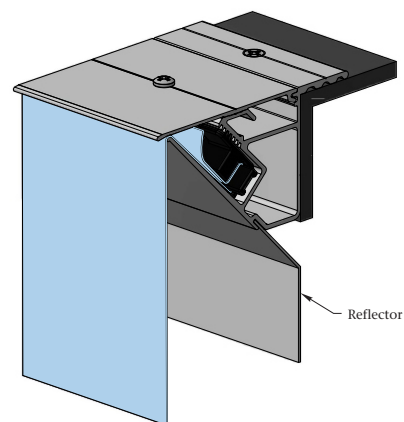
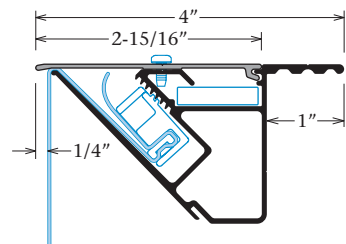

Note: Part #2103 is engineered to integrate with #2121, #2123 and #2125. See page 32

Retro Fascia Frames and Cover

For Flexible Faces

Bleed Fascia Frame

Part #2092

Bleed Fascia Frame Cover

Part #2093

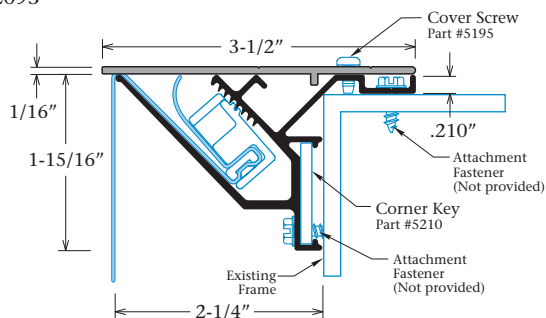

1-1/2" Fascia Frame

Part #2094

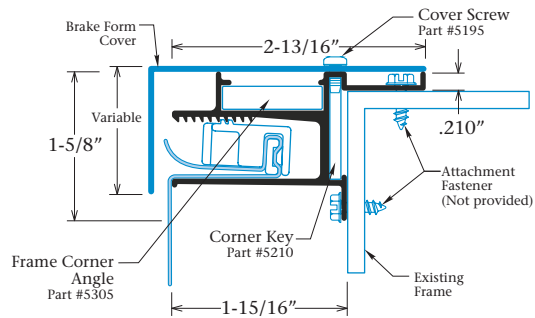

Note: All dimensions are subject to the tolerance standards of the aluminum extrusion industry. Profile drawings are illustrative and rounded to the nearest 1/16".

Commercial System Specifications

Front Load Wall Mount Tension Frame and Cover

For Flexible Faces

Front Load Wall Mount Tension Frame
Part #2080

Front Load Wall Mount Tension Frame Cover
Part #2078

Cover Screw Attachment Options:

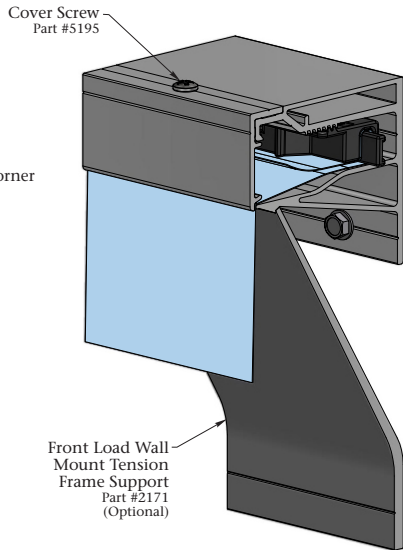
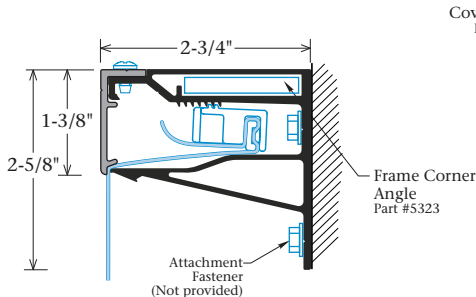

Note: The Front Load Wall Mount Tension Frame requires the Wall Mount Tension Tool, Part #5137.

Wall Mount Tension Frame and Covers

For Flexible Faces

Wall Mount Tension Frame
Part #2090

Wall Mount Tension Frame Radius Cover
Part #2089

Wall Mount Tension Frame Square Cover
Part #2088

Wall Mount Tension Frame Beveled Cover
Part #2091

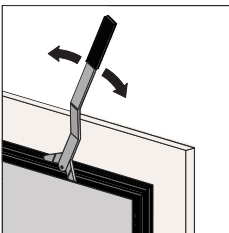
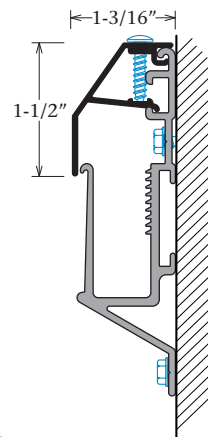
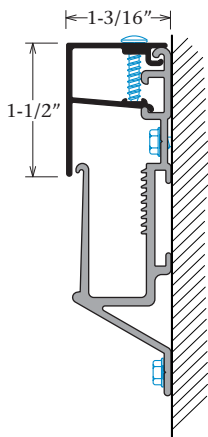
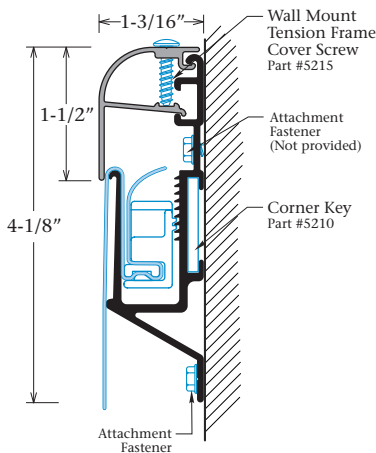

Wall Mount Tension Tool
(Zinc coated)
Part #5137

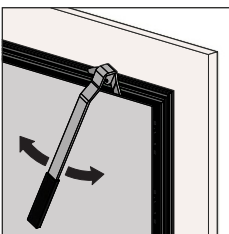
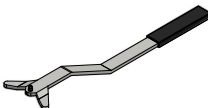

Reverse Wall Mount Tension Tool
(Pre-painted green)
Part #5138

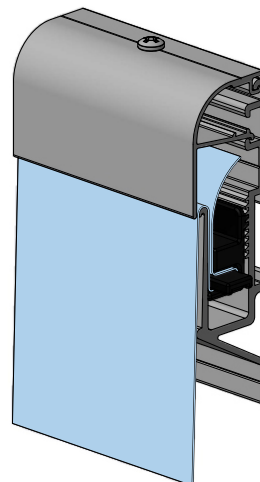
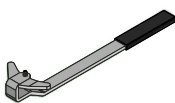

Note: The Wall Mount Tension Frame requires either the Wall Mount Tension Tool, Part #5137 or the Reverse Wall Mount Tension Tool, Part #5138.

Commercial System Specifications

Front Load Soft Signage Systems

For Fabric Faces

1" Front Load Soft Signage Frame

Part #3092

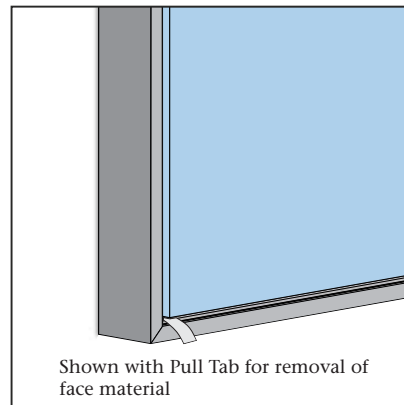
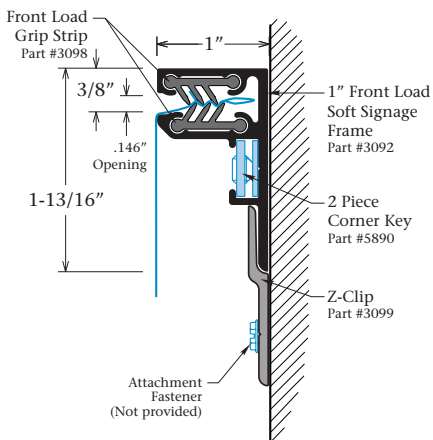

Note: The Pull Tab Screw replaces one (1) of the set screws in the 2 Piece Corner Key.

Front Load Soft Signage Pull Tab Assembly Part #5897

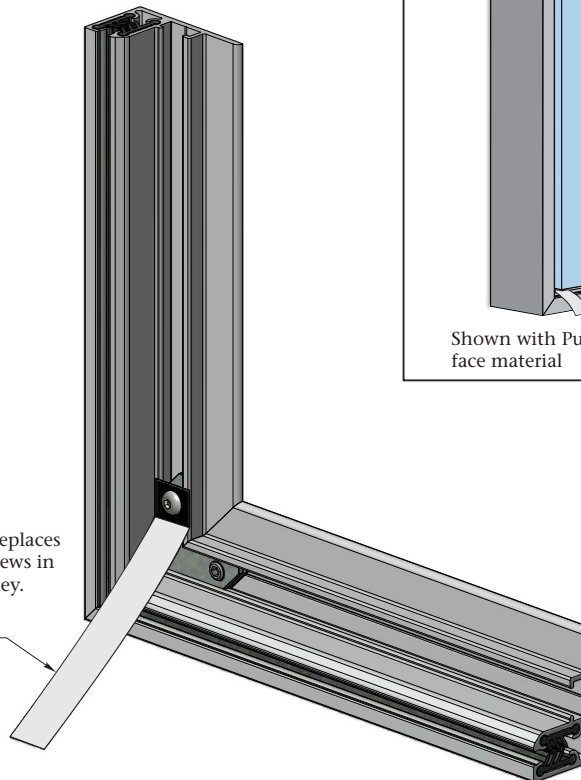

3-1/2" Front Load Soft Signage Frame

Part #3095

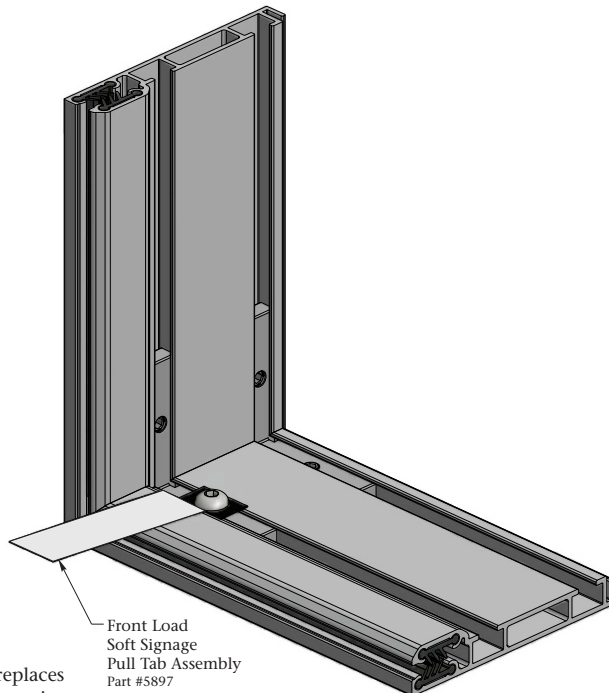
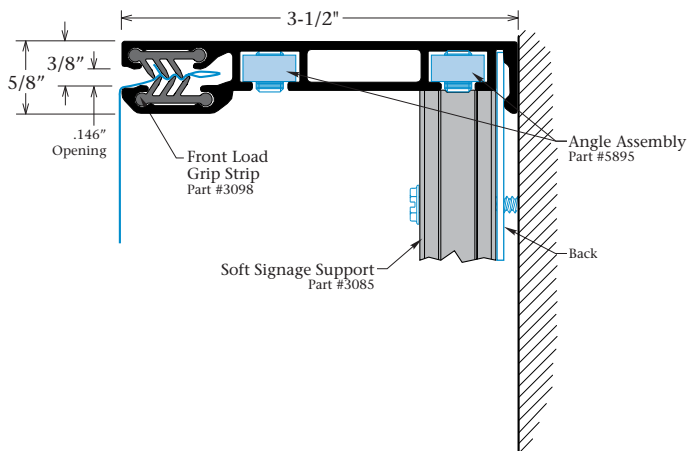

Note: The Pull Tab Screw replaces one (1) of the set screws in the Corner Angle Assembly.

Front Load Soft Signage Pull Tab Assembly Part #5897

Flexible Face Preparation / Extrusion Guidelines

Tension Clip and Flexible Face Requirements

Frame Type (Part # - Name)	Face Trim Size "ADD" to overall Height and Width of the assembled frame.	Clip Line "DEDUCT" from trim size on all (4) four sides.	Clip Placement (on Center)	Tension Tool (Part #)
#2065 - Dual Frame	3"	1-1/2"	6"	5135
#2080 - Front Load Wall Mount Tension Frame	4-1/2"	1-1/2"	6"	5137
#2085 - Tension Frame	6"	1-1/2"	5"	5135
#2086 - Tension Frame II	6-1/2"	1-1/2"	5"	5135
#2090 - Wall Mount Tension Frame	4-1/2"	2-1/4"	5"	5137/5138
#2092 - Bleed Fascia Frame	6"	1-1/2"	5"	5135
#2094 - 1-1/2" Fascia Frame	3"	1-1/2"	6"	5135
#2103 - Flat Bleed Retro Frame w/ Reflector Slot	6-1/2"	1-1/2"	5"	5135
#2104 - Flat Bleed Retro Frame	6-1/2"	1-1/2"	5"	5135
#2105 - Bleed Retro Frame	6"	1-1/2"	5"	5135
#2107 - Flat Bleed Retro Frame II	7"	1-1/2"	5"	5135
#2112 - 2" Retro Frame	3"	1-1/2"	6"	5135
#2142 - Dual Divider	3"	1-1/2"	5"	5135
#2224 - Single Face Tension Body	5"	1-1/2"	5"	5135
#2230 - Flat Bleed Double Face Tension Body	6-1/2"	1-1/2"	5"	5135
#2233 - 6" Flat Bleed Single Face Tension Body	13"	1-1/2"	5"	5135

Complete tensioning instructions are available.

 UL Recognized Component Systems
The Underwriters Laboratory file number is E136850

Extrusion Guidelines

Size of Sign

- Single Face Body Typically limited by the comfort factor for hinging the faces open for service
- Medium Body Typically limited to approximately 64 square feet
- Wide Body Typically limited by the comfort factor for hinging the faces open for service
- 1-1/2" Retainer Typically limited to 32 square feet
- 1-1/2" Retainer II Typically limited to 60 square feet
- Fascia Frames Typically limited to 6' in height - unlimited length

If the size of the sign is such that hinging open for service is not applicable, SignComp offers the following options:

- 1) SignComp retro fit extrusions attached to steel framework - Access panels through fabricated cabinet.
- 2) Service the sign by removing the face -
 - a) Rigid plastic faces - The Dual Frame Cover may be removed to allow the plastic faces to slide to one side.
 - b) Flexible fabric faces - Tension Clips easily release to allow access to the interior of the sign.

Steel Support

- Medium Body Up to a 3" steel support, see page 23
- Wide Body Up to a 6" steel support, see page 23
- Flat 2 Piece Double Face Body Up to a 12" steel support, see page 24
- Flat 2 Piece Double Face Medium Body Up to a 8" steel support, see page 24
- Flat Double Face Body Up to a 6" steel support, see page 24
- Flat Double Face Medium Body Up to a 2" steel support, see page 24

Round, square or rectangular supports may be used. Do not exceed recommended max sizes.

Note: SignComp extrusions are engineered and designed to allow for a wide latitude of designs and applications. The fabrication techniques and material selection are at the sole discretion of the individual fabricator.

Frame Brace and Frame Support Tube Placement

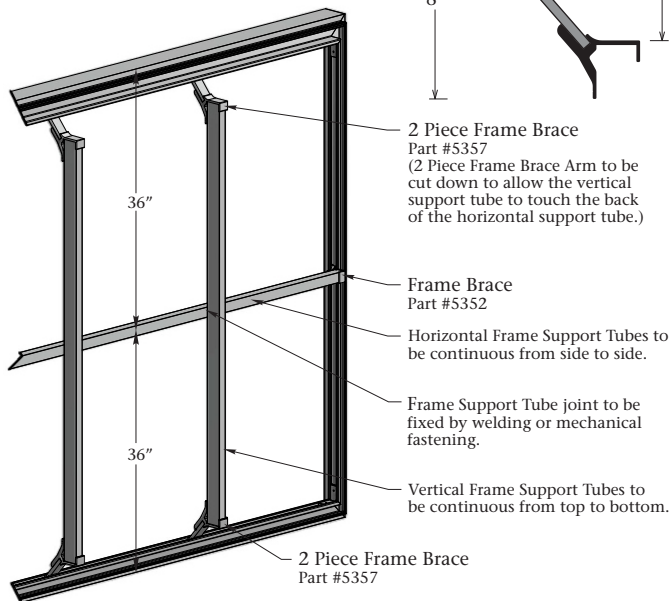
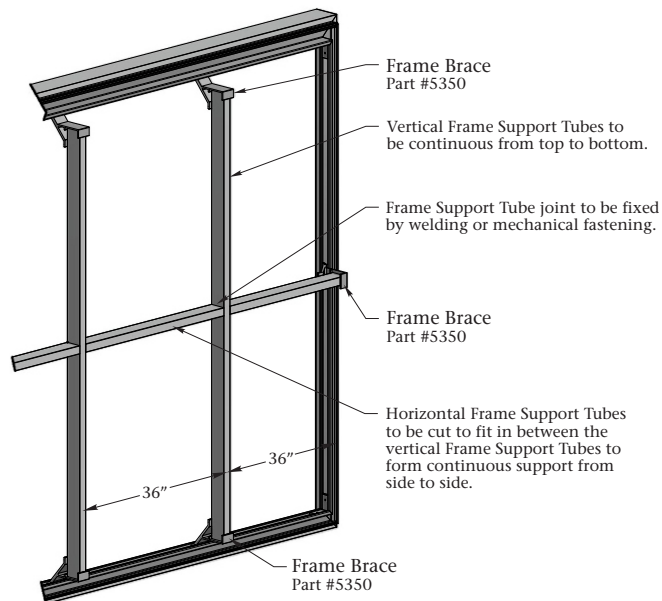
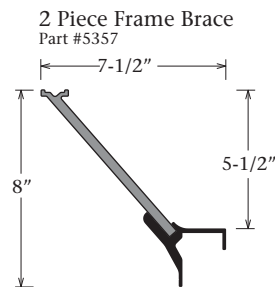
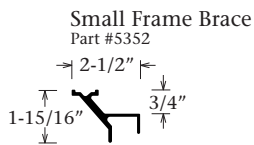
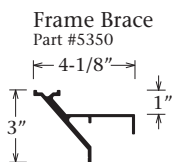

Compression Bracing for Flexible Vinyl Faces

Dual Frame, Tension Frame & Dual Divider

Place a vertical Frame Brace and Frame Support Tube approximately every 36" on center. Cut and insert horizontal pieces of Frame Support Tube approximately every 36" in between the vertical assemblies.

Retro Frames

Applications where the Retro Frame carries the compression load, placement of the Frame Brace and Frame Support Tube is the same as the Dual Frame, Tension Frame and Dual Divider.

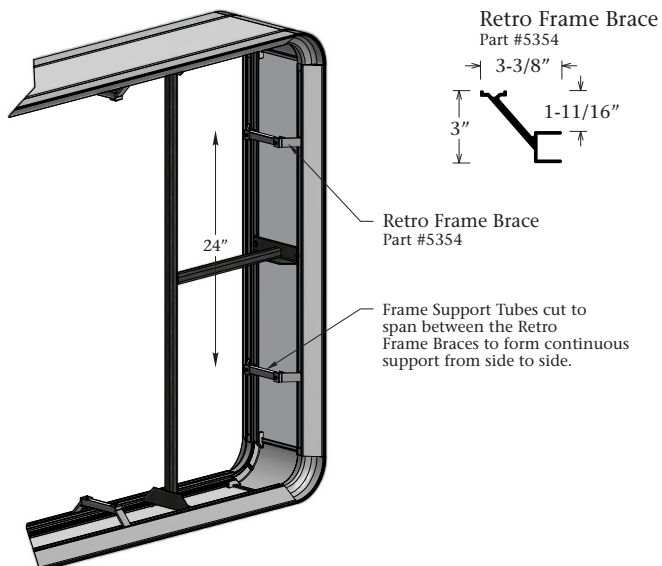

Wind Bracing for Rigid Faces

2-1/4" Retainer & Dual Frame

The Frame Brace and Frame Support Tube may be used to tie the top retainer to the bottom retainer for large hingeable face applications.

1-1/2" Divider

Place a minimum of one (1) vertical Frame Brace and Frame Support Tube in the center of each 10' span.
Note: 10' span for one assembly / 16' span for two assemblies.

2" Divider & 2-3/4" Divider

Place a minimum of one (1) vertical Frame Brace and Frame Support Tube in the center of each 12' span.
Note: 12' span for one assembly / 18' span for two assemblies.

Retro Bracing







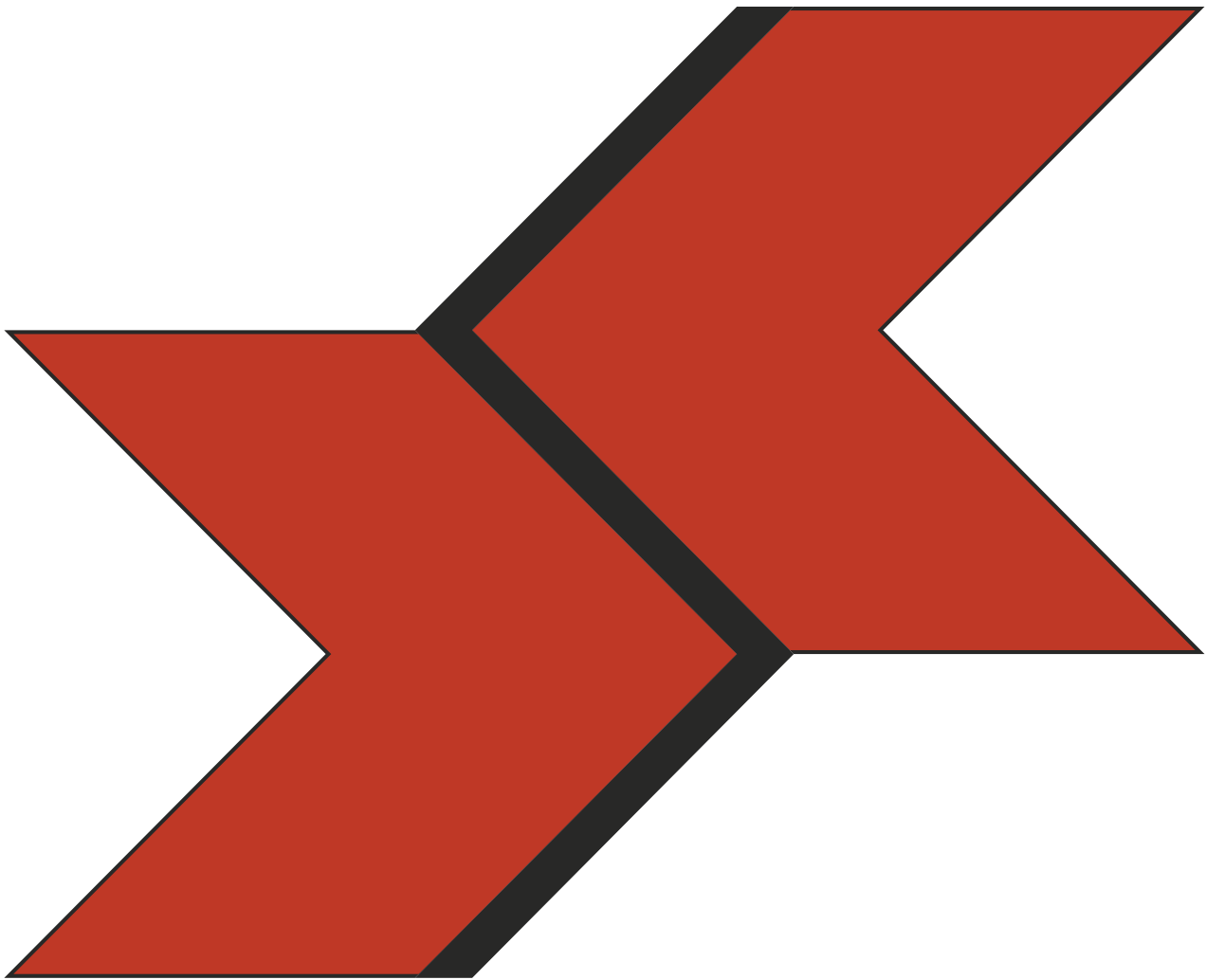





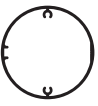







Place a Retro Frame Brace and 1" Frame Support Tube approximately every 24" on center around the perimeter of the cabinet. This bracing option may be used when there IS adequate structure in the cabinet and the frames are NOT required to hinge.

- Medium Body will accept a 3" square steel support tube and Wide Body will accept a 6" steel support, both accommodate the perpendicular placement of Frame Braces and Frame Support Tube
- Do not place the Frame Brace and Frame Support Tube directly in front of parallel steel support structures
- Place all Frame Braces and Frame Support Tubes directly in between parallel lamps
- Frame Braces and Frame Support Tubes that are perpendicular to lamps will not cause shadows
- Frame Brace configuration in cabinets is dependant on the body, frame, support size and lighting source being used

Architectural Products



Extrusions Priced by the Length

	Part	Part Number	Length	Mill Finish	Dk. Bronze
Series 1 Posts					
	Series 1 2" Square Post	1000	24'-0"	\$351.54 <i>Cost per Foot</i> 14.65	N/A N/A
	Series 1 3-1/4" Square Post	1005	24'-0"	382.30 <i>Cost per Foot</i> 15.93	N/A N/A
	Series 1 3-1/4" Round Post	1007	24'-0"	382.30 <i>Cost per Foot</i> 15.93	N/A N/A
Copy Bars and Reveals					
	Series CB Reveal	1410	12'-0"	123.79 <i>Cost per Foot</i> 10.32	N/A N/A
	Series CB 2" x 2" Copy Bar	1420	24'-0"	263.24 <i>Cost per Foot</i> 10.97	N/A N/A
	Series CB 2" x 3" Copy Bar	1430	24'-0"	333.75 <i>Cost per Foot</i> 13.91	N/A N/A
	Series CB 2" x 4" Copy Bar	1440	24'-0"	396.64 <i>Cost per Foot</i> 16.53	N/A N/A
	Series CB 2" x 5" Copy Bar	1450	24'-0"	473.93 <i>Cost per Foot</i> 19.75	N/A N/A
	Series CB 2" x 6" Copy Bar	1460	24'-0"	544.36 <i>Cost per Foot</i> 22.68	N/A N/A
Panel Adaptors					
	Series 2/3/4 1/8" Panel Adaptor	1203 1203P	16'-2"	66.79 <i>Cost per Foot</i> 4.13	96.84 5.99
	Series 2/3/4 1/4" Panel Adaptor	1202 1202P	16'-2"	66.79 <i>Cost per Foot</i> 4.13	96.84 5.99
	Series 2/3/4 1/2" Panel Adaptor	1204 1204P	16'-2"	71.16 <i>Cost per Foot</i> 4.40	103.20 6.38
Reveal and Fillers					
	Series 2/3/4 Reveal	1200 1200P	24'-0"	97.78 <i>Cost per Foot</i> 4.07	141.99 5.92
	Series 3/4 Radius Post Filler	1201	24'-0"	63.17 <i>Cost per Foot</i> 2.63	N/A N/A
	Series 7 Reveal	1550	24'-0"	212.70 <i>Cost per Foot</i> 8.86	N/A N/A
Series 2 Post and Panel System					
	Series 2 2" Square Post	1100 1100P	24'-0"	353.56 <i>Cost per Foot</i> 14.73	450.04 18.75
	Series 2 2" Slide Body	1110 1110P	24'-4"	169.89 <i>Cost per Foot</i> 6.98	220.01 9.04
	Series 2 2" Bleed Body	1120	24'-4"	169.89 <i>Cost per Foot</i> 6.98	N/A N/A
	Series 2 2" Frameless Body	1125	24'-4"	157.16 <i>Cost per Foot</i> 6.46	N/A N/A
	Series 2 2" Beveled Frame	1990 1990P	24'-4"	136.23 <i>Cost per Foot</i> 5.60	195.33 8.03

Extrusions available in full lengths and cut to size kits.

Note: All dimensions are subject to the tolerance standards of the aluminum extrusion industry. Profile drawings are illustrative and rounded to the nearest 1/16".













Extrusions Priced by the Length

Part	Part Number	Length	Mill Finish	Dk. Bronze	
Series 3 Post and Panel System					
	Series 3 3-1/4" Radius Post	1210 1210P	24'-0"	\$420.61 <i>Cost per Foot</i> 17.53	\$511.23 21.30
	Series 3 3-1/4", 1/2 Round End	1212	24'-0"	375.19 <i>Cost per Foot</i> 15.63	N/A N/A
	Series 3 1-5/8", 1/4 Round End	1215	24'-0"	227.35 <i>Cost per Foot</i> 9.47	N/A N/A
	Series 3 3-1/4" Rectangular Post	1220 1220P	24'-0"	420.61 <i>Cost per Foot</i> 17.53	511.23 21.30
	Series 3 3-1/4" Rectangular Post w/ Radius Edges	1230*	24'-0"	420.61 <i>Cost per Foot</i> 17.53	N/A N/A
	Series 3 3-1/4" Triangular Post	1240	24'-0"	420.61 <i>Cost per Foot</i> 17.53	N/A N/A
	Series 3 3-1/4" Triangular Post w/ Radius Edges	1250*	24'-0"	420.61 <i>Cost per Foot</i> 17.53	N/A N/A
	Series 3 3-1/4" Square Post	1233 1233-8'	24'-0" 8'-0"	505.42 <i>Cost per Foot</i> 21.06 168.46 21.06	N/A N/A N/A
	Series 3 3-1/4" Square Post w/ Radius Edges	1235	24'-0"	505.42 <i>Cost per Foot</i> 21.06	N/A N/A
	Series 3 3-1/4" Round Post	1237	24'-0"	505.42 <i>Cost per Foot</i> 21.06	N/A N/A
	Series 3 3-1/4" Slide Body	1260 1260P	24'-4"	228.56 <i>Cost per Foot</i> 9.39	277.80 11.42
	Series 3 3-1/4" Bleed Body	1270	24'-4"	204.58 <i>Cost per Foot</i> 8.41	N/A N/A
	Series 3 3-1/4" Frameless Body	1275	24'-4"	190.62 <i>Cost per Foot</i> 7.83	N/A N/A
	Series 3 3-1/4", 1/4 Round Body	1280	24'-4"	215.84 <i>Cost per Foot</i> 8.87	N/A N/A
	Series 3 1-5/8", 1/2 Slide Body	1265	24'-4"	157.16 <i>Cost per Foot</i> 6.46	N/A N/A

Extrusions available in full lengths and cut to size kits.

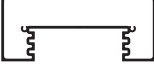
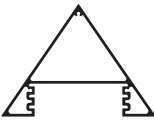
*Available in mill run only

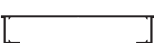
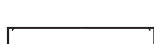
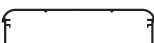
Extrusions Priced by the Length

















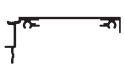



Part	Part Number	Length	Mill Finish
Series 4 Post and Panel System			
 Series 4 4" Square Post	1333	24'-0"	\$590.59 <i>Cost per Foot</i> 24.61
 Series 4 4" Round Post	1337	24'-0"	539.58 <i>Cost per Foot</i> 22.48
 Series 4 4" Round 4-Sided Post	1338	24'-0"	699.87 <i>Cost per Foot</i> 29.16
 Series 4 4" Round 90 Degree Post	1339	24'-0"	587.73 <i>Cost per Foot</i> 24.49
 Series 4 4" Frameless Body	1355	24'-4"	199.49 <i>Cost per Foot</i> 8.20
Series 7 Post and Panel System			
 Series 7 7" Radius Post	1500	24'-0"	824.05 <i>Cost per Foot</i> 34.34
	1500-10'	10'-0"	343.36 <i>Cost per Foot</i> 34.34
 Series 7 7" Rectangular Post	1510	24'-0"	824.05 <i>Cost per Foot</i> 34.34
	1510-10'	10'-0"	343.36 <i>Cost per Foot</i> 34.34
 Series 7 7" Triangular Post	1530	24'-0"	824.05 <i>Cost per Foot</i> 34.34
 Series 7 3-1/2", 1/4 Round End	1670	24'-5"	208.38 <i>Cost per Foot</i> 8.53
 Series 7 7" Slide Body	1560	24'-4"	355.61 <i>Cost per Foot</i> 14.61
 Series 7 7" Bleed Body	1570	24'-4"	296.95 <i>Cost per Foot</i> 12.20
 Series 7 7" Frameless Body	1575	24'-4"	293.44 <i>Cost per Foot</i> 12.06
 Series 7 7", 1/4 Round Body	1580*	24'-4"	337.44 <i>Cost per Foot</i> 13.87
 Series 7 3-1/2", 1/2 Slide Body	1565	24'-4"	251.53 <i>Cost per Foot</i> 10.34

Extrusions available in full lengths and cut to size kits.

*Available in mill run only

Note: All dimensions are subject to the tolerance standards of the aluminum extrusion industry. Profile drawings are illustrative and rounded to the nearest 1/16".

















Extrusions Priced by the Length

	Part	Part Number	Length	Mill Finish
Sign Cabinet Bodies				
	Series 12 Hinge Body	1612	24'-5"	\$639.94 <i>Cost per Foot</i> 26.21
	Series 7 Hinge Body	1592	24'-5"	341.48 <i>Cost per Foot</i> 13.99
	Series 6 Hinge Body	1604	24'-5"	240.12 <i>Cost per Foot</i> 9.83
	Series 6 Single Face Hinge Body	1602	24'-5"	294.53 <i>Cost per Foot</i> 12.06
	Series 4 Single Face Hinge Body	1601	24'-5"	161.06 <i>Cost per Foot</i> 6.60
	Series 4 Access Body	1390	24'-4"	237.05 <i>Cost per Foot</i> 9.74
	Series 4 Single Face Access Body	1391	24'-4"	236.19 <i>Cost per Foot</i> 9.71
	Series 3 Access Body	1290	24'-4"	208.18 <i>Cost per Foot</i> 8.56
	Series 3 Single Face Access Body	1291	24'-4"	188.77 <i>Cost per Foot</i> 7.76
	Retro Body	1600	24'-5"	125.93 <i>Cost per Foot</i> 5.16
Retainers and Covers				
	Slide Retainer	1624	24'-5"	125.42 <i>Cost per Foot</i> 5.14
	3/4" Slide Retainer	1626	24'-5"	125.42 <i>Cost per Foot</i> 5.12
	1/2" Slide Retainer	1627	24'-5"	88.60 <i>Cost per Foot</i> 3.63
	Bleed Retainer	1632	24'-5"	120.31 <i>Cost per Foot</i> 4.93
	Frameless Retainer	1631	24'-5"	120.31 <i>Cost per Foot</i> 4.93
	Access Frame	1690	24'-5"	88.56 <i>Cost per Foot</i> 3.63
	Slide Cover	1694	24'-5"	52.21 <i>Cost per Foot</i> 2.14
	Radius Slide Cover	1695	24'-5"	49.66 <i>Cost per Foot</i> 2.03
	Bleed Cover	1692	24'-5"	73.23 <i>Cost per Foot</i> 3.00
	Frameless Cover	1693	24'-5"	68.94 <i>Cost per Foot</i> 2.82

Extrusions available in full lengths and cut to size kits.

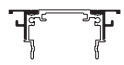
*Available in mill run only

Extrusions Priced by the Length

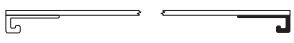
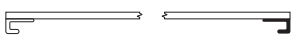





	Part	Part Number	Length	Mill Finish
Retainers	 1/4 Round Retainer	1640	24'-5"	125.42 <i>Cost per Foot</i> 5.14
	 Extended 1/4 Round Retainer	1650	24'-5"	257.52 <i>Cost per Foot</i> 10.55
	 Extended 1/4 Round Retainer w/ Reveal	1655*	24'-5"	387.53 <i>Cost per Foot</i> 15.87
	 Beveled Retainer	1656	24'-5"	353.56 <i>Cost per Foot</i> 14.48
	 Frameless Rigid Retainer	1628	24'-5"	162.07 <i>Cost per Foot</i> 6.64
Divider	 1-1/4" Divider	1662	24'-0"	92.98 <i>Cost per Foot</i> 3.87
Insert Panel Systems Retainers	 Insert Retainer	1666	16'-2"	*104.77 <i>Cost per Foot</i> 6.48
	 Access Frame	1690	24'-5"	88.56 <i>Cost per Foot</i> 3.63
	 Bleed Cover	1692	24'-5"	73.23 <i>Cost per Foot</i> 3.00
	 Frameless Cover	1693	24'-5"	68.94 <i>Cost per Foot</i> 2.82
	 Insert End Cover	1696	24'-5"	43.52 <i>Cost per Foot</i> 1.78
	 Extended Insert End Cover	1698	24'-5"	44.53 <i>Cost per Foot</i> 1.82
	 Insert Top/Bottom Cover	1292	16'-2"	34.52 <i>Cost per Foot</i> 2.14
	Concealed Divider	 Insert Divider	1668	16'-0"
Insert Panels and Adaptors	 4" Aluminum Insert Panel	1674	16'-2"	*118.70 <i>Cost per Foot</i> 7.34
	 6" Aluminum Insert Panel	1676	16'-2"	*165.88 <i>Cost per Foot</i> 10.26
	 8" Aluminum Insert Panel	1678	16'-2"	*278.59 <i>Cost per Foot</i> 17.23
	 Aluminum Insert Adaptor	1679	8'-1"	*21.80 <i>Cost per Foot</i> 2.70
	 Plastic Insert Adaptor For 1/8" Faces	1689	8'-1"	37.70 <i>Cost per Foot</i> 4.66

Extrusions available in full lengths and cut to size kits.

*Clear Anodized
**Black Anodized

Note: All dimensions are subject to the tolerance standards of the aluminum extrusion industry. Profile drawings are illustrative and rounded to the nearest 1/16".



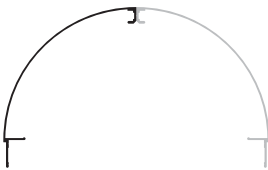

Extrusions Priced by the Length

Part	Part Number	Length	Mill Finish	
Monolithic Edges				
	Sharp Edge 60 Degree	1850	24'-0"	\$573.74 <i>Cost per Foot</i> 23.91
	1-1/2" Radius Edge 60 Degree	1860	24'-0"	567.61 <i>Cost per Foot</i> 23.65
	2-1/2" Radius Edge 60 Degree	1870	24'-0"	614.77 <i>Cost per Foot</i> 25.62
	2" Radius Edge 90 Degree	1880	24'-0"	589.47 <i>Cost per Foot</i> 24.56
	3" Radius Edge 90 Degree	1890	24'-0"	589.47 <i>Cost per Foot</i> 24.56
Radius Ends				
	Series 7 3-1/2", 1/4 Round End	1670	24'-5"	208.38 <i>Cost per Foot</i> 8.53
	6" Radius 1/4 Round End	1671	24'-6"	381.17 <i>Cost per Foot</i> 15.56
	6" Radius 1/4 Round Pole Cover	1672	24'-6"	399.48 <i>Cost per Foot</i> 16.31

Note: Radius Ends require two (2) 1/4 rounds to make one half round.

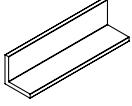

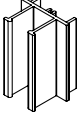
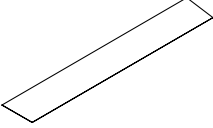
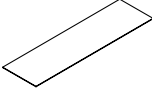









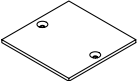
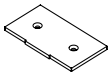

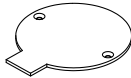



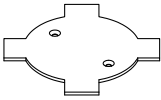
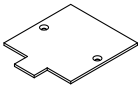

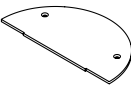

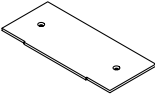

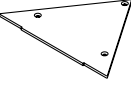

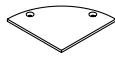
Extrusions available in full lengths only.
Part #1670 and #1671 available in full lengths and kits.

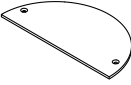
Architectural System Accessories

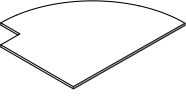

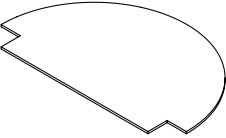

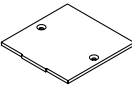
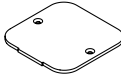















Part	Part Number	Price Each	Part	Part Number	Price Each
Components					
	Series 2 Slide Body Corner Angle 1" x 1" x 1/8" (1-1/8")	5330 \$2.14		Corner Key 3-1/4" x 3-1/4" x .120 Stamped Aluminum	5210 1.55
	Series 2 Bleed/Frameless Body Corner Angle 1" x 1" x 1/8" (1-1/2")	5331 2.14		3/8" Corner Key 2-1/2" x 2-1/2" x .120 Stamped Aluminum (For use with Part #1627)	5212 1.21
	Series 3 Slide Body Corner Angle 1" x 1" x 1/8" (2-1/4")	5335 2.45		3/4" Corner Key 3-1/16" x 3-1/16" x .125 Stamped Aluminum (For use with Part #1626 and #1695)	5226 1.48
	Series 3 Bleed/Frameless Body Corner Angle 1" x 1" x 1/8" (2-11/16")	5337 2.45		2" Series CB Reveal Cut to size and notched	1412 7.44
	Series 3 Single Face Access Body Corner Angle 2" x 2" x 1/8" (1-1/2")	5338 2.54		3" Series CB Reveal Cut to size and notched	1413 7.97
	Series 3 Access Body Corner Angle 2" x 2" x 1/8" (1-5/16")	5339 2.54		4" Series CB Reveal Cut to size and notched	1414 8.45
	Series 4 Single Face Access Body / Access Body Corner Angle 2" x 2" x 1/8" (2")	5340 4.43		5" Series CB Reveal Cut to size and notched	1415 9.05
	Series 4 Frameless Body Corner Angle 1" x 1" x 1/8" (3-9/16")	5341 4.43		6" Series CB Reveal Cut to size and notched	1416 9.49
	Series 7 Slide Body Corner Angle 2" x 2" x 1/8" (5-3/4")	5348 8.07		Series 7 Hinge Body / Series 7 Single Face Hinge Body Raceway Cover 4-3/8" x 48" x .040" (white) Blank	5122 12.21
	Series 4 Single Face Hinge Body Corner Angle 1-3/4" x 1-3/4" x 1/4" (2-1/8")	5345 3.39		Series 12 Hinge Body Raceway Cover 9-1/8" x 48" x .040" (white) Blank	5124 30.50
	Series 6 Single Face Hinge Body Corner Angle 1-3/4" x 1-3/4" x 1/4" (4-1/8")	5346 5.13		Series 7 Hinge Body Ballast Bracket 3-3/4" x 24" x .080"	5102 15.28
	Series 6 Hinge Body Corner Angle 1-3/4" x 1-3/4" x 1/4" (2-11/16")	5343 3.75		Series 7 Single Face Hinge Body Ballast Bracket 4-1/8" x 24" x .080"	5104 15.28
	Series 7 Hinge Body Corner Angle 1-3/4" x 1-3/4" x 1/4" (3-13/16")	5344 4.61		Series 12 Hinge Body Ballast Bracket 8-11/16" x 24" x .080"	5107 15.28
	Series 12 Hinge Body Corner Angle 1-3/4" x 1-3/4" x 1/4" (8-3/4")	5342 10.07		Insert Divider Tab 3/4" x 2" x .125"	5306 1.25
	Extended 1/4 Round Retainer / Extended 1/4 Round Retainer w/Reveal Corner Angle 1" x 1" x 1/8" (1/2")	5325 1.83		1-1/4" Divider Tab 1" x 2-1/4" x .125"	5308 1.25

Note: All dimensions are subject to the tolerance standards of the aluminum extrusion industry. Profile drawings are illustrative and rounded to the nearest 1/16".

Architectural System Accessories







Part	Reveal Tab	Part Number	Price Each	Part	Reveal Tab	Part Number	Price Each
Series 1 Post Caps				Series 3 Pre-painted Post Caps			
 2" Square	N/A	5250	\$6.08	 Radius	0" 3/8" 3/4"	5000P 5002P 5004P	\$8.77 8.77 8.77
 3-1/4" Square	N/A	5252	6.08	 Rectangular	0" 3/8" 3/4"	5010P 5012P 5014P	8.77 8.77 8.77
 3-1/4" Round	N/A	5254		Series 4 Post Caps			
Series 2 Post Caps				 Round	3/4"	5430	12.99
 Square	0" 3/8" 3/4"	5260 5261 5262	6.08 6.08 6.08	 90 Degree Round	3/4"	5431	12.99
 Beveled	N/A	5460	8.52	 4-Sided Round	3/4"	5432	12.99
Series 2 Pre-painted Post Caps				 Square	3/4"	5433	12.99
 Square	0" 3/8" 3/4"	5260P 5261P 5262P	8.77 8.77 8.77	Series 7 Post Caps			
Series 3 Post Caps				 Radius	0" 1/2" 1"	5020 5024 5026	12.21 12.21 12.21
 Radius	0" 3/8" 3/4"	5000 5002 5004	6.08 6.08 6.08	 Rectangular	0" 1/2" 1"	5030 5034 5036	12.21 12.21 12.21
 1/2 Round Post	N/A	5005	6.08	 Triangular	0" 1/2" 1"	5425 5426 5427	12.21 12.21 12.21
 1/4 Round Post End R	N/A	5003R	4.11	 3-1/2" Radius End	N/A	5028	8.19
 1/4 Round Post End L	N/A	5003L	4.11	 1/2 Round End	N/A	5029	15.65
 Rectangular	0" 3/8" 3/4"	5010 5012 5014	6.08 6.08 6.08	6" Radius End Caps			
 Rectangular w/ Radius Edges	0" 3/8" 3/4"	5006 5007 5008	6.08 6.08 6.08	 6" Radius End 1/4 Round	1-1/4"	5441	15.30
 Triangular	0" 3/8" 3/4"	5015 5016 5017	6.08 6.08 6.08	 6" Radius End	1-1/4"	5440	29.47
 Triangular w/ Radius Edges	0" 3/8" 3/4"	5400 5401 5402	6.08 6.08 6.08	Note: All post caps are .125 stamped aluminum, pre-drilled and countersunk. The 6" Radius End Cap is not pre-drilled. All caps are slightly oversized.			
 Square	0" 3/8" 3/4"	5405 5406 5407	6.08 6.08 6.08				
 Square w/ Radius Edges	0" 3/8" 3/4"	5410 5411 5412	6.08 6.08 6.08				
 Round	0" 3/8" 3/4"	5415 5416 5417	6.08 6.08 6.08				

Architectural System Accessories

Part	Part Number	Price Each
Hardware		
  Cap Screw #10 x 1/2" stainless steel square/phillips drive countersink screw - Type A	5040 5040P	\$19.00/100 29.00/100
  Copy Bar Screw Pre-drill and countersink 1/8" holes two (2) per end Access Frame Cover Screw Pre-drill and countersink 1/8" holes 12" o/c Divider Tab Screw Pre-drill 1/8" holes two (2) per Divider #8 x 1/2" stainless steel square/phillips drive countersink screw - Type A	5168	14.00/100
  Reveal to Body Screw Pre-drill 5/32" holes 12" o/c Corner Angle Screw Pre-drill 5/32" holes four (4) per body corner Panel Adaptor Attachment Screw Pre-drill 5/32" holes 6" o/c #10 x 1/2" stainless steel square/phillips drive pan head tapping screw w/ wax - Type AB	5218	38.00/100
  Closure Screw Pre-drill and countersink 5/32" holes along bottom and sides of retainer 36" o/c #10 - 24 x 7/8" stainless steel square/phillips drive countersink machine screw	5230	29.00/100
  Slide Body Corner Screw Pre-drill and countersink 5/32" holes two (2) per corner on horizontals #10 - 24 x 3/4" stainless steel square/phillips drive countersink thread cutting screw - Type F	5240 5240P	29.00/100 40.00/100
  Series 3,1/2 Slide Body Corner Screw Pre-drill and countersink 1/8" holes two (2) per corner on horizontals 2" Beveled Frame Corner Screw Pre-drill and countersink 1/8" holes two (2) per corner on horizontals #8 x 3/4" stainless steel square/phillips drive countersink screw - Type A	5241	12.00/100
  Slide/Insert Retainer Corner Screw Pre-drill and countersink 1/8" holes two (2) per corner on horizontals Access Frame Corner Screw Pre-drill and countersink 1/8" holes two (2) per corner Access Body Corner Screw Pre-drill and countersink 1/8" holes two (2) per corner on horizontals #8 x 1-1/2" stainless steel square/phillips drive countersink screw - Type A	5270	29.00/100
  Hinge Screw Pre-drill 5/16" holes through the retainer along top 18" o/c #10 - 24 x 5/8" stainless steel allen head machine screw	5280	37.00/100
  Rigid Retainer Hardware Pre-drill and countersink 9/32" holes along all sides 18" o/c 1/4"-20 x 1" stainless steel square drive countersink machine screw/bushing/lock nut	5285	1.29/ea
  Raceway Cover Screw Pre-drill 1/8" holes 24" o/c #8 x 1/2" steel zinc square/phillips drive pan head screw - Type A	5290	16.00/100

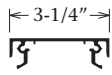
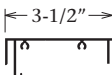
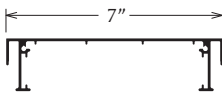
Note: All dimensions are subject to the tolerance standards of the aluminum extrusion industry. Profile drawings are illustrative and rounded to the nearest 1/16".

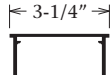
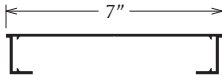
Architectural System Configurations

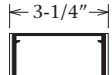
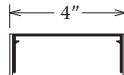
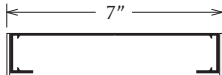
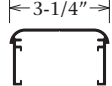
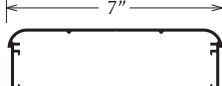
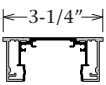
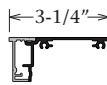
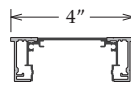
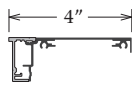
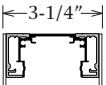
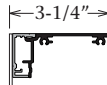
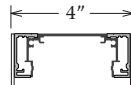
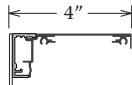
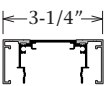
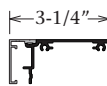
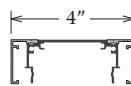
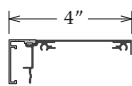
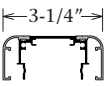
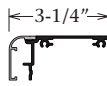
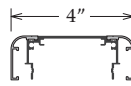
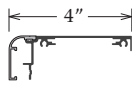
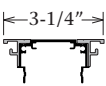
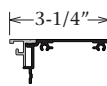
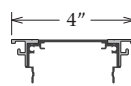
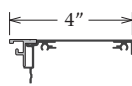
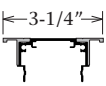
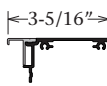
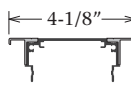
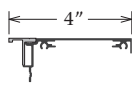
	Series 2	Single Face Series 3	Series 3	Series 4	Single Face Series 7	Series 7
Framed Face Bodies						
Slide Body #1110, #1265, #1260, #1565, #1560	 2"	 1-5/8"	 3-1/4"		 3-1/2"	 7"
Flush Face Bodies						
Bleed Body #1120, #1270, #1570	 2"		 3-1/4"			 7"
Frameless Body #1125, #1275, #1355, #1575	 2"		 3-1/4"	 4"		 7"
Radius Edge Bodies						
1/4 Round Body #1280 and #1580*			 3-1/4"			 7"
		Series 3 Access Body #1290	Series 3 Single Face Access Body #1291	Series 4 Access Body #1390	Series 4 Single Face Access Body #1391	
Non-Hingeable Retainers						
Flush Face Retainers						
Bleed Cover #1692		 3-1/4"	 3-1/4"	 4"	 4"	
Frameless Cover #1693		 3-1/4"	 3-1/4"	 4"	 4"	
Framed Face Retainers						
Slide Cover #1694		 3-1/4"	 3-1/4"	 4"	 4"	
Radius Slide Cover #1695		 3-1/4"	 3-1/4"	 4"	 4"	
Insert Panel Retainers						
Insert Cover #1292		 3-1/4"	 3-1/4"	 4"	 4"	
Insert End Cover #1696		 3-1/4"	 3-5/16"	 4-1/8"	 4"	
Extended Insert End Cover #1698						

*Available in mill run only

Architectural System Configurations

Framed Face Retainers

Slide Retainer

#1624

Series 12 Hinge Body
#1612

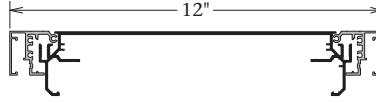

Series 7 Hinge Body
#1592

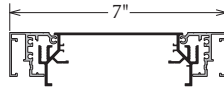

Series 7 Single Face Hinge Body
#1602

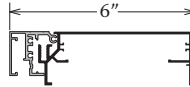

Series 7/12 Retro Body
#1600



3/4" Slide Retainer

#1626

Series 12 Hinge Body
#1612

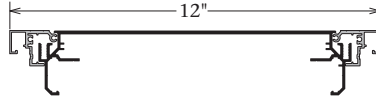

Series 7 Hinge Body
#1592

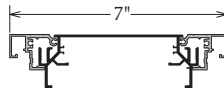

Series 7 Single Face Hinge Body
#1602

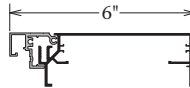

Series 7/12 Retro Body
#1600



Framed Face Retainers

Access Frame with Slide Cover

#1690 and #1694

Series 12 Hinge Body
#1612

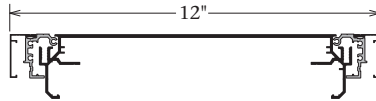

Series 7 Hinge Body
#1592

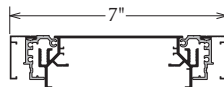

Series 7 Single Face Hinge Body
#1602

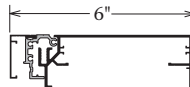

Series 7/12 Retro Body
#1600



Note: All dimensions are subject to the tolerance standards of the aluminum extrusion industry. Profile drawings are illustrative and rounded to the nearest 1/16".

Architectural System Configurations

Framed Face Retainers

Access Frame with Radius Slide Cover

#1690 and #1695

Series 12 Hinge Body
#1612

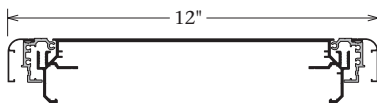

Series 7 Hinge Body
#1592

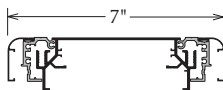

Series 7 Single Face Hinge Body
#1602

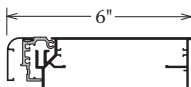

Series 7/12 Retro Body
#1600



Flush Face Retainers

Bleed Retainer

#1632

Series 12 Hinge Body
#1612

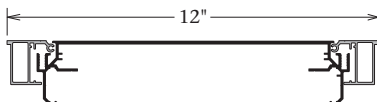

Series 7 Hinge Body
#1592

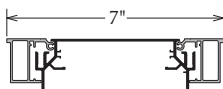

Series 7 Single Face Hinge Body
#1602

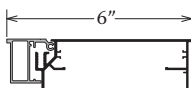

Series 7/12 Retro Body
#1600



Frameless Retainer

#1631

Series 12 Hinge Body
#1612

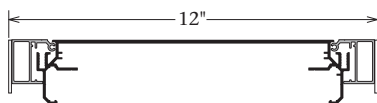

Series 7 Hinge Body
#1592

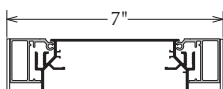

Series 7 Single Face Hinge Body
#1602

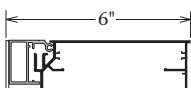

Series 7/12 Retro Body
#1600



Architectural System Configurations

Flush Face Retainers

Access Frame with Bleed Cover #1690 and #1692

Series 12 Hinge Body
#1612

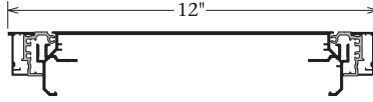

Series 7 Hinge Body
#1592

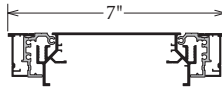

Series 7 Single Face Hinge Body
#1602

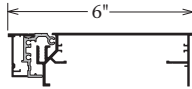

Series 7/12 Retro Body
#1600



Access Frame with Frameless Cover #1690 and #1693

Series 12 Hinge Body
#1612

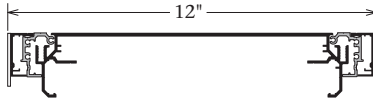

Series 7 Hinge Body
#1592

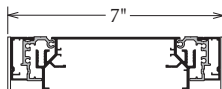

Series 7 Single Face Hinge Body
#1602

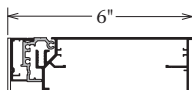

Series 7/12 Retro Body
#1600



Note: All dimensions are subject to the tolerance standards of the aluminum extrusion industry. Profile drawings are illustrative and rounded to the nearest 1/16".

Architectural System Configurations

Radius Edge Retainers

1/4 Round Retainer

#1640

Series 12 Hinge Body
#1612

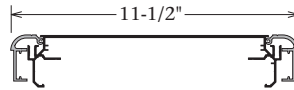

Series 7 Hinge Body
#1592

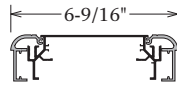

Series 7 Single Face Hinge Body
#1602

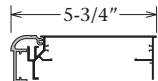

Series 7/12 Retro Body
#1600

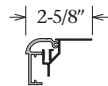

Extended 1/4 Round Retainer

#1650

Series 12 Hinge Body
#1612

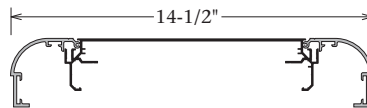

Series 7 Hinge Body
#1592

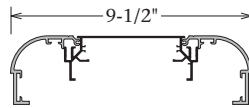

Series 7 Single Face Hinge Body
#1602

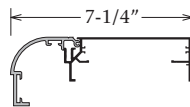

Series 7/12 Retro Body
#1600

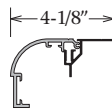

Extended 1/4 Round Retainer with Reveal

#1655*

Series 12 Hinge Body
#1612

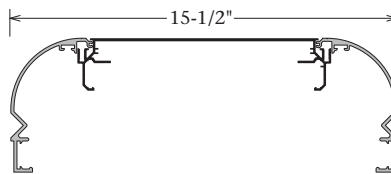

Series 7 Hinge Body
#1592

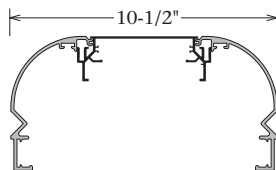

Series 7 Single Face Hinge Body
#1602

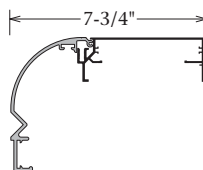

Series 7/12 Retro Body
#1600

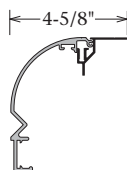

*Available in mill run only

Architectural System Configurations

Beveled Edge Retainer

Beveled Retainer
#1656

Series 12 Hinge Body
#1612

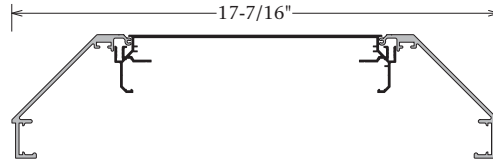

Series 7 Hinge Body
#1592

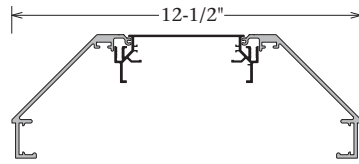

Series 7 Single Face Hinge Body
#1602

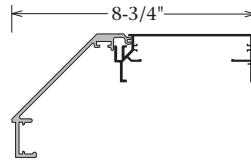

Series 7/12 Retro Body
#1600

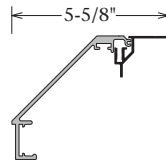

Bleed Pan Face Retainer

Frameless Rigid Retainer
#1628

Series 12 Hinge Body
#1612

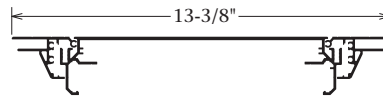

Series 7 Hinge Body
#1592

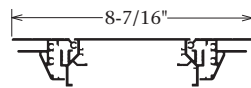

Series 7 Single Face Hinge Body
#1602

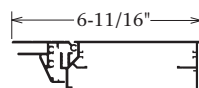

Series 7/12 Retro Body
#1600

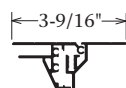

Note: All dimensions are subject to the tolerance standards of the aluminum extrusion industry. Profile drawings are illustrative and rounded to the nearest 1/16".

Architectural System Configurations

Insert Panel Retainers

Insert Retainer

#1666

Series 12 Hinge Body

#1612

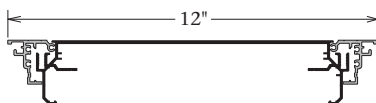

Series 7 Hinge Body

#1592

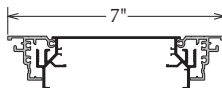

Series 7 Single Face Hinge Body

#1602

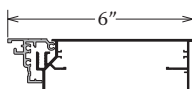

Series 7/12 Retro Body

#1600



Access Frame with Insert End Cover or optional Extended Insert End Cover

#1690 and #1696 or #1698

Series 12 Hinge Body

#1612

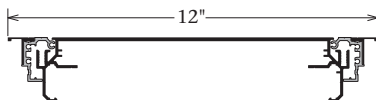

Series 7 Hinge Body

#1592

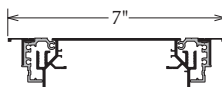

Series 7 Single Face Hinge Body

#1602

(Shown with Part #1698)

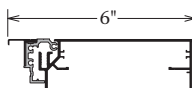

Series 7/12 Retro Body

#1600

(Shown with Part #1698)



Architectural System Specifications

Series 1

Post and Panel Systems for 1/8" Faces

3 Posts

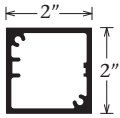

2" Square Post
Part #1000

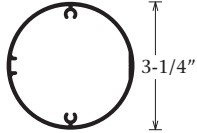

3-1/4" Round Post
Part #1007

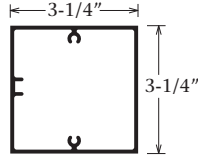

3-1/4" Square Post
Part #1005

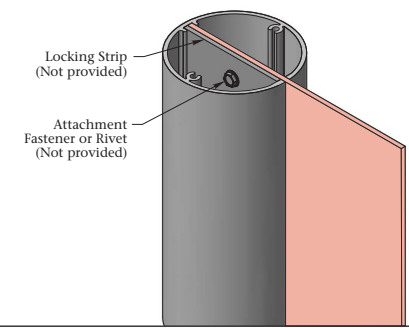
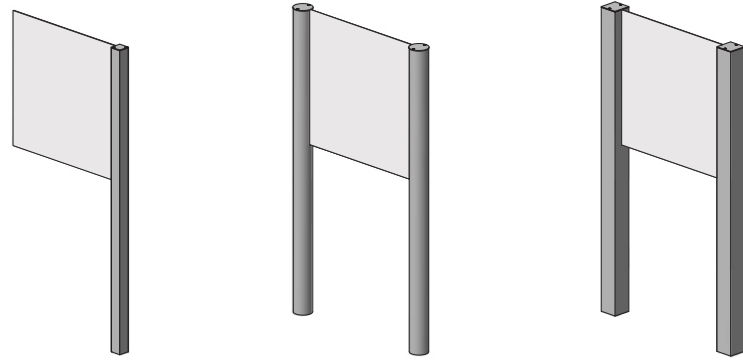
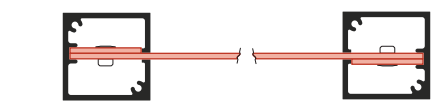
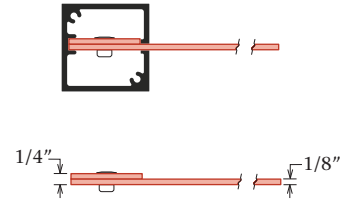

ARCHITECTURAL

Copy Bar

2" Copy Bar Systems

5 Copy Bars



2" x 2"
Copy Bar
Part #1420



2" x 3"
Copy Bar
Part #1430



2" x 4"
Copy Bar
Part #1440



2" x 5"
Copy Bar
Part #1450



2" x 6"
Copy Bar
Part #1460

1 Reveal

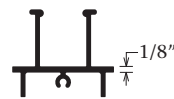

CB Reveal
Part #1410

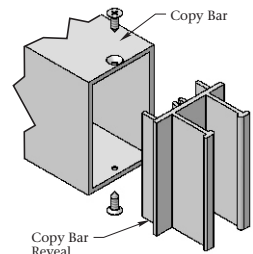
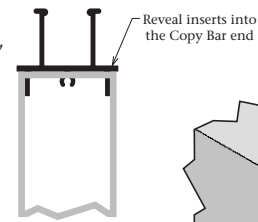

- One Reveal Shape:
- Fits into all five (5) Copy Bars
 - Slides into Series 2, 3 & 4 posts
 - Delivers three (3) reveal positions

Copy Bar

2" Header Panel

2 Bodies



Bleed Body
Part #1120

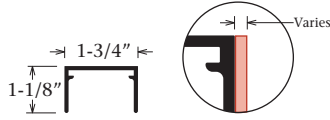

Frameless Body
Part #1125

1 Reveal



Reveal
Part #1200



- One Reveal Shape:
- Easily attaches to the body
 - Slides into Series 2, 3 & 4 posts
 - Delivers three (3) reveal positions
 - Fills the post below the panel

All post options offer three (3) reveal positions: 0", 3/8" & 3/4"

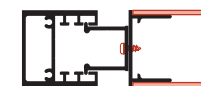

Architectural System Specifications

Copy Bar (cont.)

Posts

Note: See pages 58-60 for additional information on posts.

13 Posts

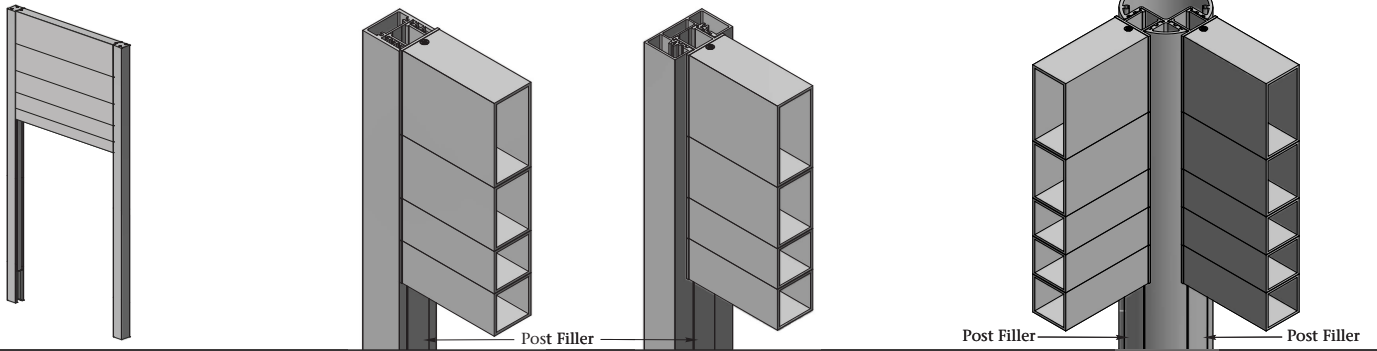
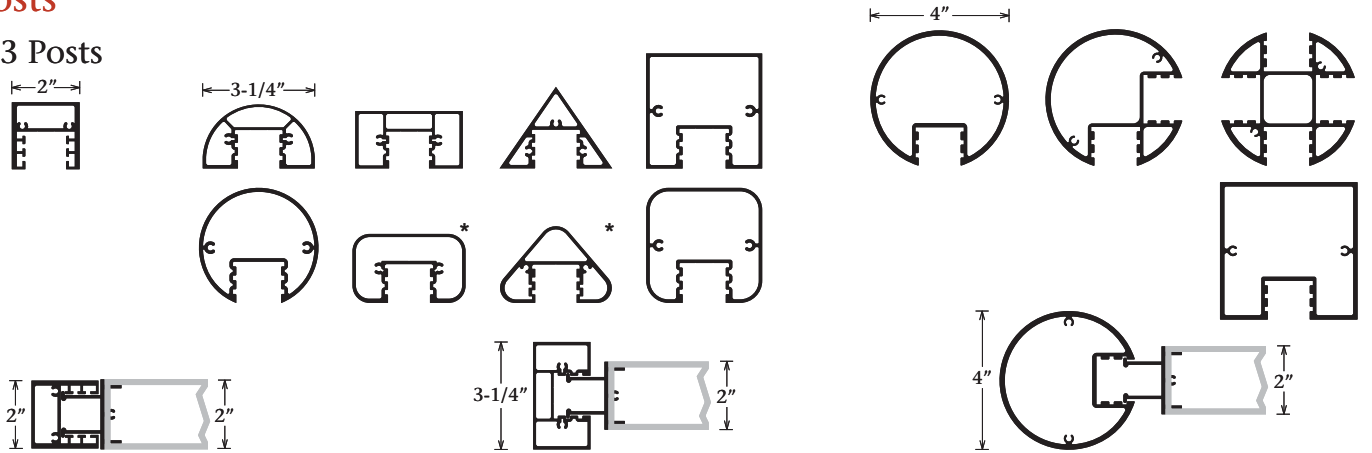

Series 2

2" Post & Panel Systems

3 Bodies

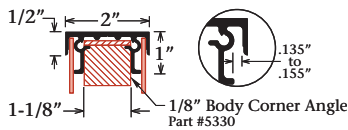

Slide Body
Part #1110
For Removable Faces

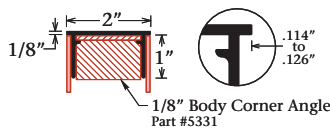
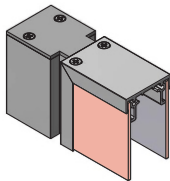

Bleed Body
Part #1120
For Fixed Faces

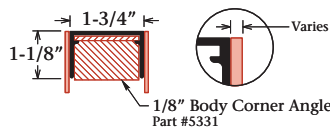
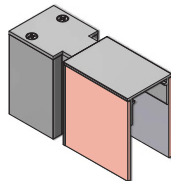

Frameless Body
Part #1125
For Fixed Flush Faces

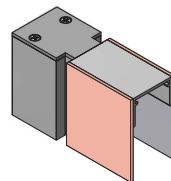

1 Frame

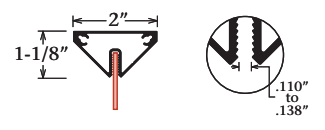

2" Beveled Frame
Part #1990
For Removable Faces

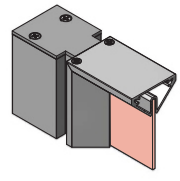

1 Reveal

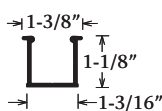

Reveal
Part #1200

- One Reveal Shape:
- Easily attaches to all bodies
 - Slides into Series 2, 3 & 4 posts
 - Delivers 3 reveal positions
 - Fills the post below the panel

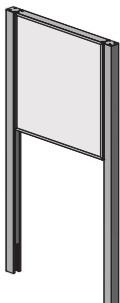

1 Post

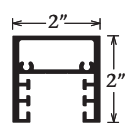

2" Square Post
Part #1100

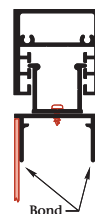

Three Reveal Positions
0", 3/8" & 3/4"

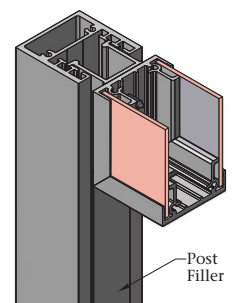

*Available in mill run only

Architectural System Specifications

ARCHITECTURAL

Series 3 3-1/4" Post & Panel Systems

5 Bodies



Slide Body
Part #1260
For Removable Faces

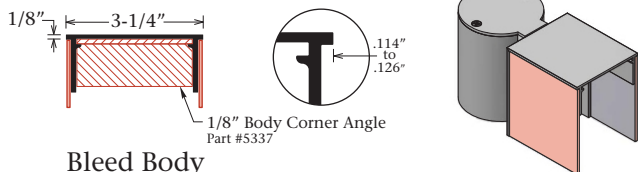

Bleed Body
Part #1270
For Fixed Faces

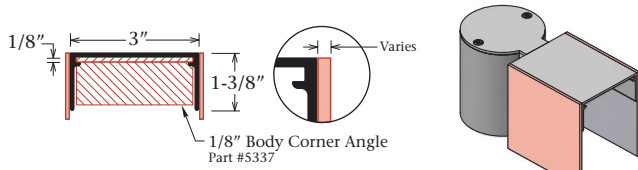

Frameless Body
Part #1275
For Fixed Flush Faces

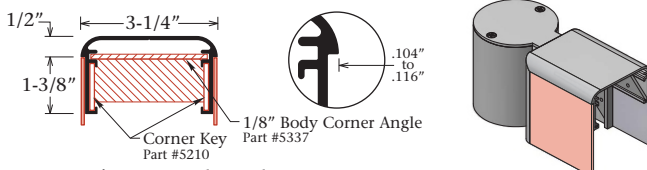

1/4 Round Body
Part #1280
For Fixed Faces

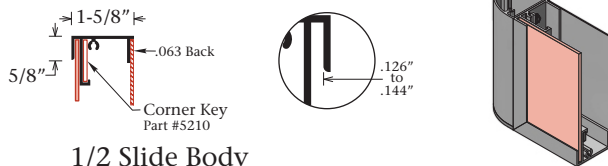

1/2 Slide Body
Part #1265
For Removable Faces

2 Radius Ends

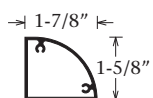

1/4 Round End
Part #1215

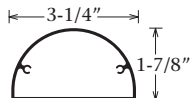

1/2 Round End
Part #1212



Top view of Series 3
1/4 Round End
on 1/2 Slide Body

8 Posts

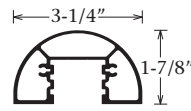

Radius Post
Part #1210

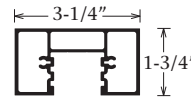

Rectangular Post
Part #1220

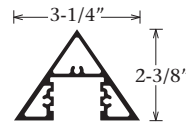

Triangular Post
Part #1240

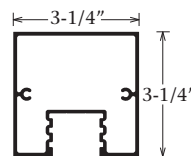

Square Post
Part #1233

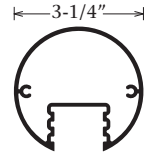

Round Post
Part #1237

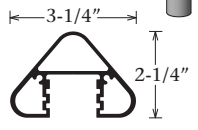
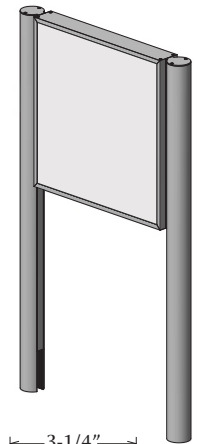

Triangular Post w/Radius Edges
*Part #1250

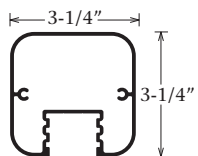

Square Post w/Radius Edges
Part #1235

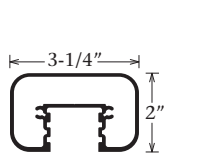

Rectangular Post w/Radius Edges
*Part #1230

1 Reveal

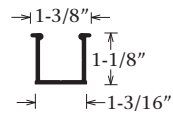

Reveal
Part #1200

1 Post Filler

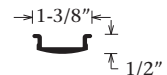

Series 3/4 Radius Post Filler
Part #1201

- One Reveal Shape:
- Easily attaches to all bodies
 - Slides into Series 2, 3 & 4 posts
 - Fills the post below the panel

Note: Designed to integrate with the Series 3 and Series 4 Round Posts.

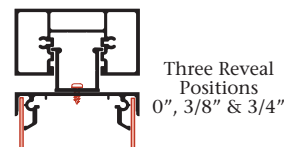

Three Reveal Positions
0", 3/8" & 3/4"

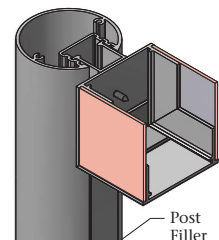

*Available in mill run only

Note: All dimensions are subject to the tolerance standards of the aluminum extrusion industry. Profile drawings are illustrative and rounded to the nearest 1/16".

Architectural System Specifications

Series 4 4" Post & Panel Systems

1 Body

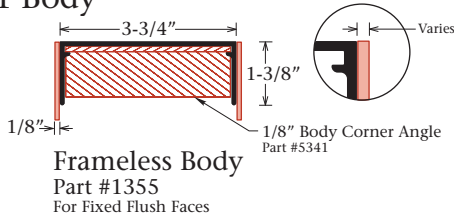

4 Posts

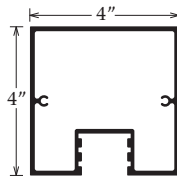

4" Square Post
Part #1333

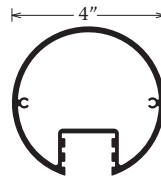

4" Round Post
Part #1337

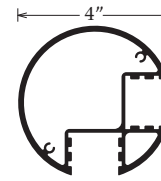

4" Round
90 Degree Post
Part #1339

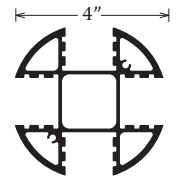

4" Round
4 Sided Post
Part #1338

1 Reveal

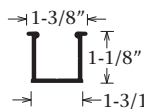

Reveal
Part #1200

- One Reveal Shape:
- Easily attaches to all bodies
 - Slides into Series 2, 3 & 4 posts
 - Delivers 3 reveal positions

1 Post Filler

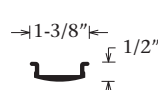

Series 3/4
Radius Post Filler
Part #1201

- One Post Filler:
Designed to integrate with the Series 3 and Series 4 Round Posts

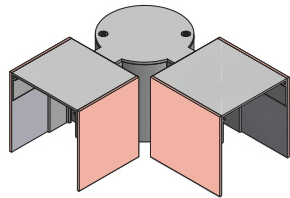
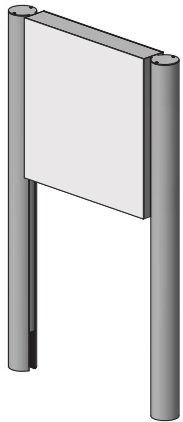
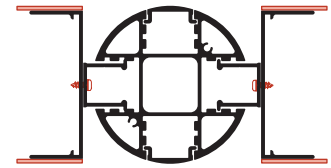

Frameless Body
Part #1355
4" Round 90 Degree Post
Part #1339

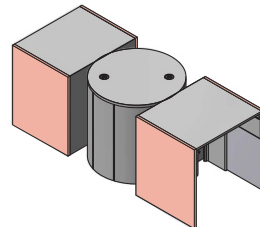

Frameless Body
Part #1355
4" Round Four Sided Post
Part #1338

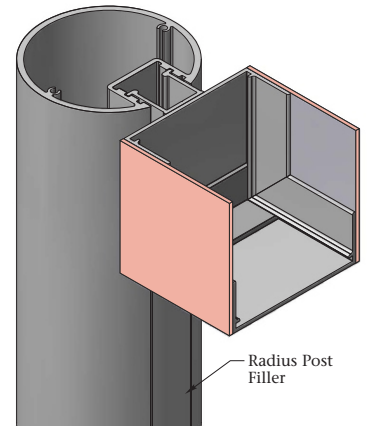

Series 2, 3, 4 Panel Adaptor Systems

3 Panel Adaptors

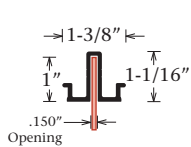

1/8" Panel Adaptor
Part #1203

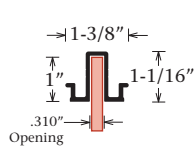
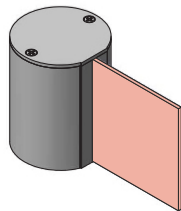

1/4" Panel Adaptor
Part #1202

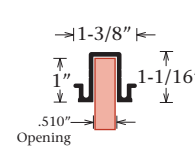
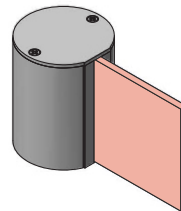

1/2" Panel Adaptor
Part #1204

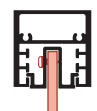
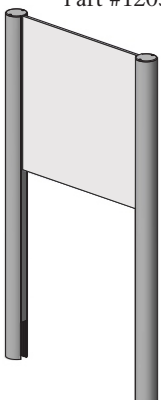
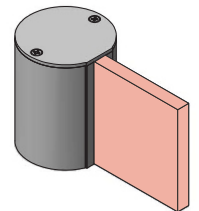

One Reveal Position
0"

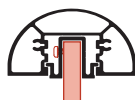

One Reveal Position
0"

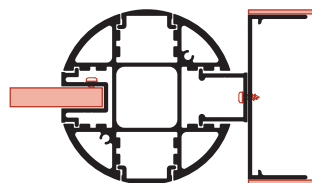

One Reveal Position
0"

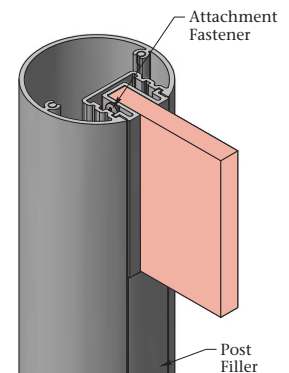

Note: See pages 58-60 for post options and additional information.

Architectural System Specifications

Series 7 7" Post and Panel Systems

5 Bodies

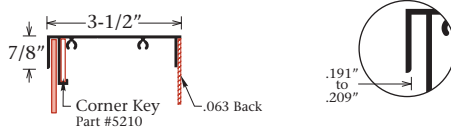
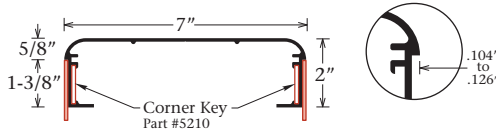
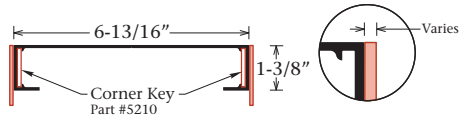
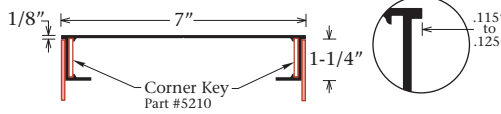
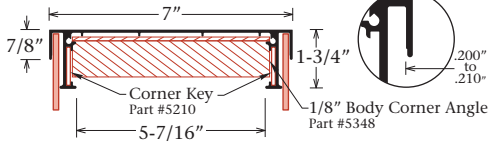

1 Radius End

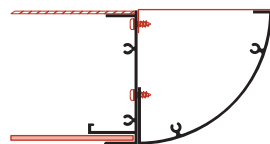
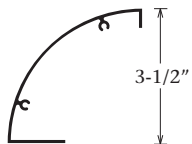

3 Posts

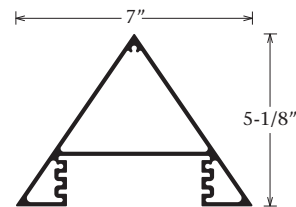
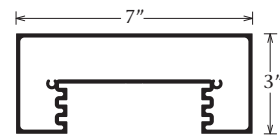
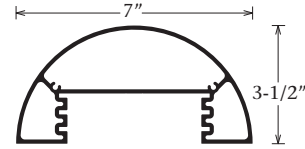

1 Reveal

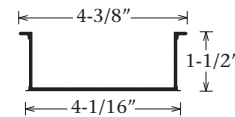

- One Reveal Shape:
- Easily attaches to all four (4) 7" non-illuminated bodies
 - Delivers three (3) reveal positions
 - Fills the post below the panel

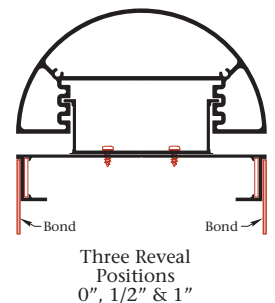
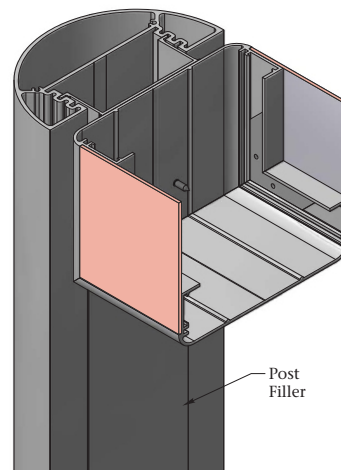

Note: All dimensions are subject to the tolerance standards of the aluminum extrusion industry. Profile drawings are illustrative and rounded to the nearest 1/16".

Architectural System Specifications

Non-Hingeable Sign Cabinet Bodies and Covers

Double Sided Systems

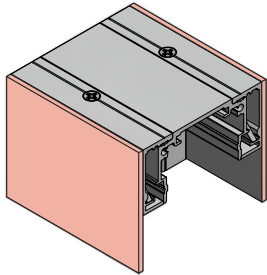

Frameless Cover
Part #1693

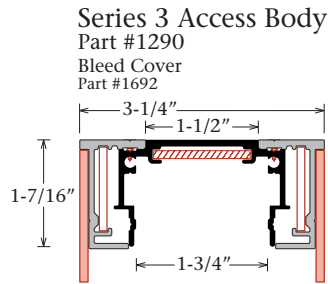

Slide Cover
Part #1694

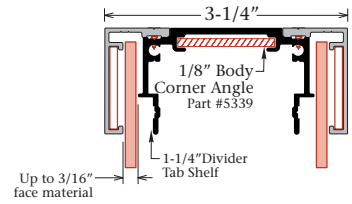

Series 4 Access Body
Part #1390
Frameless Cover
Part #1693

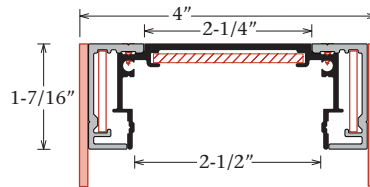

Radius Slide Cover
Part #1695

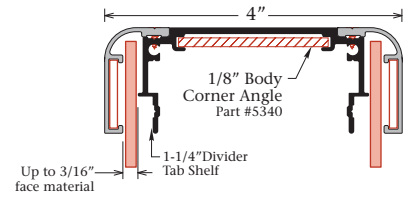

Single Sided Systems

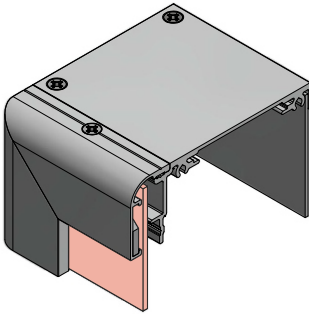

Radius Slide Cover
Part #1695

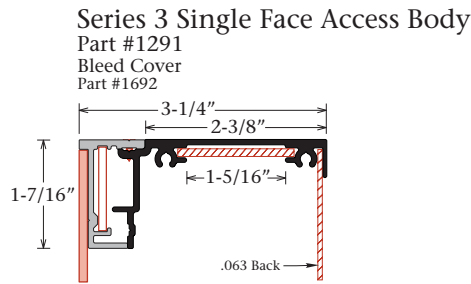

Slide Cover
Part #1694

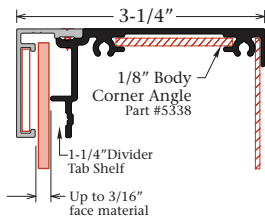

Series 4 Single Face Access Body
Part #1391
Frameless Cover
Part #1693

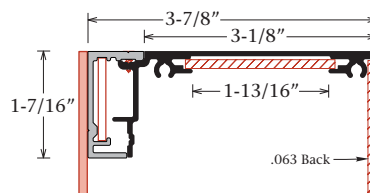

Radius Slide Cover
Part #1695

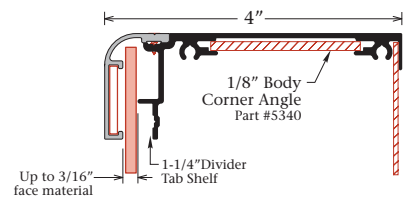

Note: The Series 3 & 4 Access Bodies with Covers are designed to integrate with the Series 2, Series 3 and Series 4 posts. See pages 58-60 for more information.

Cover Options

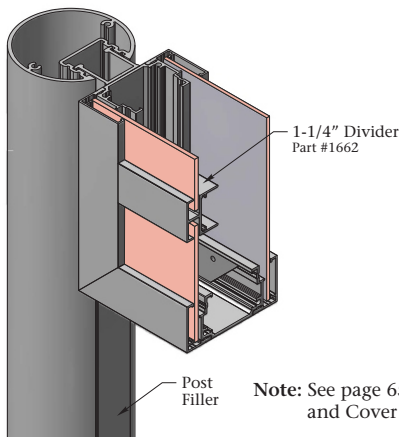

Note: See page 65 for 1-1/4" Divider and Cover specifications.

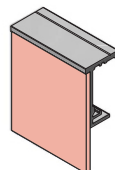

Bleed Cover
Part #1692

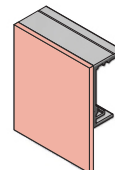

Frameless Cover
Part #1693

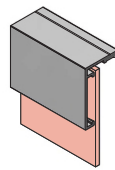

Slide Cover
Part #1694

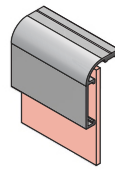

Radius Slide Cover
Part #1695

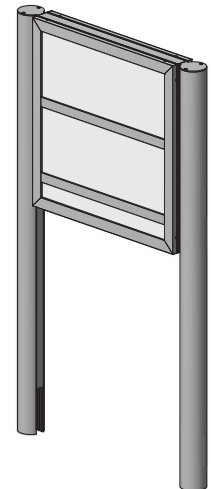

Architectural System Specifications

Hingeable 7" Post and Panel Systems

1 Body

See below

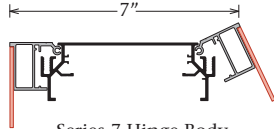

Series 7 Hinge Body and Bleed Retainers

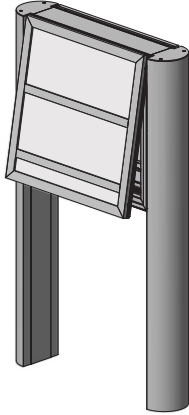

10 Retainers

See page 64-65

1 Reveal

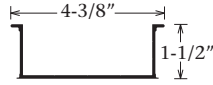

Series 7 Reveal Part #1550

- One Reveal Shape:
- Easily attaches to the Hinge Body
 - Delivers three (3) reveal positions
 - Fills the post below the panel

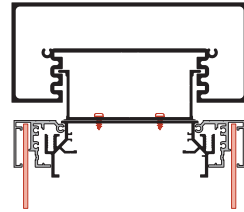

Three Reveal Positions
0", 1/2" & 1"

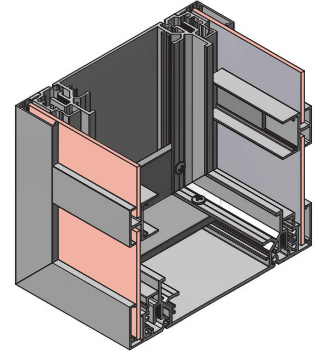

3 Posts

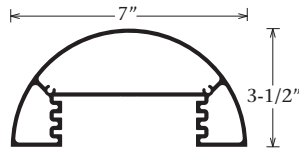

Radius Post Part #1500

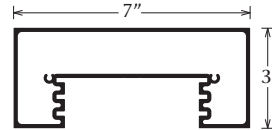

Rectangular Post Part #1510

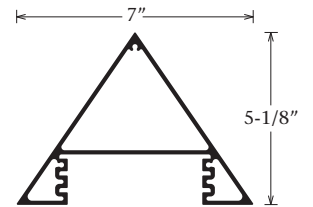

Triangular Post Part #1530

Hingeable Sign Cabinet Bodies

Series 12 Hinge Body

Part #1612

(Section view through top)

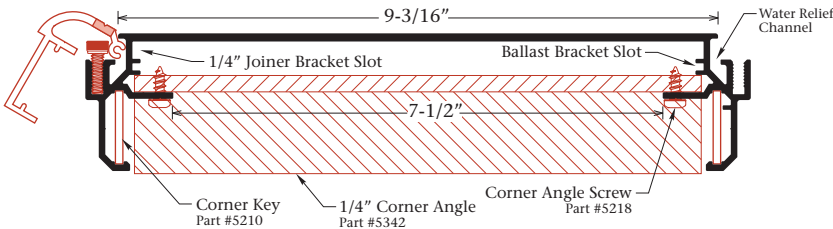

Series 7 Hinge Body

Part #1592

(Section view through top)

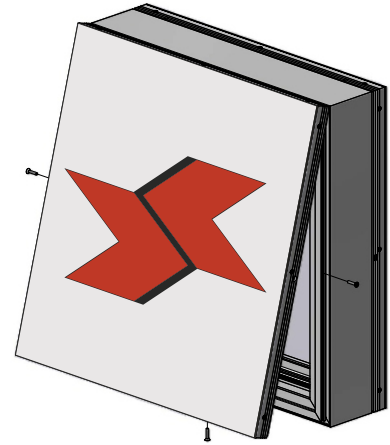
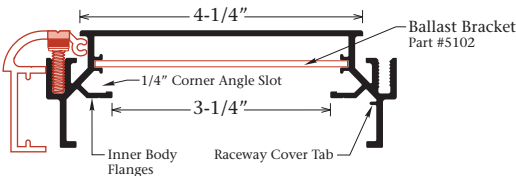

Series 6 Single Face Body

Part #1602

(Section view through top)

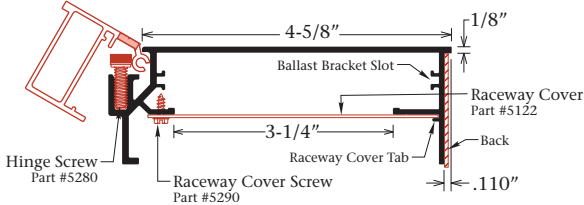

Series 7-12 Retro Body

Part #1600

(Section view through side/bottom)

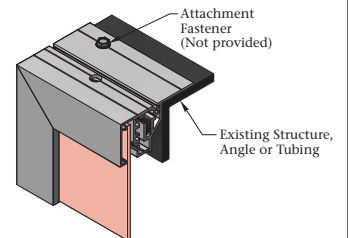
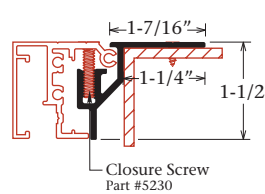

Note: See page 46 for all body components.

Note: It is recommended to use safety chains and prop-bars on hingeable faces.

Note: All dimensions are subject to the tolerance standards of the aluminum extrusion industry. Profile drawings are illustrative and rounded to the nearest 1/16".

Architectural System Specifications

Hingeable Retainers

Radius Edge Face Retainers

1/4 Round Retainer

Part #1640

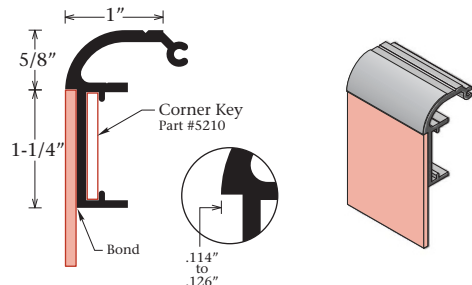

Extended 1/4 Round Retainer

Part #1650

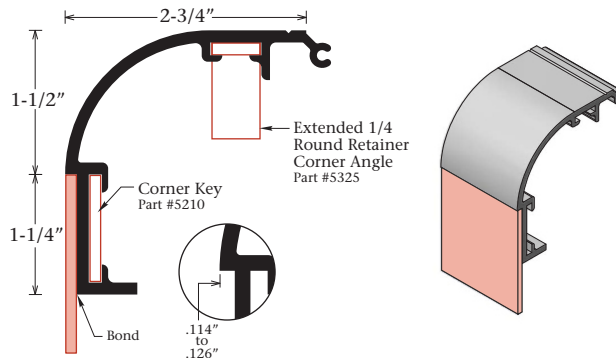

Extended 1/4 Round Retainer with Reveal

*Part #1655

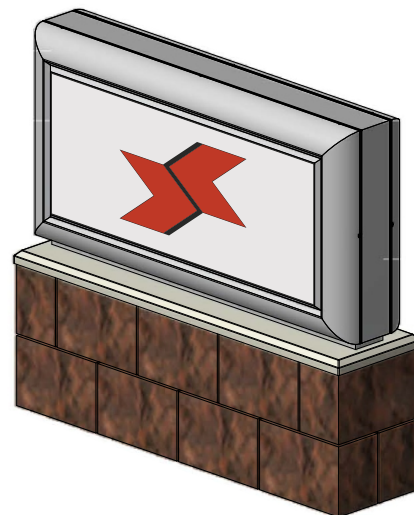
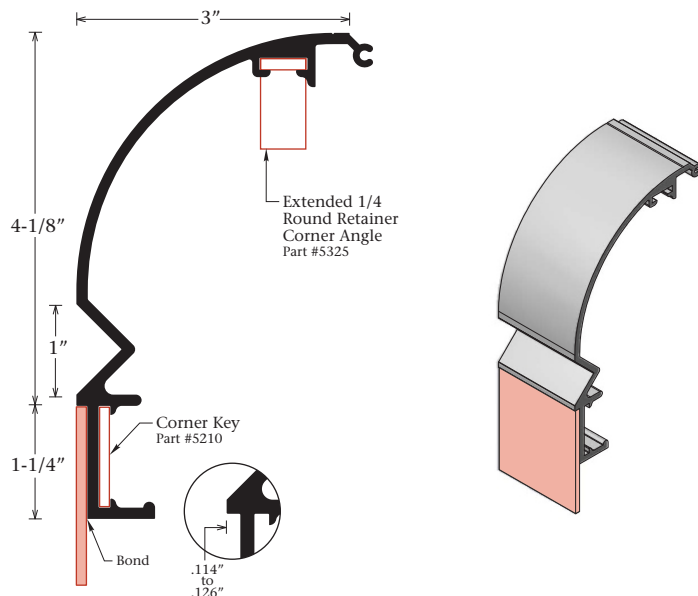

Note: The Hingeable Retainers are designed to integrate with all of the Architectural Hinge Bodies. See page 63 for more information.

Beveled Edge Face Retainer

Beveled Retainer

Part #1656

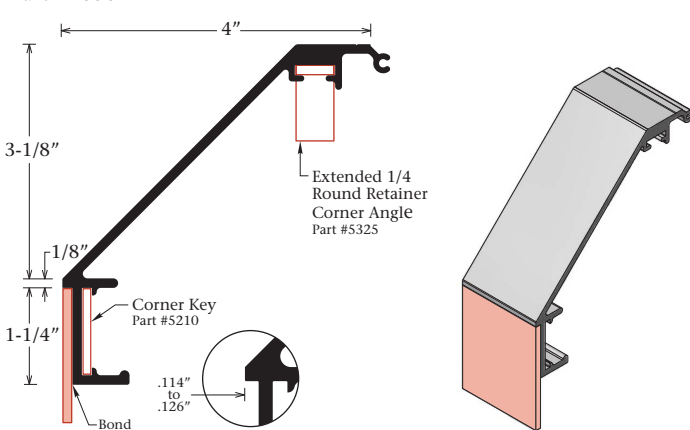

Bleed Pan Face Retainer

Frameless Rigid Retainer

Part #1628

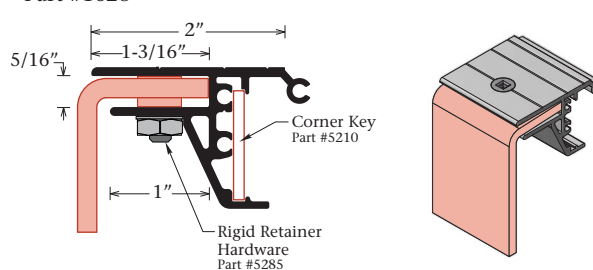

Note: It is recommended to use safety chains and prop-bars on hingeable faces.

*Available in mill run only

Architectural System Specifications

ARCHITECTURAL

Hingeable Retainers and Divider

Framed Face Retainers

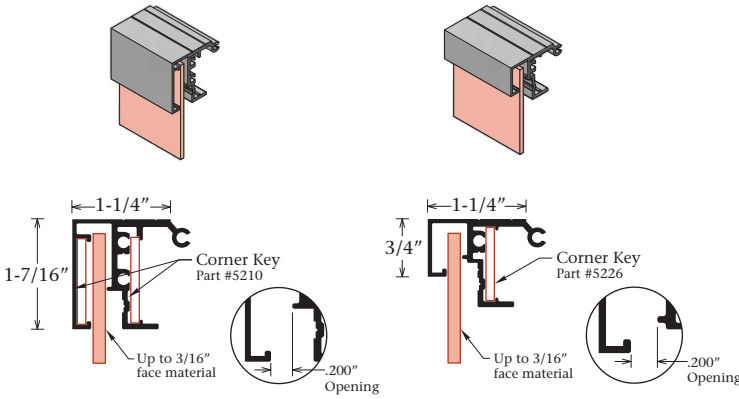

Slide Retainer
Part #1624

3/4" Slide Retainer
Part #1626

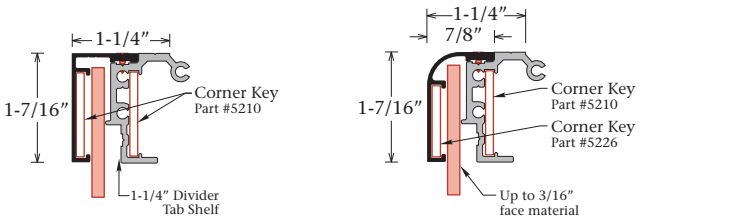

Slide Cover
Part #1694
Access Frame
Part #1690

Radius Slide Cover
Part #1695
Access Frame
Part #1690

Flush Face Retainers

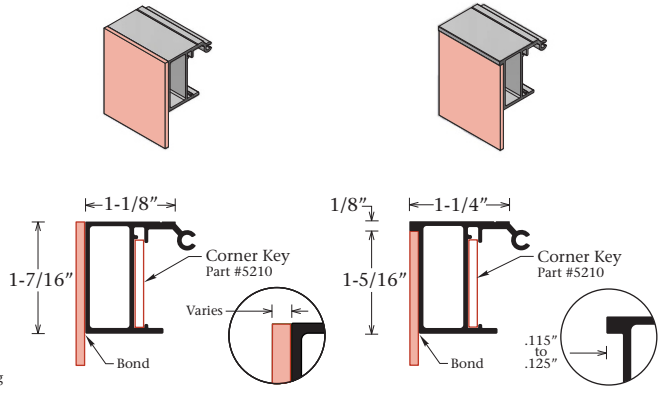

Frameless Retainer
Part #1631

Bleed Retainer
Part #1632

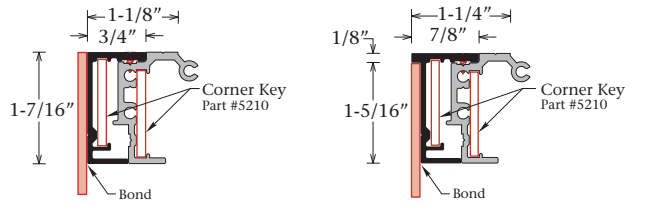

Frameless Cover
Part #1693
Access Frame
Part #1690

Bleed Cover
Part #1692
Access Frame
Part #1690

Framed Face Divider

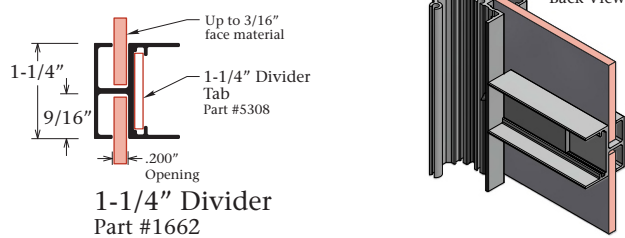

1-1/4" Divider
Part #1662

Monolithic Edges

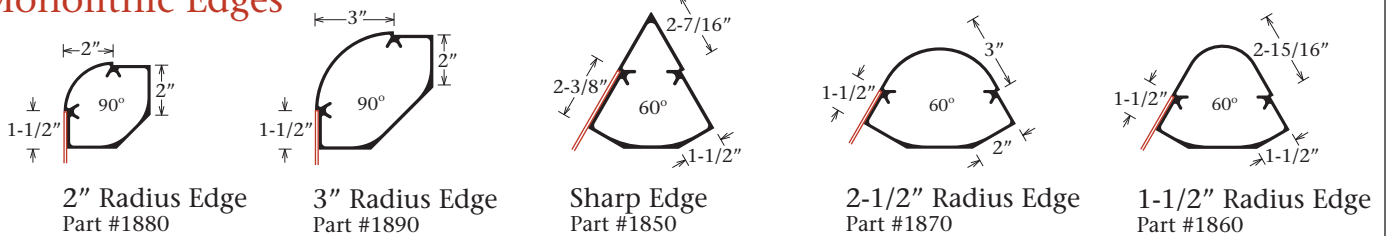

2" Radius Edge
Part #1880

3" Radius Edge
Part #1890

Sharp Edge
Part #1850

2-1/2" Radius Edge
Part #1870

1-1/2" Radius Edge
Part #1860

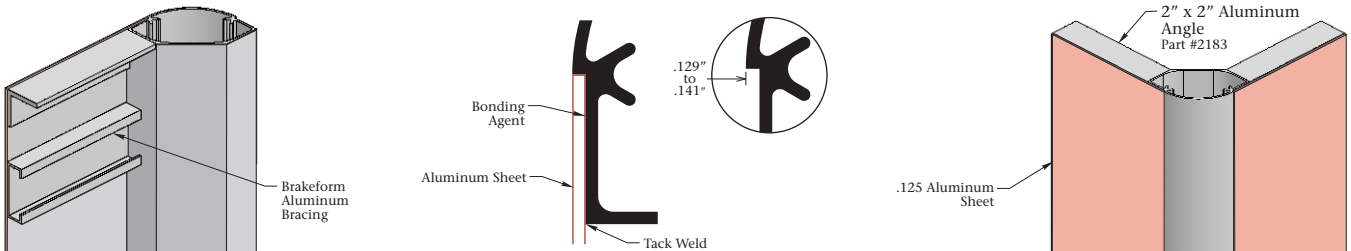

Note: It is recommended to use safety chains and prop-bars on hingeable faces.

Note: All dimensions are subject to the tolerance standards of the aluminum extrusion industry. Profile drawings are illustrative and rounded to the nearest 1/16".

Architectural System Specifications

Insert Panel Systems

See pages 63 for body and post options, reveal positions and additional information.

Hingeable

Bodies



Series 12 Hinge Body
Part #1612



Series 7 Hinge Body
Part #1592



Series 6 Single Face Body
Part #1602



Series 7-12 Retro Body
Part #1600

Insert Panels / Adaptors

- 8" Panel, Part #1678
- 6" Panel, Part #1676
- 4" Panel, Part #1674
- Aluminum Adaptor Part #1679
- Plastic Adaptor Part #1689

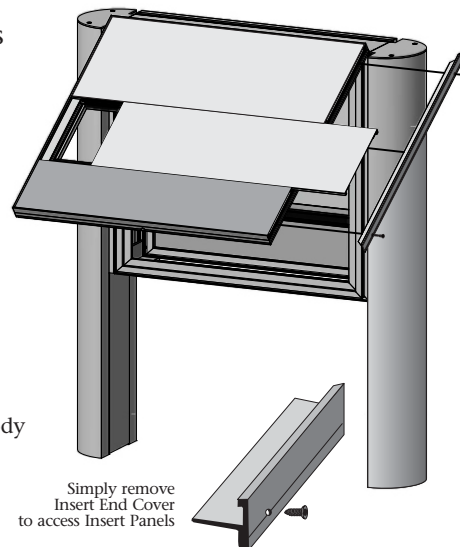

Simply remove Insert End Cover to access Insert Panels

Header Panel Retainers

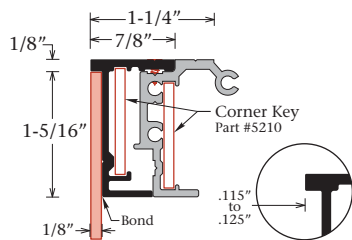

Bleed Cover
Part #1692
Access Frame
Part #1690

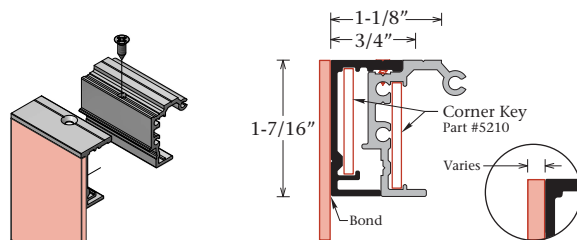

Frameless Cover
Part #1693
Access Frame
Part #1690

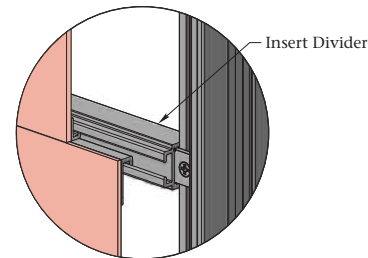

Flush Insert Panel Retainers

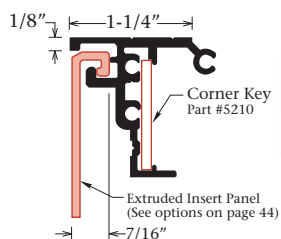

Insert Retainer
Part #1666

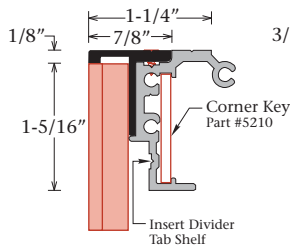

Insert End Cover
Part #1696
Access Frame
Part #1690

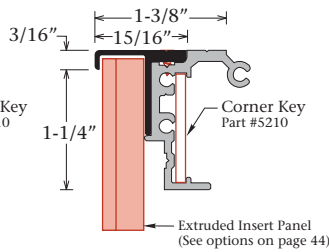

Extended Insert End Cover
Part #1698
Access Frame
Part #1690

Flush Insert Panel Divider

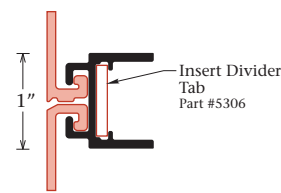

Insert Divider
Part #1668

Non-Hingeable

Series 3 Access Body
Part #1290

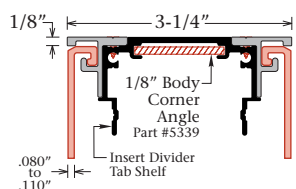

Insert Top/Bottom Cover
Part #1292

Series 4 Access Body
Part #1390

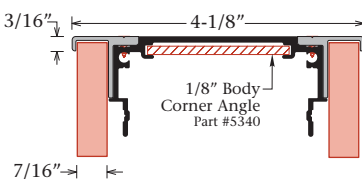

Extended Insert End Cover
Part #1698

Series 3 Single Face Access Body
Part #1291

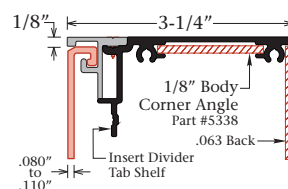

Insert Top/Bottom Cover
Part #1292

Series 4 Single Face Access Body
Part #1391

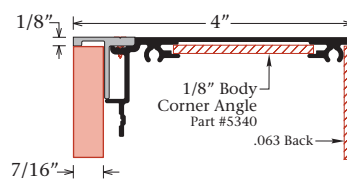

Insert End Cover
Part #1696

Note: All of the Covers above integrate with all four (4) Access Body options. See page 62 for more information.

Note: It is recommended to use safety chains and prop-bars on hingeable faces.

Architectural System Specifications

Radius Ends

3-1/2" Radius Extrusion

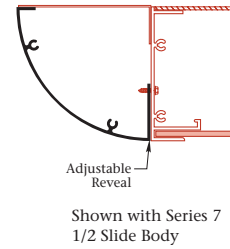
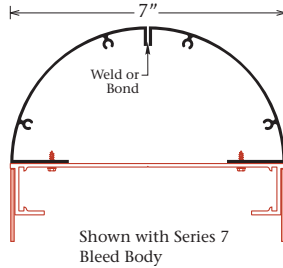
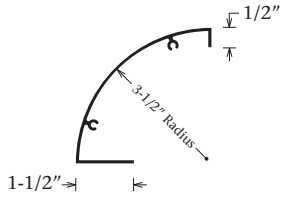
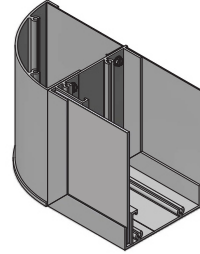
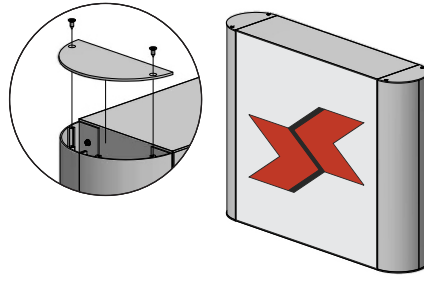
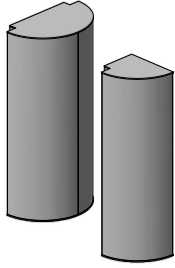

3-1/2" 1/4 Round End
Part #1670

Shown with Series 7
Bleed Body

Shown with Series 7
1/2 Slide Body

6" Radius Extrusion

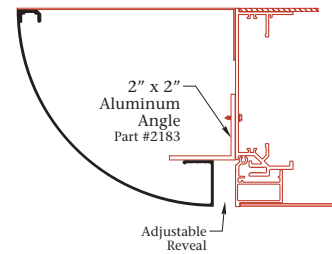
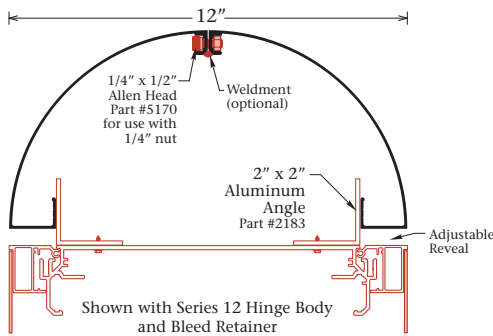
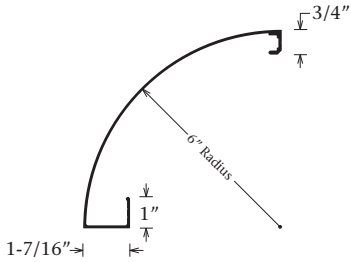
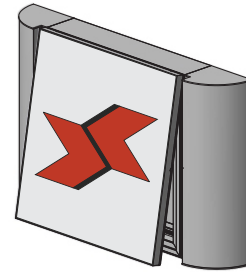
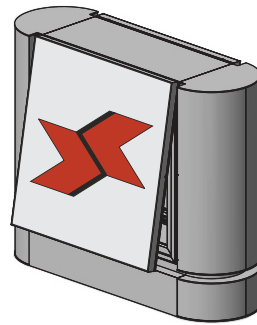
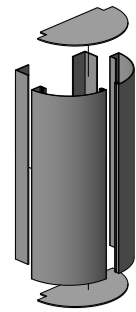

6" 1/4 Round End
Part #1671

Shown with Series 12 Hinge Body
and Bleed Retainer

Shown with Series 7 Single Face Body
and Bleed Retainer

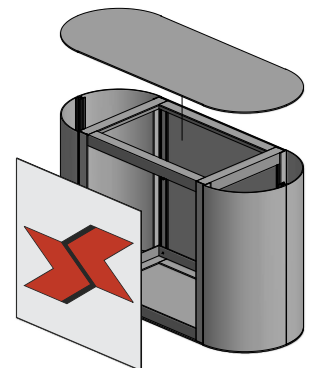
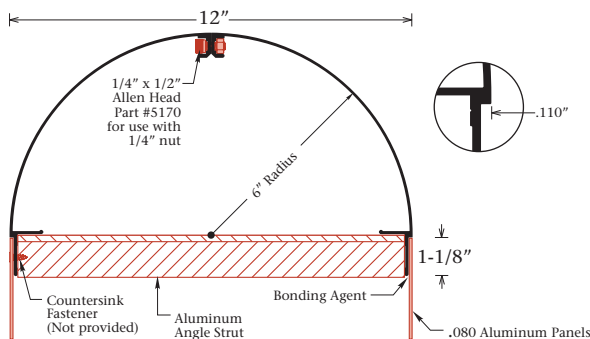
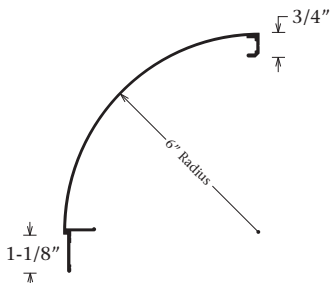

6" 1/4 Round Pole Cover
Part #1672

Countersink Fastener
(Not provided)

Aluminum Angle Strut

Bonding Agent
.080 Aluminum Panels

Architectural System Combinations

Mix and Match to Create Endless Designs

Using and combining Series 1, 2, 3, 4, 7, Copy Bars, Panel Adaptors, Dividers and Posts

Create with panels and posts

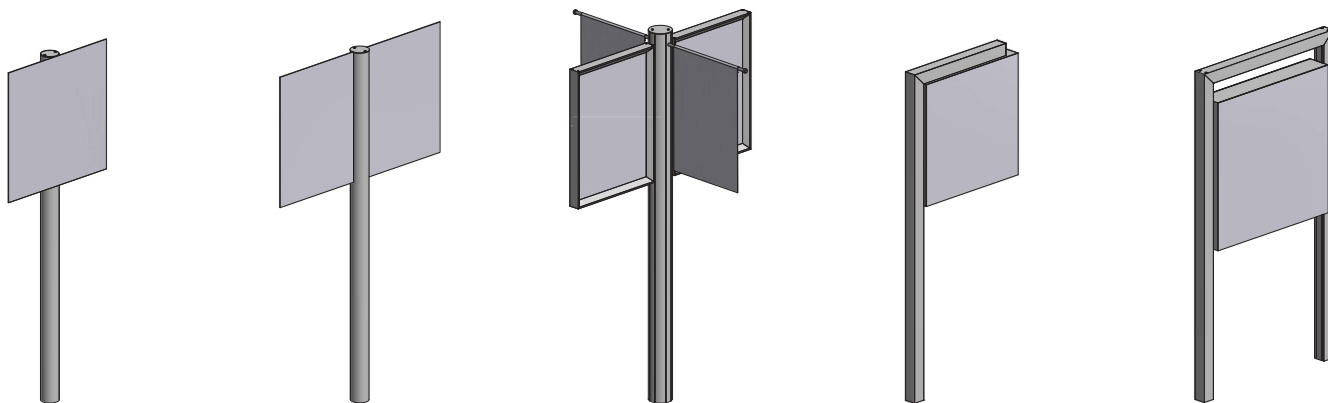

Create with shapes, multiple panels and posts

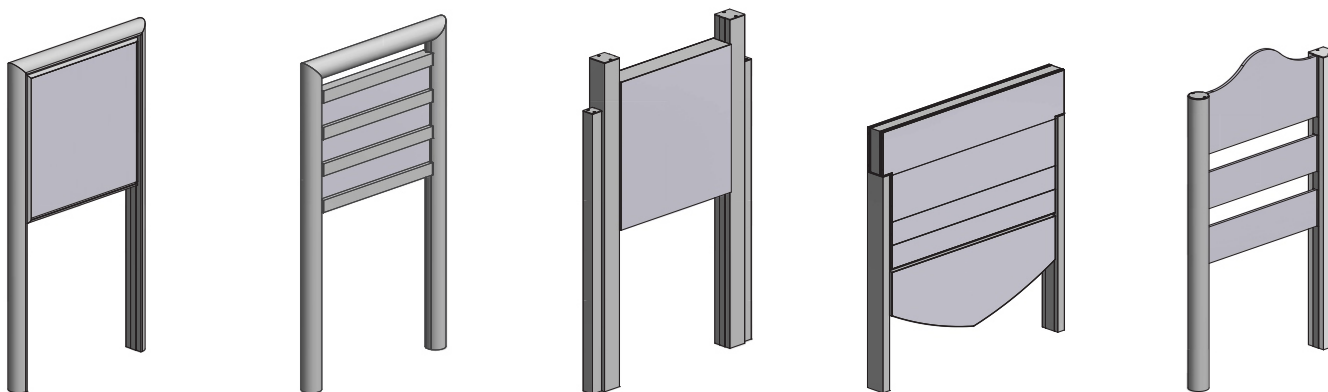

Create with angles, reveals and mounting methods

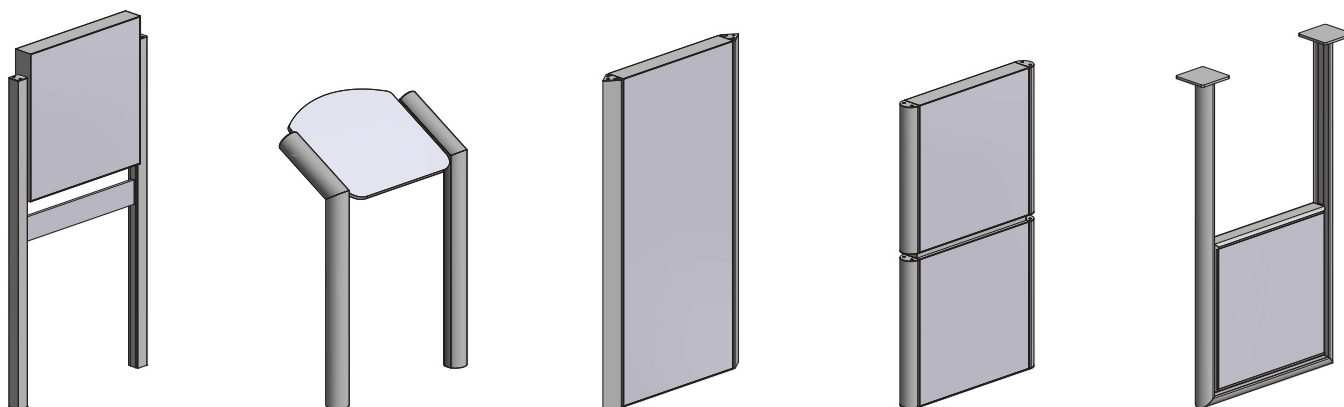

RTS Post & Panel Systems

3-1/4" Round Post

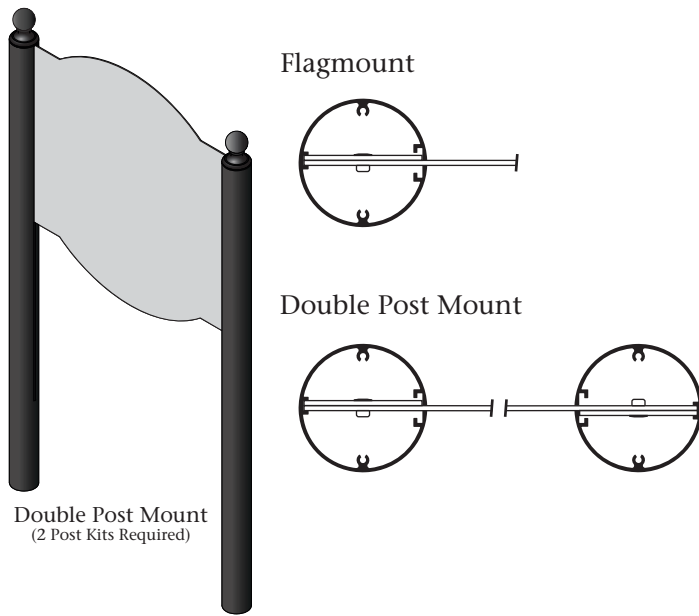

3-1/4" Square Post

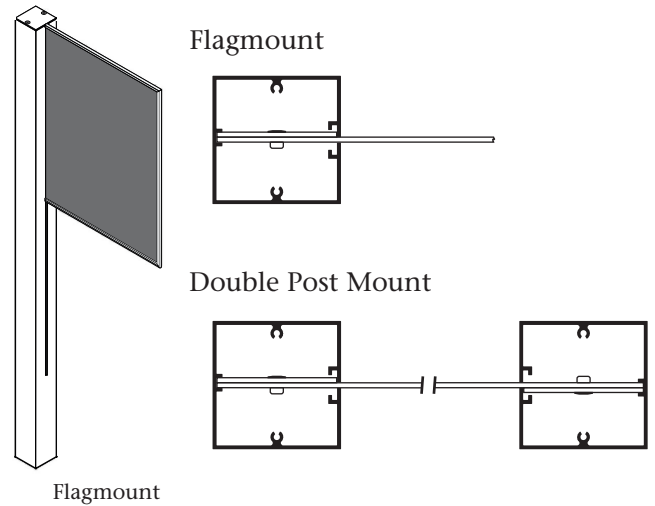

RTS Post Kit Includes:

- 48" slot to accommodate up to 48" high, 1/8" or 3mm panel
- One (1) adjustable, 48" Post Filler to accommodate a panel less than 48" high
- One (1) 1/8" Post Cap with tow (2) countersunk cap screws
- One (1) adjustable 94" Panel Trim for 1/8" or 3 mm hollow core panel material
- Two (2) 6" Locking Strips
- One (1) 94" or 144" powder coated gloss white or gloss black RTS Post

Note: Face material not included.

Round Post

94" Post
Part #RTS-1017-8' WHT
Part #RTS-1017-8' BLK
\$211.61 each

144" Post
Part #RTS-1017-12' WHT
Part #RTS-1017-12' BLK
\$303.30 each

Available in powder coated gloss white and gloss black finishes.

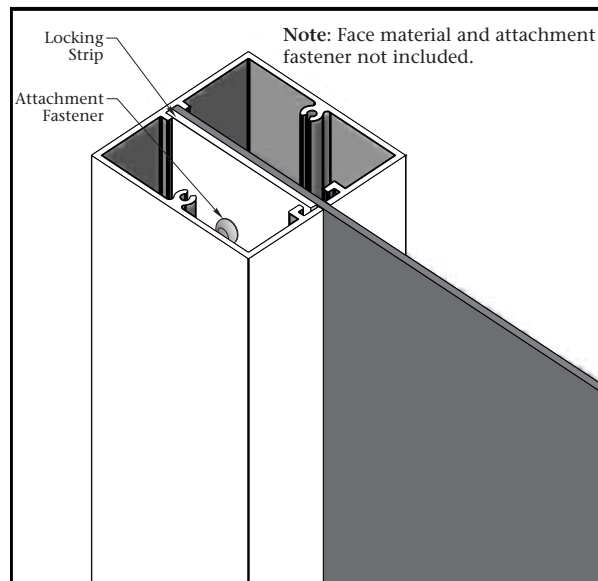

Square Post







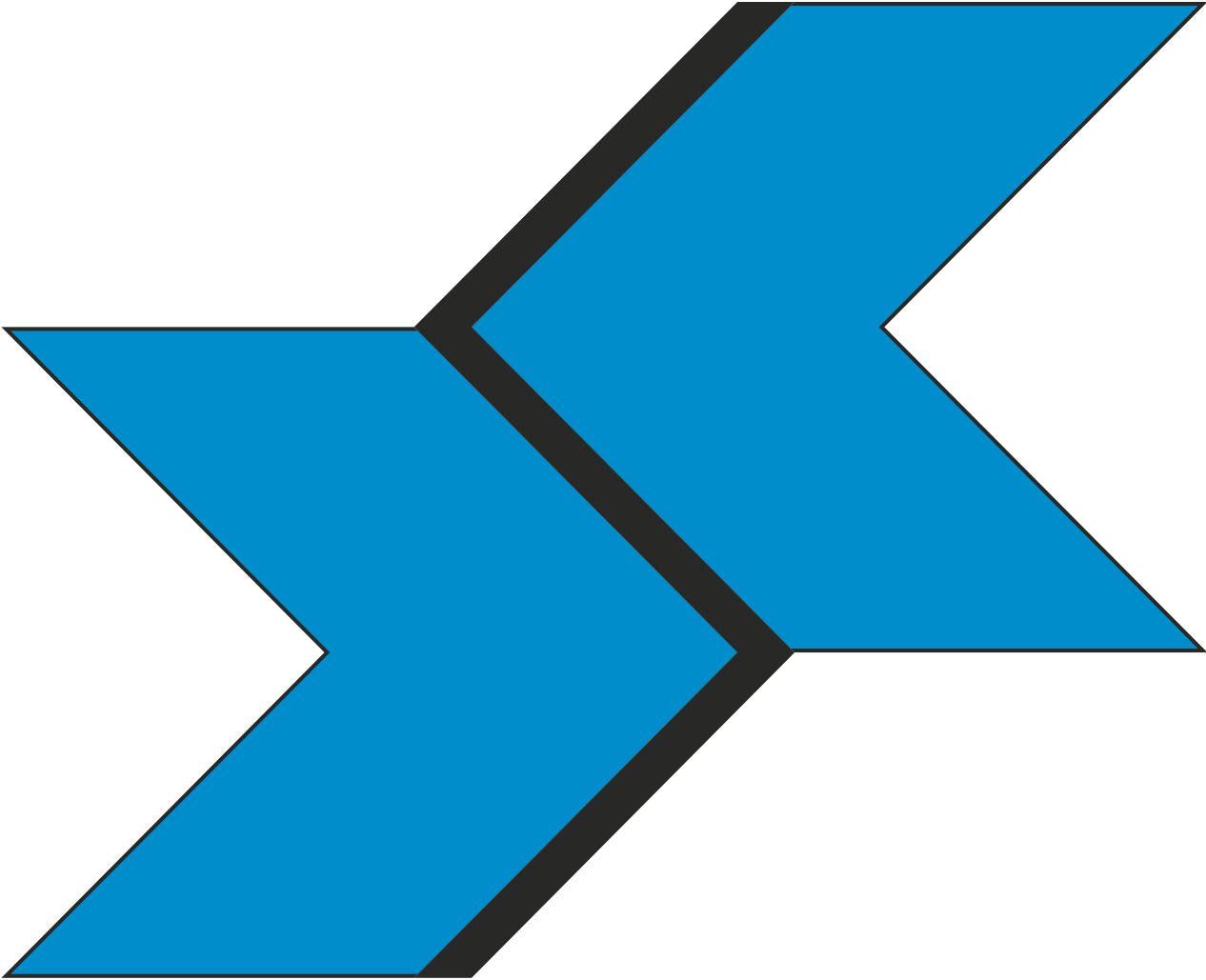







94" Post
Part #RTS-1015-8' WHT
Part #RTS-1015-8' BLK
\$230.41 each

144" Post
Part #RTS-1015-12' WHT
Part #RTS-1015-12' BLK
\$331.51 each

Available in powder coated gloss white and gloss black finishes.



Extrusions Priced by the Length

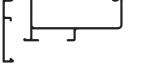







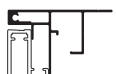

	Part	Part Number	Length	Mill Finish	Dk. Bronze
Sign Cabinet Bodies					
	1Part 12" Double Face Body	1924 1924P	24'-8"	\$594.59 <i>Cost per Foot</i> 24.10	\$763.69 30.96
	2Part 12" Double Face Body	1929 1929P	24'-8"	457.45 <i>Cost per Foot</i> 18.55	587.02 23.80
	1Part 9" Double Face Body	1923 1923P	24'-8"	480.79 <i>Cost per Foot</i> 19.49	626.03 25.38
	2Part 9" Double Face Body	1928 1928P	24'-8"	357.19 <i>Cost per Foot</i> 14.48	465.05 18.85
	1Part 6" Double Face Body	1931 1931P	24'-6"	372.21 <i>Cost per Foot</i> 15.19	483.43 19.73
	2Part 6" Double Face Body	1936 1936P	24'-6"	225.76 <i>Cost per Foot</i> 9.21	293.37 11.97
	1Part 8" Single Face Body	1922 1922P	24'-8"	416.83 <i>Cost per Foot</i> 16.90	543.10 22.02
	2Part 8" Single Face Body	1927 1927P	24'-8"	346.89 <i>Cost per Foot</i> 14.06	453.67 18.39
	1Part 6" Single Face Body	1921 1921P	24'-8"	351.80 <i>Cost per Foot</i> 14.26	456.94 18.52
	2Part 6" Single Face Body	1926 1926P	24'-8"	282.36 <i>Cost per Foot</i> 11.45	366.94 14.88
Retainers					
	2Part Retainer	1944 1944P	24'-8"	55.83 <i>Cost per Foot</i> 2.26	73.70 2.99
	2Part 6" Double Face Retainer	1954 1954P	24'-6"	68.62 <i>Cost per Foot</i> 2.80	90.62 3.70
	2Part Extended Retainer	1940 1940P	24'-8"	191.30 <i>Cost per Foot</i> 7.76	251.50 10.20
	2Part Extended Frame	1955 1955P	24'-8"	120.09 <i>Cost per Foot</i> 4.87	156.67 6.35
	2Part Large Extended Retainer	1939 1939P	24'-8"	254.73 <i>Cost per Foot</i> 10.33	335.52 13.60

Extrusions available in full lengths and kits.

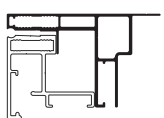
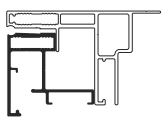
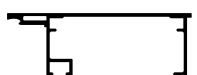
Note: All dimensions are subject to the tolerance standards of the aluminum extrusion industry. Profile drawings are illustrative and rounded to the nearest 1/16".

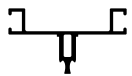
Current pricing available at www.signcomp.com or call SignComp Customer Service 877-784-0405















Extrusions by the Length

	Part	Part Number	Length	Mill Finish	Dk. Bronze
Dividers					
	2Part Divider	1905 1905P	24'-0"	\$124.45 <i>Cost per Foot</i> 5.19	\$156.09 6.50
	1-1/2" Standard Divider	1910*	24'-6"	82.38 <i>Cost per Foot</i> 3.36	N/A
	2-1/2" Standard Divider	1920*	24'-6"	118.44 <i>Cost per Foot</i> 4.83	N/A
Vandal Systems					
	2Part Inner Frame	1960 1960P	24'-8"	133.33 <i>Cost per Foot</i> 5.41	174.00 7.05
	2Part Outer Frame	1942 1942P	24'-6"	103.39 <i>Cost per Foot</i> 4.22	135.15 5.52
	2Part Large Inner Frame	1959 1959P	24'-8"	324.13 <i>Cost per Foot</i> 13.14	421.70 17.10
	2Part Large Outer Frame	1941 1941P	24'-6"	233.53 <i>Cost per Foot</i> 9.53	305.25 12.46
Menu Board System					
	Menu 5" Single Face Body	1802	24'-4"	273.98 <i>Cost per Foot</i> 11.26	N/A
	Menu Door Frame	1804	24'-4"	128.66 <i>Cost per Foot</i> 5.29	N/A
	Menu External Divider	1806	16'-2"	122.38 <i>Cost per Foot</i> 7.57	N/A
	Menu Internal Divider	1807	16'-2"	46.53 <i>Cost per Foot</i> 2.88	N/A
	Menu Clip	1809	16'-2"	32.18 <i>Cost per Foot</i> 1.99	N/A
Edge Lit					
	Edge Lit LED 1/2 Round	1995	12'-4"	186.45 <i>Cost per Foot</i> 15.12	N/A
	Edge Lit LED 1/4 Round	1996	12'-4"	152.86 <i>Cost per Foot</i> 12.39	N/A

Extrusions available in full lengths and kits.
*Available in full lengths only.

Extrusions by the Length

Current pricing available at www.signcomp.com or call SignComp Customer Service 877-784-0405

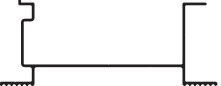
Part	Part Number	Length	Mill Finish	Dk. Bronze
Snap Frames and Covers				
 Snap Frame	1899	20'-0"	\$34.30 <i>Cost per Foot</i> 1.72	N/A
 Large Snap Frame	1898	20'-0"	39.79 <i>Cost per Foot</i> 1.99	N/A
 Snap Frame Radius Cover	1896 1896A	20'-0"	22.40 <i>Cost per Foot</i> 1.12	**44.12 2.21
 Snap Frame Flat Cover	1895 1895A	20'-0"	23.44 <i>Cost per Foot</i> 1.17	**45.42 2.27
Wall Frames				
 3/4" Wall Frame	1948M 1948	24'-4"	66.96 <i>Cost per Foot</i> 2.75	**108.54 4.46
 1-3/8" Wall Frame	1949M 1949	24'-4"	92.27 <i>Cost per Foot</i> 3.79	**136.87 5.62
Standard Moldings				
 1-3/8" L-Molding	1943 1943B	24'-4"	56.69 <i>Cost per Foot</i> 2.33	*74.87 3.08
 1" H-Molding	1945 1945P	24'-4"	52.39 <i>Cost per Foot</i> 2.15	68.96 2.83
 1" Z-Molding	1946	24'-4"	63.07 <i>Cost per Foot</i> 2.59	82.89 3.41
 1.5" Z-Molding	1947	24'-4"	93.56 <i>Cost per Foot</i> 3.84	121.39 4.99
Socket and Ballast Raceways				
 Large Socket Raceway	1983	24'-2"	101.48 <i>Cost per Foot</i> 4.20	N/A
 Socket Raceway	1984	24'-2"	145.78 <i>Cost per Foot</i> 6.03	N/A
 Socket Raceway II	1985	24'-2"	87.10 <i>Cost per Foot</i> 3.60	N/A
 Socket Raceway Cover	1987	24'-2"	21.62 <i>Cost per Foot</i> .89	N/A
 Ballast/Power Supply Raceway	1969	24'-2"	160.44 <i>Cost per Foot</i> 6.64	N/A













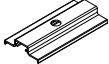

Extrusions available in full lengths only.
Snap Frames and Wall Frames available in full lengths and kits.

**Clear anodized finish
*Matte Black finish

Note: All dimensions are subject to the tolerance standards of the aluminum extrusion industry. Profile drawings are illustrative and rounded to the nearest 1/16".





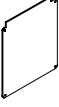







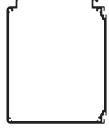

Extrusions Priced by the Length with Components

	Part	Part Number	Length/ Piece	Mill Finish	Price Each
Channel Letter Raceways 5" Narrow CLR	 1 Piece 5" Narrow Channel Letter Raceway	1970N	24'-2"	\$322.22 <i>Cost per Foot</i> 13.33	N/A
	 2 Piece 5" Channel Letter Raceway - Front	1971	24'-2"	163.65 <i>Cost per Foot</i> 6.77	N/A
	 2 Piece 5" Narrow Channel Letter Raceway - Back	1972N	24'-2"	152.03 <i>Cost per Foot</i> 6.29	N/A
	 5" Narrow Channel Letter Raceway Cover	1976N	24'-3"	57.35 <i>Cost per Foot</i> 2.36	N/A
	 5" Narrow Channel Letter Raceway Brace/Bracket	1974N	12'-2"	29.28 <i>Cost per Foot</i> 2.41	N/A
	 5" Narrow Channel Letter Raceway Lifting Bracket	1975N	12'-0"	38.79 <i>Cost per Foot</i> 3.23	N/A
	 5" Narrow Channel Letter Raceway Brace/Bracket 2-15/16" x 2" x .090	5972N-5"	2"	N/A	\$2.15
	 5" Narrow Channel Letter Raceway Lifting Bracket 2-15/16" x 6" x .090	5875N-5"	6"	N/A	2.76
	 5" Narrow Channel Letter Raceway End Cap 5-7/16" x 3-1/2" x .090	5987N-5"	ea	N/A	13.19
	5" CLR	 2 Piece 5" Channel Letter Raceway - Front	1971	24'-2"	163.65 <i>Cost per Foot</i> 6.77
 2 Piece 5" Channel Letter Raceway - Back		1972	24'-2"	182.17 <i>Cost per Foot</i> 7.54	N/A
 5" Channel Letter Raceway Cover		1976	24'-3"	87.68 <i>Cost per Foot</i> 3.62	N/A
 5" Channel Letter Raceway Brace/Bracket		1974	12'-2"	45.73 <i>Cost per Foot</i> 3.76	N/A
 5" Channel Letter Raceway Brace/Bracket 4-13/16" x .090		5972-5"	2"	N/A	3.00
 5" Channel Letter Raceway Lifting Bracket 1-3/4" x 1-3/4" x 1/4"		5976-5"	4-3/8"	N/A	6.58
 5" Channel Letter Raceway End Cap 5-7/16" x 5-3/8" x .090		5987-5"	ea	N/A	15.28

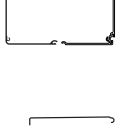

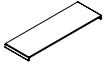
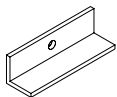
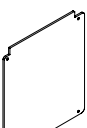
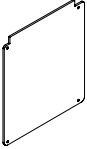

Extrusions available in full lengths only.

Extrusions Priced by the Length with Components

Part	Part Number	Length/ Piece	Mill Finish	Price Each	
Channel Letter Raceways					
8" Narrow CLR					
	2 Piece 8" Channel Letter Raceway - Front	1981	24'-2"	\$262.45 <i>Cost per Foot 10.86</i>	N/A
	2 Piece 8" Narrow Channel Letter Raceway - Back	1982N	24'-2"	241.05 <i>Cost per Foot 9.97</i>	N/A
	8" Narrow Channel Letter Raceway Cover	1986N	24'-3"	77.27 <i>Cost per Foot 3.19</i>	N/A
	8" Narrow Channel Letter Raceway Brace/Bracket	1979N	12'-2"	36.67 <i>Cost per Foot 3.01</i>	N/A
	8" Narrow Channel Letter Raceway Brace/Bracket 3-13/16" x 2" x .090	5972N-8"	ea	N/A	\$3.51
	8" Narrow Channel Letter Raceway End Cap 8-1/2" x 4-5/16" x .090	5987N-8"	ea	N/A	17.26
8" CLR					
	1 Piece 8" Channel Letter Raceway	1980	24'-2"	827.69 <i>Cost per Foot 34.25</i>	N/A
	2 Piece 8" Channel Letter Raceway - Front	1981	24'-2"	262.45 <i>Cost per Foot 10.86</i>	N/A
	2 Piece 8" Channel Letter Raceway - Back	1982	24'-2"	289.45 <i>Cost per Foot 11.98</i>	N/A
	8" Channel Letter Raceway Cover	1986	24'-3"	125.92 <i>Cost per Foot 5.19</i>	N/A
	8" Channel Letter Raceway Brace/Bracket	1979	12'-2"	62.70 <i>Cost per Foot 5.15</i>	N/A
	8" 1 Piece Channel Letter Raceway Brace 6-3/16" x 2" x .090	5972(1PC)-8"	2"	N/A	3.84
	8" Channel Letter Raceway Brace/Bracket 6-3/4" x .090	5972-8"	2"	N/A	3.84
	8" Channel Letter Raceway Lifting Bracket 1-3/4" x 1-3/4" x 1/4"	5976-8"	6-3/8"	N/A	7.40
	8" 1 Piece Channel Letter Raceway End Cap 8-9/16" x 7-5/16" x .090	5987(1PC)-8"	ea	N/A	18.98
	8" Channel Letter Raceway End Cap 8-1/2" x 7-5/16" x .090	5987-8"	ea	N/A	18.98

Extrusions available in full lengths only.

Extrusion Bundles Priced by the Length

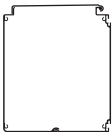
Part	Part Number	Length	Mill Finish
Channel Letter Raceways			
 <p>1 Piece 5" Narrow Channel Letter Raceway</p> <ul style="list-style-type: none"> • One (1) 1 Piece 5" Narrow Channel Letter Raceway • One (1) 5" Narrow Channel Letter Raceway Cover <p>Not Included: Hardware, Brace/Brackets, Mounting Clips or End Caps</p>	B1970N	24'-2"	\$379.55 <i>Cost per Foot 15.71</i>
 <p>2 Piece 5" Narrow Channel Letter Raceway</p> <ul style="list-style-type: none"> • One (1) 2 Piece 5" Channel Letter Raceway - Front • One (1) 2 Piece 5" Narrow Channel Letter Raceway - Back • One (1) 5" Narrow Channel Letter Raceway Cover <p>Not Included: Hardware, Brace/Brackets, Mounting Clips or End Caps</p>	B1972N	24'-2"	373.05 <i>Cost per Foot 15.44</i>
 <p>2 Piece 5" Channel Letter Raceway</p> <ul style="list-style-type: none"> • One (1) 2 Piece 5" Channel Letter Raceway - Front • One (1) 2 Piece 5" Channel Letter Raceway - Back • One (1) 5" Channel Letter Raceway Cover <p>Not Included: Hardware, Brace/Brackets, Mounting Clips or End Caps</p>	B1972	24'-2"	433.53 <i>Cost per Foot 17.94</i>
 <p>2 Piece 8" Narrow Channel Letter Raceway</p> <ul style="list-style-type: none"> • One (1) 2 Piece 8" Channel Letter Raceway - Front • One (1) 2 Piece 8" Narrow Channel Letter Raceway - Back • One (1) 8" Narrow Channel Letter Raceway Cover <p>Not Included: Hardware, Brace/Brackets, Mounting Clips or End Caps</p>	B1982N	24'-2"	580.74 <i>Cost per Foot 24.03</i>
 <p>2 Piece 8" Channel Letter Raceway</p> <ul style="list-style-type: none"> • One (1) 2 Piece 8" Channel Letter Raceway - Front • One (1) 2 Piece 8" Channel Letter Raceway - Back • One (1) 8" Channel Letter Raceway Cover <p>Not Included: Hardware, Brace/Brackets, Mounting Clips or End Caps</p>	B1982	24'-2"	677.82 <i>Cost per Foot 28.05</i>

Channel Letter Raceway Splicing Guidelines

- Cut two 6" Channel Letter Raceway Brace/Brackets
- Insert into the top and bottom of one section of raceway

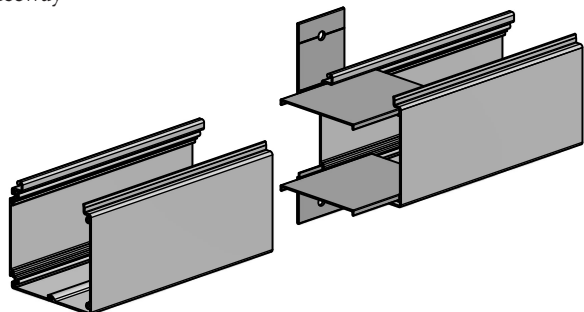

- Connect both sections of raceway together by sliding the brace/brackets into the second piece of raceway
- Weld or bond both sides of the top and bottom to secure the splice

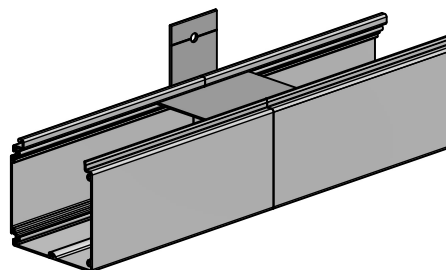

Extrusions Priced by the Length \ Standard System Accessories







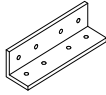
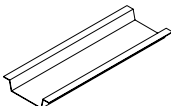
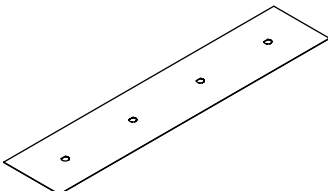
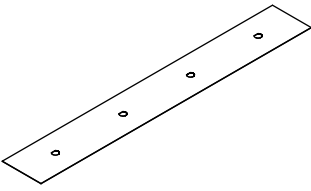
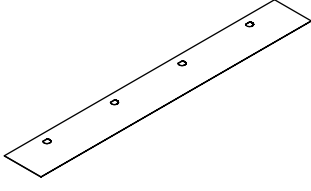
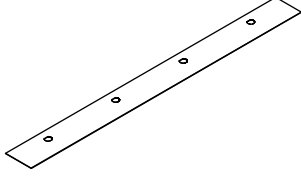
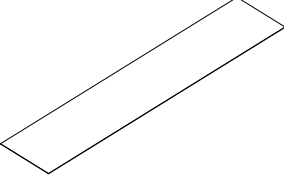



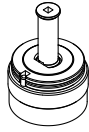









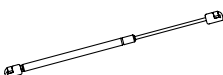





	Part	Part Number	Length/ Piece	Mill Finish	Price Each	
Channel Letter Raceways						
	Access Raceway	5" Narrow Access Raceway Front	1961N	24'-2"	\$154.23 <i>Cost per Foot</i> 6.38	N/A
		5" Narrow Access Raceway Back	1962N	24'-2"	193.30 <i>Cost per Foot</i> 8.00	N/A
	5" Narrow Access Raceway End Cap 5-9/16" x 3" x .090	5967N-5"	ea	N/A	\$15.28	
Hingeable Raceway		Flat Wall Mount Retro Body	2042	24'-6"	151.00 <i>Cost per Foot</i> 6.16	N/A
		Flat 1-1/2" Retainer	2052	24'-6"	168.23 <i>Cost per Foot</i> 6.87	N/A N/A
		Flat 2" Retainer	2047	24'-6"	191.55 <i>Cost per Foot</i> 7.82	N/A N/A
		Channel Letter Raceway U-Channel	1978	12'-2"	14.36 <i>Cost per Foot</i> 1.18	N/A
Components		Channel Letter Raceway Mounting Clip	1989	12'-0"	47.77 <i>Cost per Foot</i> 3.98	N/A
		Channel Letter Raceway Large Mounting Clip	1988	12'-0"	70.97 <i>Cost per Foot</i> 5.91	N/A
		Channel Letter Raceway 3" Mounting Clip	5989	ea	N/A	2.24
		Channel Letter Raceway 3" Large Mounting Clip	5988	ea	N/A	2.76
	Part	Part Number		Price Each		
Components		Corner Key 3-1/4" x 3-1/4" x .120 Stamped Aluminum	5210		\$1.55	
		3/4" Corner Key 3-1/16" x 3-1/16" x .125 Stamped Aluminum	5226		1.48	
		2 Piece Corner Key 1-3/8" x 1-3/8" x .200 Stamped Steel	5890		0.98	
		Flat 1-1/2" Retainer Corner Bracket Set	5213		6.54	
		Flat 2" Retainer Corner Bracket Set	5214		7.77	
		2Part Outer Frame Corner Angle 2" x 2" x 1/8" (3/8")	5975		2.20	
		Header/Reader Divider Angle 2" x 2" x 1/8" (3/4")	5980		1.70	
		Frame Corner Angle 1-3/4" x 1-3/4" x 1/4" (1-1/16")	5305		2.20	
		Divider Corner Angle 1-3/4" x 1-3/4" x 1/4" (1-1/16") w/Notches	5300		2.71	
		Menu Angle Assembly 2-1/2" x 2-1/2" x 1/4" (1/2")	5895		3.11	

Note: All dimensions are subject to the tolerance standards of the aluminum extrusion industry. Profile drawings are illustrative and rounded to the nearest 1/16".

Standard System Accessories

		Part	Part Number	Price Each
Components				
		1Part 2Part 12" D/F Body Corner Angle 1-3/4" x 1-3/4" x 1/4" - (9-5/16")	5977	\$11.47
		1Part 2Part 9" D/F Body Corner Angle 1-3/4" x 1-3/4" x 1/4" - (6-5/16")	5978	8.79
		1Part 2Part 6" D/F Body Corner Angle 1-3/4" x 1-3/4" x 1/4" - (3-3/4")	5985	6.83
		1Part 2Part 8" S/F Body Corner Angle 1-3/4" x 1-3/4" x 1/4" - (6-3/16")	5979	8.76
		1Part 2Part 6" S/F Body Corner Angle 1-3/4" x 1-3/4" x 1/4" - (4-3/16")	5981	7.31
		Menu 5" S/F Body Corner Angle 1-3/4" x 1-3/4" x 1/4" - (3-9/16")	5952	4.57
		1Part 2Part 12" D/F Body Ballast Pan 7-1/2" x 24" x .063	5970	37.55
		1Part 2Part 9" D/F Body Ballast Pan 4-5/8" x 24" x .063	5971	29.35
		1Part 2Part 8" S/F Body Ballast Pan 4-5/8" x 24" x .063	5971	29.35
		1Part 2Part 6" S/F Body Ballast Pan 3-1/2" x 24" x .063	5969	26.02
		1Part 2Part 12" D/F Body Raceway Cover 9-7/8" x 48" x .040 (white) Pre-Punched 12" O/C	5984-12"	35.62
		1Part 2Part 12" D/F Body Raceway Cover 9-7/8" x 36" x .040 (white) Pre-Punched 12" O/C	5983-12"	31.21
		1Part 2Part 12" D/F Body Raceway Cover 9-7/8" x 24" x .040 (white) Pre-Punched 12" O/C	5982-12"	23.44
		1Part 2Part 9" D/F Body Raceway Cover 6-7/8" x 48" x .040 (white) Pre-Punched 12" O/C	5984-9"	28.14
		1Part 2Part 9" D/F Body Raceway Cover 6-7/8" x 36" x .040 (white) Pre-Punched 12" O/C	5983-9"	25.91
		1Part 2Part 9" D/F Body Raceway Cover 6-7/8" x 24" x .040 (white) Pre-Punched 12" O/C	5982-9"	19.72
		1Part 2Part 8" S/F Body Raceway Cover 6-1/2" x 48" x .040 (white) Pre-Punched 12" O/C	5984-8"	26.94
		1Part 2Part 8" S/F Body Raceway Cover 6-1/2" x 36" x .040 (white) Pre-Punched 12" O/C	5983-8"	24.98
		1Part 2Part 8" S/F Body Raceway Cover 6-1/2" x 24" x .040 (white) Pre-Punched 12" O/C	5982-8"	19.08
		1Part 2Part 6" S/F Body Raceway Cover 4-3/4" x 48" x .040 (white) Pre-Punched 12" O/C	5984-6"	22.81
		1Part 2Part 6" S/F Body Raceway Cover 4-3/4" x 36" x .040 (white) Pre-Punched 12" O/C	5983-6"	21.30
		1Part 2Part 6" S/F Body Raceway Cover 4-3/4" x 24" x .040 (white) Pre-Punched 12" O/C	5982-6"	17.12
		1Part 2Part 12" D/F Body Raceway Cover 9-7/8" x 48" x .040 (white) Blank	5984B-12"	29.76
		1Part 2Part 9" D/F Body Raceway Cover 6-7/8" x 48" x .040 (white) Blank	5984B-9"	20.15
		1Part 2Part 8" S/F Body Raceway Cover 6-1/2" x 48" x .040 (white) Blank	5984B-8"	18.47
		1Part 2Part 6" S/F Body Raceway Cover 4-3/4" x 48" x .040 (white) Blank	5984B-6"	14.86

Standard System Accessories

Part		Part Number	Price Each
Components			
	D-Punch Assembly	5080	\$616.66
	Edge Lit LED 1/2 Round Cap 3-1/4" x 1-9/16" x .090	5905	9.04
	Edge Lit LED 1/4 Round Cap 2-3/16" x 1-9/16" x .090	5903	9.04
	Snap Frame Radius Cover Spring 1-1/16" x 1-1/16" x .010 Stainless Steel	5892	0.44/ea
	Snap Frame Flat Cover Spring 1" x 1" x .010 Stainless Steel	5893	0.44/ea
	2Part Lock For use with Parts #1942/#1960	5994	18.47
	2Part Large Lock For use with Parts #1941/#1959	5993	18.96
	2Part Lock Wrench For use with 2Part Lock Part #5994	5992	15.23
	2Part Hinge 1-1/16" x 96" x .060 Aluminum Hinge	5996 *5996P	30.00 54.00
	2Part Large Hinge 1-1/2" x 96" x .063 Aluminum Hinge	5997 *5997P	42.86 67.18
	Gas Support Included: (2) Gas Supports/Ball Stud Mounting Brackets (4) 10mm Ball Studs Screws for mechanical fastening Designed for SignComp Large Vandal only. Not recommended with other systems. Call Customer Service for specific gas support size and poundage.	5934-Kit	110.61
Hardware			
	 2Part 6" D/F Retainer Screw Pre-drill and countersink 1/8" holes 12" o/c #8 x 1/2" stainless steel square/phillips drive countersink screw - Type A	5168 5168P	14.00/100 36.00/100
	2Part Retainer Screw	5290	16.00/100
	2Part Extended Retainer Screw	5290P	36.00/100
	Raceway Cover Screw Pre-drill 1/8" holes 12" o/c		
	Raceway End Cap Screw #8 x 1/2" steel zinc square/phillips drive pan head screw - Type A		
	Menu Hinge Attachment Screw Pre-drill and countersink 1/8" holes 2" o/c #8 x 5/16" stainless steel phillips countersink screw - Type B	5193	36.00/100
	1Part 2Part Corner Angle Screw Pre-drill 5/32" holes four (4) per body corner	5218	38.00/100
	Divider Angle Screw Two (2) per end #10 x 1/2" stainless steel square/phillips drive pan head screw - Type AB		
	2Part Extended Retainer Corner Screw	5241	12.00/100
	Menu Clip Screw Pre-drill and countersink 1/8" holes one (1) per corner #8 x 3/4" stainless steel square/phillips drive countersink screw - Type A	5241P	30.00/100
	Wall Frame Corner Screw Pre-drill #6 countersink hole one (1) per corner #6 x 3/4" stainless steel square/phillips drive countersink screw - Type A	5245	12.00/100
	2Part Outer Frame Corner Angle Screw Pre-drill and countersink 1/8" holes two (2) per corner angle #8 x 3/8" stainless steel square/phillips drive countersink screw - Type A	5990	12.00/100
	LED Cap Screw #6 x 3/8" stainless steel square/phillips drive countersink screw - Type A	5940	11.00/100
	LED Spring Pin Drill 5/64" holes through face 12" o/c 3/32" x 5/8" Stainless Steel	5945	12.00/100

*Pre-painted Dark Bronze Anodized

Note: All dimensions are subject to the tolerance standards of the aluminum extrusion industry. Profile drawings are illustrative and rounded to the nearest 1/16".

Standard System Configurations

Bodies

1Part 12" Double Face Body
#1924

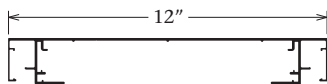

1Part 9" Double Face Body
#1923

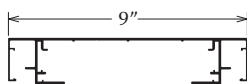

1Part 6" Double Face Body
#1931

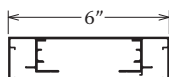

1Part 8" Single Face Body
#1922

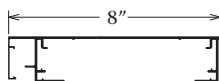

1Part 6" Single Face Body
#1921

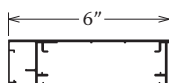

Removeable Retainers

2Part Retainer

#1944 or #1954

2Part 12" Double Face Body
#1929

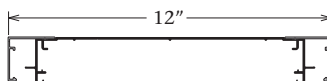

2Part 9" Double Face Body
#1928

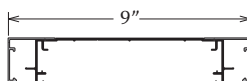

2Part 6" Double Face Body
#1936
(Only integrates with Part #1954)

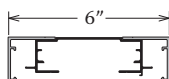

2Part 8" Single Face Body
#1927

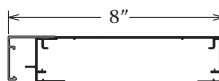

2Part 6" Single Face Body
#1926

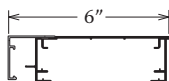

Standard System Configurations

Removeable Retainers

2Part Extended Retainer

#1940

2Part Extended Frame & Cover

#1955 and #1944

2Part 12" Double Face Body
#1929

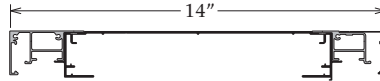

2Part 9" Double Face Body
#1928

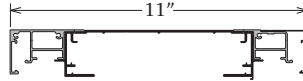

2Part 6" Double Face Body
#1936

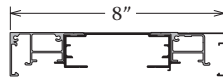

2Part 8" Single Face Body
#1927

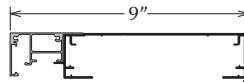

2Part 6" Single Face Body
#1926

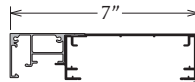

2Part Large Extended Retainer

#1939

2Part 12" Double Face Body
#1929

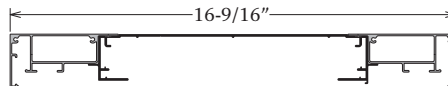

2Part 9" Double Face Body
#1928

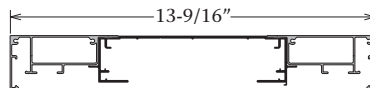

2Part 6" Double Face Body
#1936

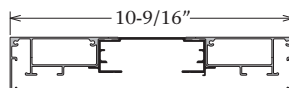

2Part 8" Single Face Body
#1927

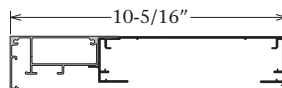

2Part 6" Single Face Body
#1926

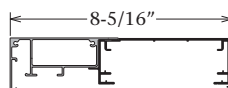

Note: All dimensions are subject to the tolerance standards of the aluminum extrusion industry. Profile drawings are illustrative and rounded to the nearest 1/16".

Standard System Configurations

Vandal Retainers

2Part Inner Frame

#1960

2Part Outer Frame

#1942

2Part 12" Double Face Body

#1929

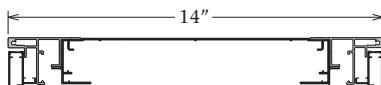

2Part 9" Double Face Body

#1928

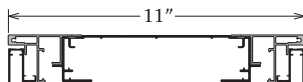

2Part 6" Double Face Body

#1936

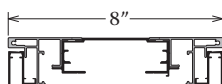

2Part 8" Single Face Body

#1927

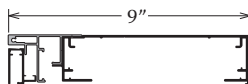

2Part 6" Single Face Body

#1926

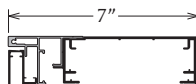

2Part Large Inner Frame

#1959

2Part Large Outer Frame

#1941

2Part 12" Double Face Body

#1929

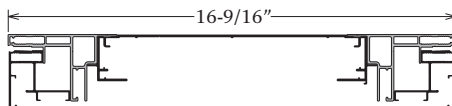

2Part 9" Double Face Body

#1928

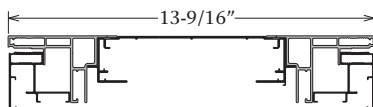

2Part 6" Double Face Body

#1936

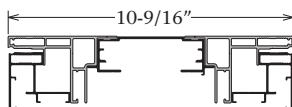

2Part 8" Single Face Body

#1927

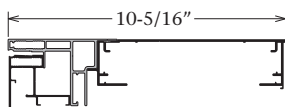

2Part 6" Single Face Body

#1926

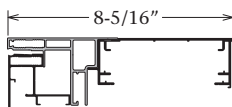

Standard System Configurations

Vandal Retainers with Headers

2Part Vandal System

#1960 and #1942

2Part Extended Retainer

#1940

2Part 12" Double Face Body

#1929

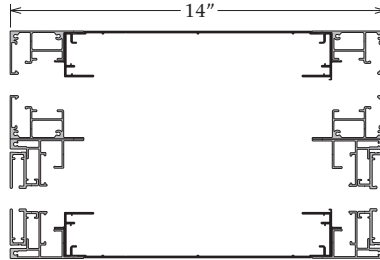

2Part 9" Double Face Body

#1928

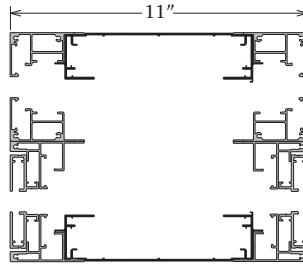

2Part 6" Double Face Body

#1936

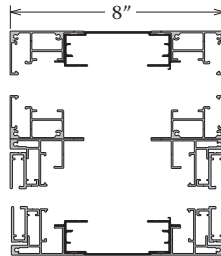

2Part 8" Single Face Body

#1927

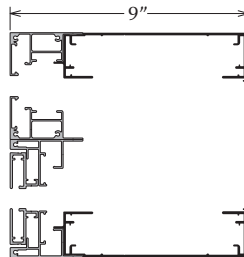

2Part 6" Single Face Body

#1926

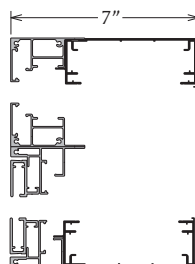

Note: All dimensions are subject to the tolerance standards of the aluminum extrusion industry. Profile drawings are illustrative and rounded to the nearest 1/16".

Standard System Configurations

Vandal Retainers with Headers

2Part Large Vandal System

#1959 and #1941

2Part Large Extended Retainer

#1939

2Part 12" Double Face Body

#1929

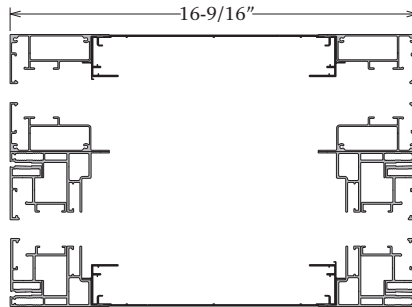

2Part 9" Double Face Body

#1928

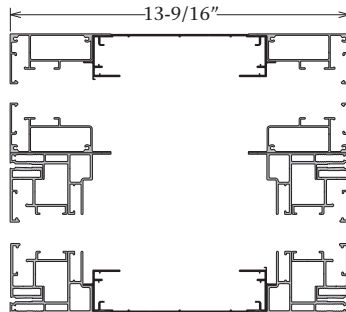

2Part 6" Double Face Body

#1936

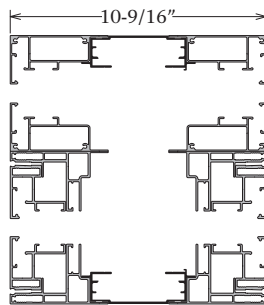

2Part 8" Single Face Body

#1927

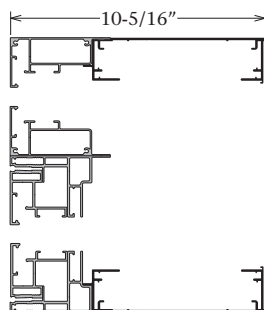

2Part 6" Single Face Body

#1926

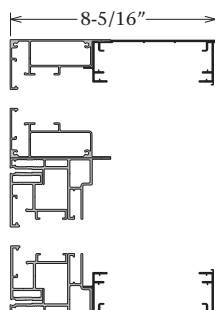

Standard System Specifications

Sign Cabinet Bodies

2Part 12" Double Face Body
Part #1929

2Part Retainer
Part #1944

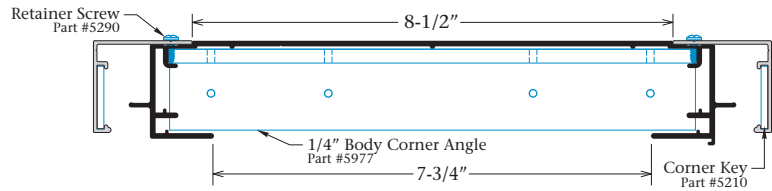

1Part 12" Double Face Body
Part #1924

Note: It is recommended to cut bodies and retainers 1-3/4" over nominal T12 or T8 lamp length to utilize .040 flat aluminum raceway covers.

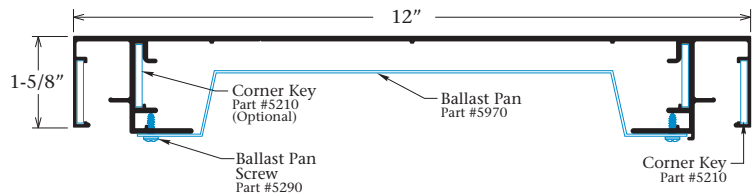

2Part 9" Double Face Body
Part #1928

2Part Retainer
Part #1944

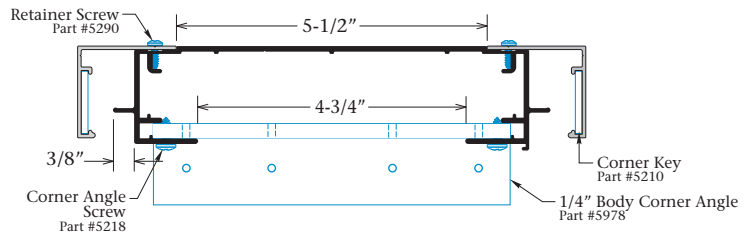

1Part 9" Double Face Body
Part #1923

Note: It is recommended to cut bodies and retainers 1-3/4" over nominal T12 or T8 lamp length to utilize .040 flat aluminum raceway covers.

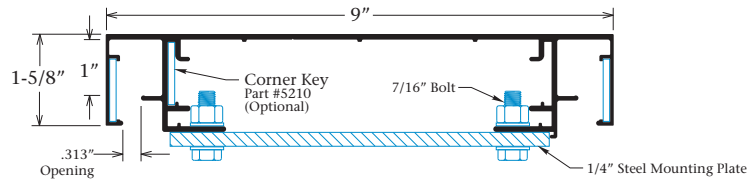

2Part 6" Double Face Body
Part #1936

2Part 6" Double Face Retainer
Part #1954

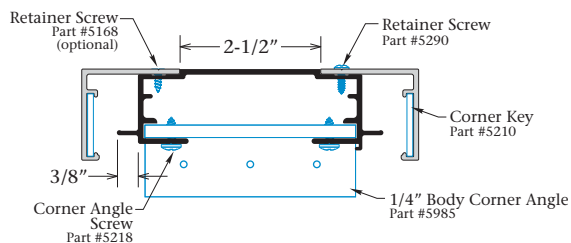

1Part 6" Double Face Body
Part #1931

Note: It is recommended to cut bodies and retainers 1" over nominal T12 or T8 lamp length to utilize .040 flat aluminum raceway covers.

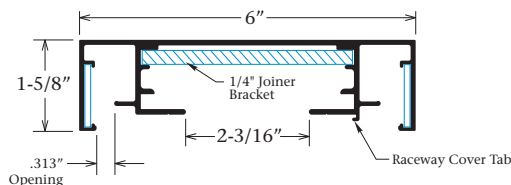

Note: See page 77 for all body components.

Note: Attach the 1/4" steel mounting plate above the inner body flanges to increase structural connection.

Standard System Specifications

Sign Cabinet Bodies

2Part 8" Single Face Body
Part #1927

2Part Retainer
Part #1944

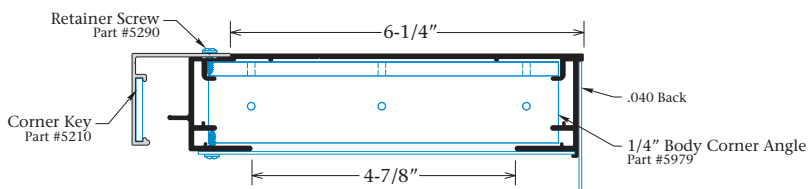

1Part 8" Single Face Body
Part #1922

Note: It is recommended to cut bodies and retainers 1-3/4" over nominal T12 or T8 lamp length to utilize .040 flat aluminum raceway covers.

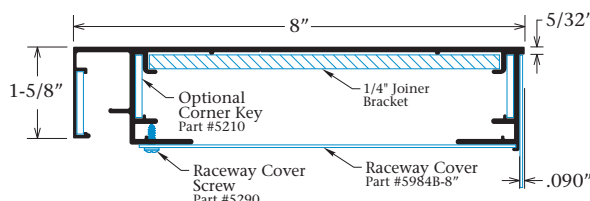

2Part 6" Single Face Body
Part #1926

2Part Retainer
Part #1944

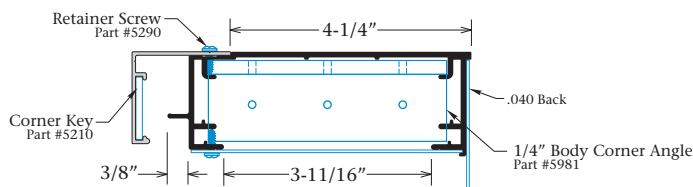

1Part 6" Single Face Body
Part #1921

Note: It is recommended to cut bodies and retainers 1-3/4" over nominal T12 or T8 lamp length to utilize .040 flat aluminum raceway covers.

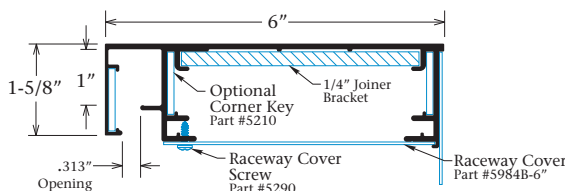

Note: See page 77 for all body components.

Retainers

2Part Retainer
Part #1944

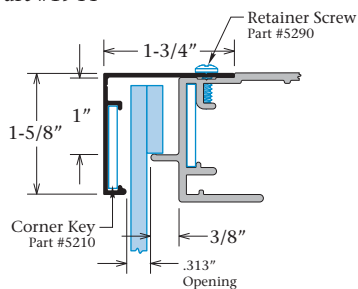

2Part 6" Double Face Retainer
Part #1954

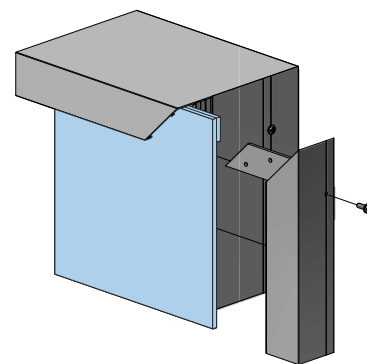
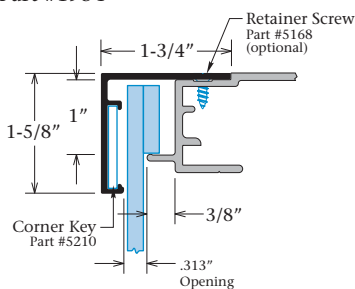

2Part Extended Retainer
Part #1940

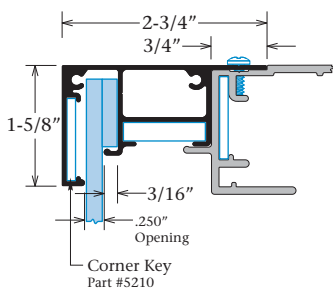

2Part Extended Frame/2Part Retainer
Part #1955

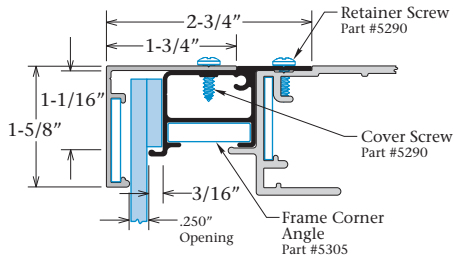

2Part Large Extended Retainer
Part #1939

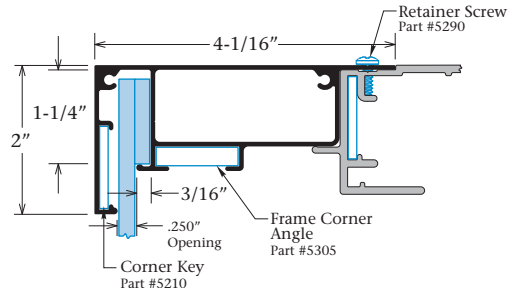

Standard System Specifications

Dividers

2Part Divider
Part #1905

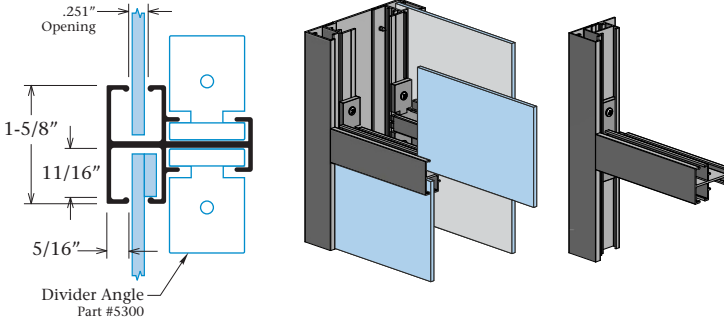

Standard Dividers

1-1/2" Divider
Part #1910

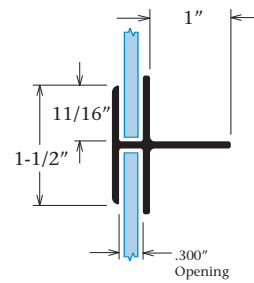

2-1/2" Divider
Part #1920

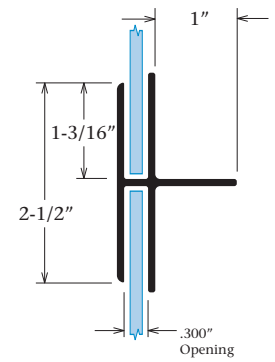

Vandal Systems with Headers

2Part Extended Retainer
Part #1940

2Part Vandal System
Parts #1960 and Part #1942

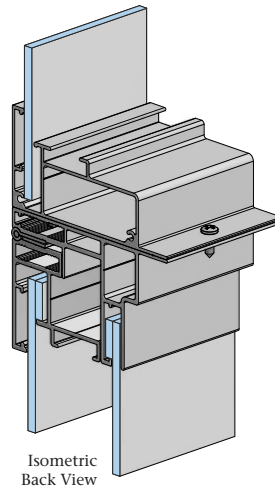
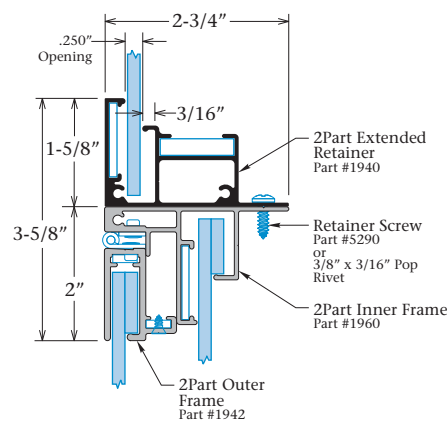

2Part Large Extended Retainer
Part #1939

2Part Large Vandal System
Parts #1959 and Part #1941

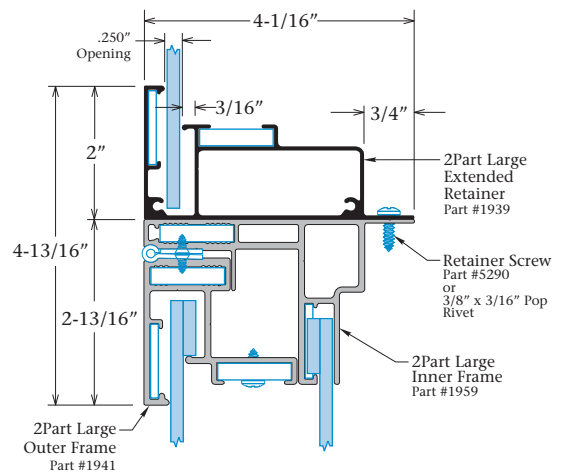

STANDARD

Vandal to Vandal Systems (Menu Boards)

2Part Vandal System
Parts #1960 and Part #1942

2Part Vandal System
Parts #1960 and Part #1942

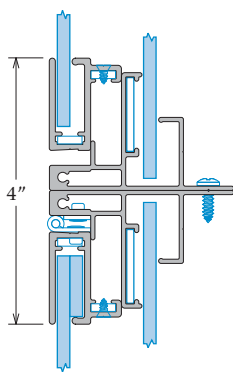

2Part Large Vandal System
Parts #1959 and Part #1941

2Part Large Vandal System
Parts #1959 and Part #1941

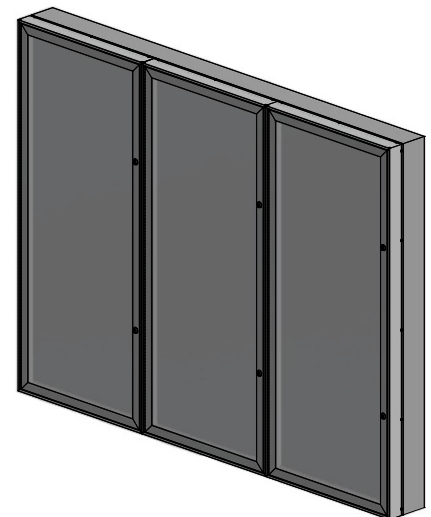
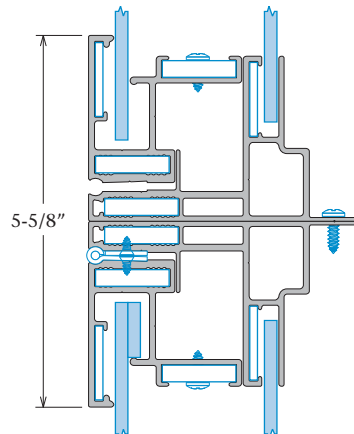

Note: It is recommended to use safety chains and prop-bars on hingeable faces.

Note: All dimensions are subject to the tolerance standards of the aluminum extrusion industry. Profile drawings are illustrative and rounded to the nearest 1/16".

Standard System Specifications

Vandal Systems

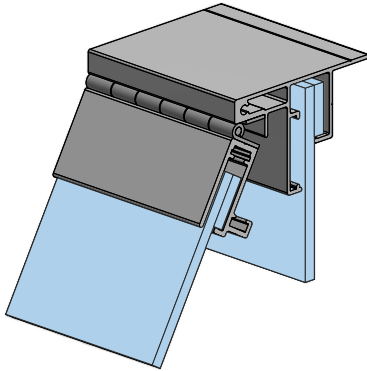

2Part Inner Frame
Part #1960

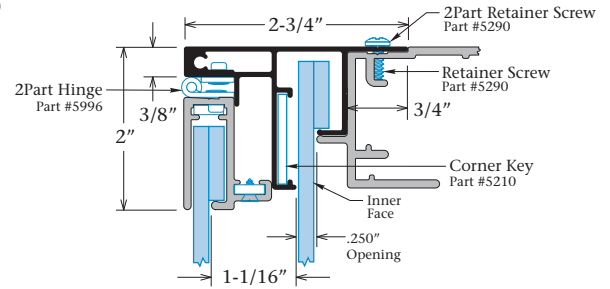

2Part Outer Frame with 2Part Lock
Part #1942

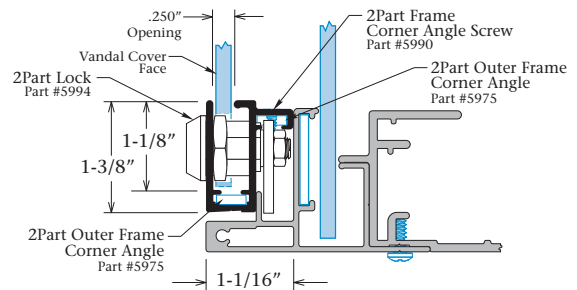

2Part Large Inner Frame
Part #1959

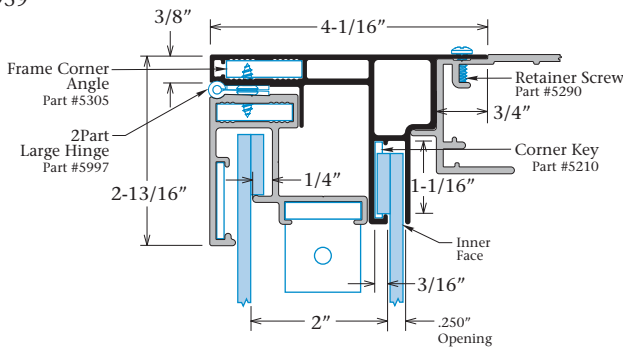

2Part Large Outer Frame with 2Part Large Lock
Part #1941

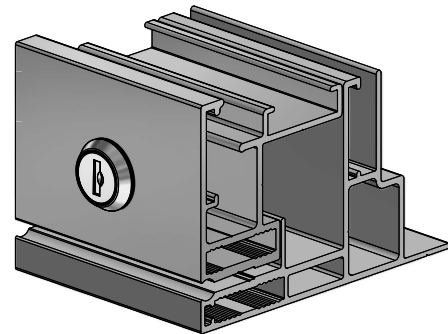
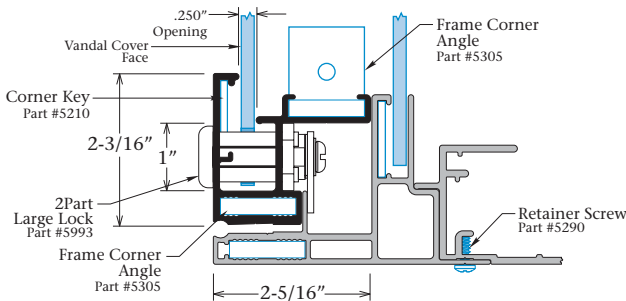

2Part Large Vandal System with Gas Support

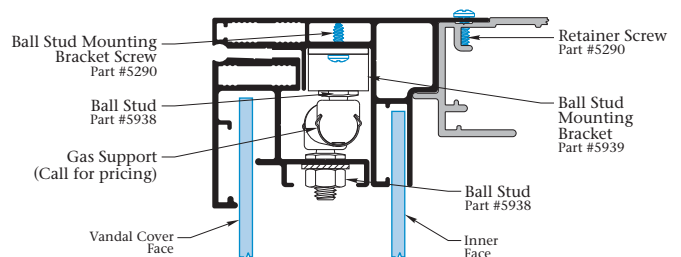

Note:

The **Inner Frame** retains the inner face which is typically a translucent white face for changeable copy systems.

The **Outer Frame** retains the vandal cover or outer face which is typically a clear lens.

Call Customer Service at 877-784-0405 for specific gas support size and poundage.

Note: It is recommended to use safety chains and prop-bars on hingeable faces.

Standard System Specifications

Menu Board System

Menu 5" Single Face Body with Menu Door Frame - Internal Divider View
 Part #1802 Part #1804 Part #1807

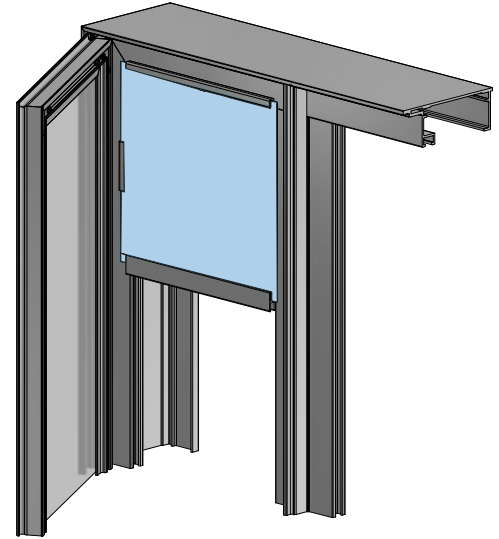
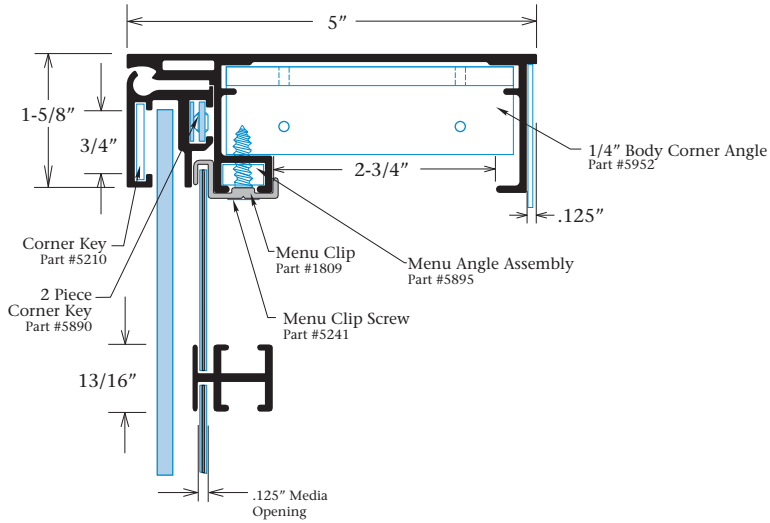

Menu External Divider View
 Part #1806

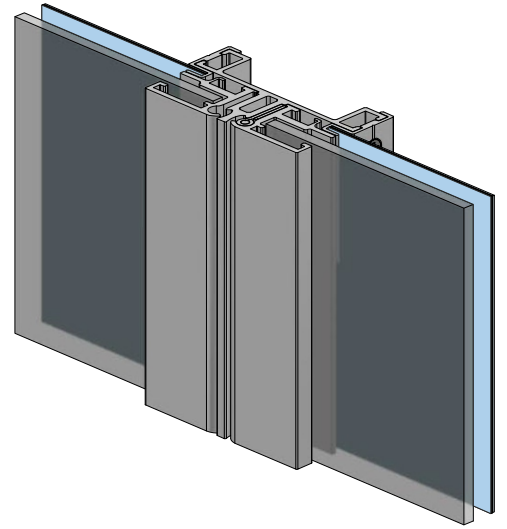
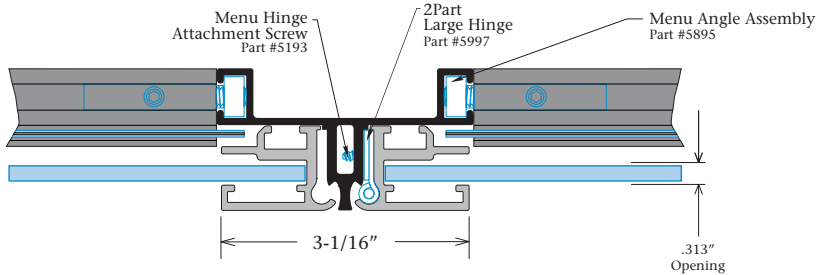

Configuration Examples

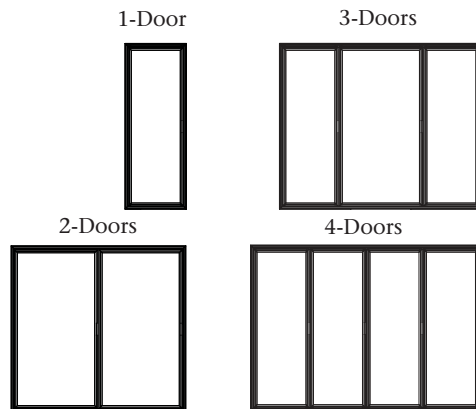
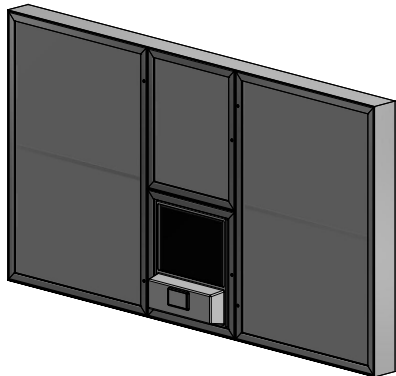

Note: Call Customer Service at 877-784-0405 for custom configurations.

Note: It is recommended to use safety chains and prop-bars on hingeable faces.

Note: All dimensions are subject to the tolerance standards of the aluminum extrusion industry. Profile drawings are illustrative and rounded to the nearest 1/16".

Standard System Specifications

Edge Lit

Edge Lit LED 1/2 Round
Part #1995

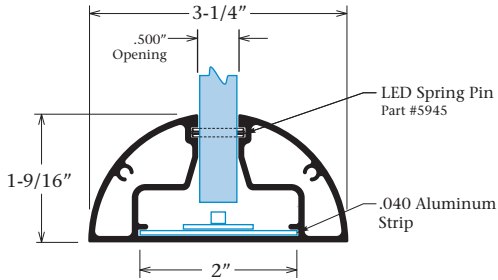

Edge Lit LED 1/4 Round
Part #1996

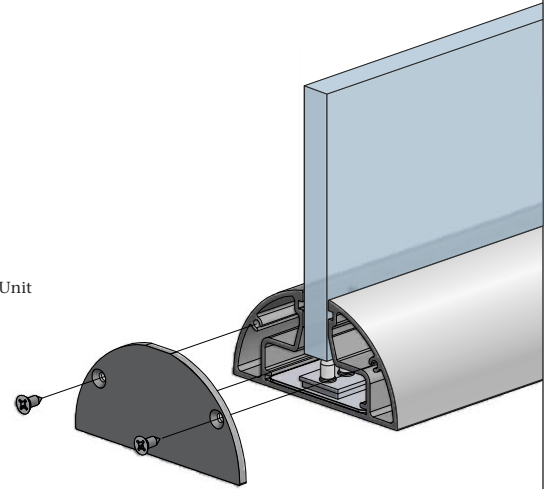
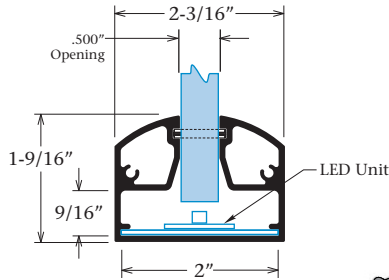

Snap Frames

Snap Frame
Part #1899
Snap Frame
Flat Cover
Part #1895

Snap Frame
Part #1899
Snap Frame
Radius Cover
Part #1896

Large Snap Frame
Part #1898
Snap Frame
Flat Cover
Part #1895

Large Snap Frame
Part #1898
Snap Frame
Radius Cover
Part #1896

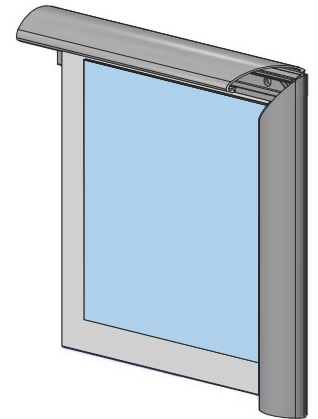
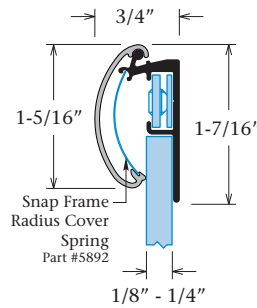
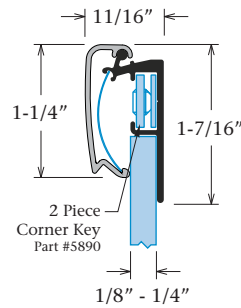
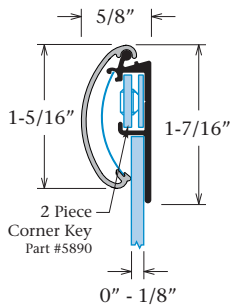
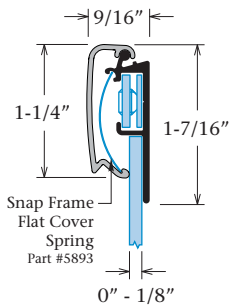

Snap Frame with Bleed Body Configurations

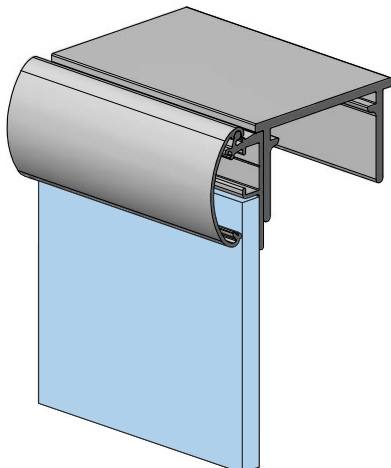

Series 2 Bleed Body
Part #1120

Series 3 Bleed Body
Part #1270

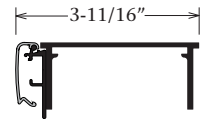
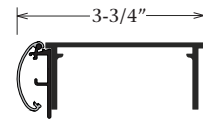
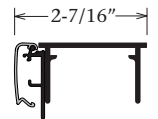
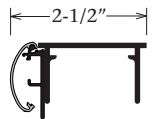

Part #1898/#1896
Depth 2-11/16"

Part #1898/#1895
Depth 2-5/8"

Part #1898/#1896
Depth 3-15/16"

Part #1898/#1895
Depth 3-7/8"

Standard System Specifications

Wall Frames

3/4" Wall Frame
Part #1948

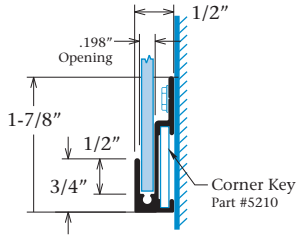

1-3/8" Wall Frame
Part #1949

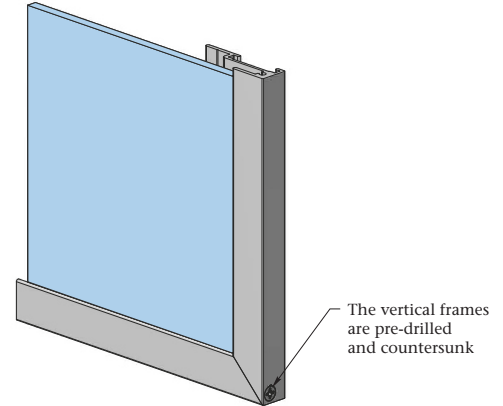
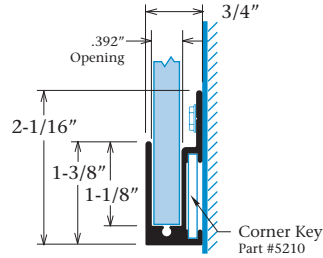

Moldings

1" H-Molding
Part #1945

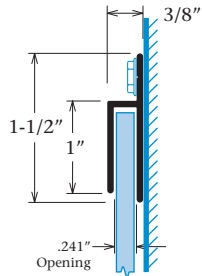

1" Z-Molding
Part #1946

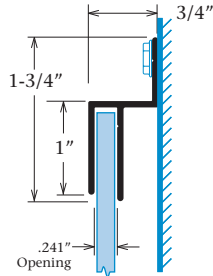

1.5" Z-Molding
Part #1947

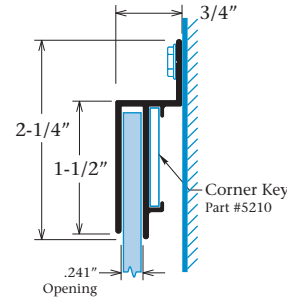

1-3/8" L-Molding
Part #1943

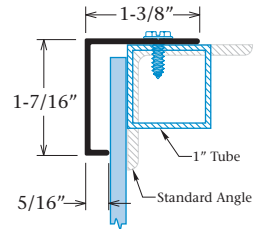

Socket Raceways

Large Socket Raceway
Part #1983
Socket Raceway Cover
Part #1987

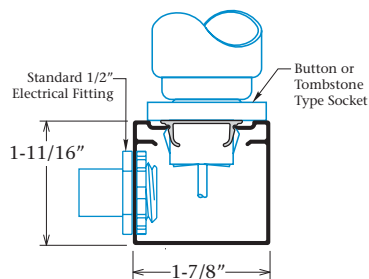

Socket Raceway
Part #1984
Socket Raceway Cover
Part #1987

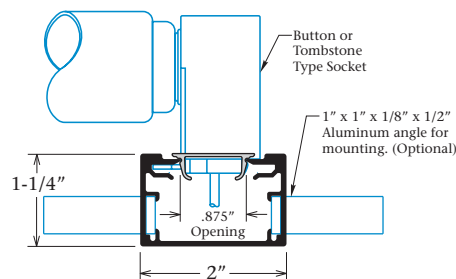

Socket Raceway II
Part #1985
Socket Raceway Cover
Part #1987

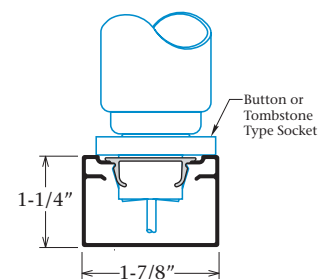

Ballast / Power Supply Raceway

Ballast Raceway
Part #1969

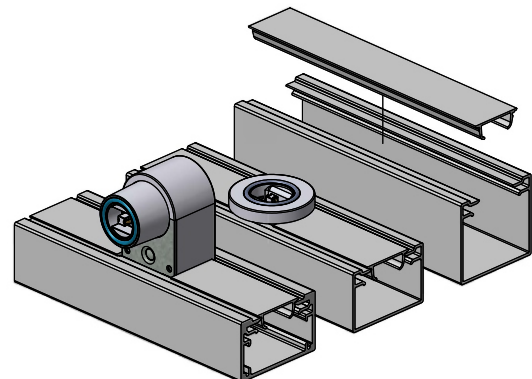
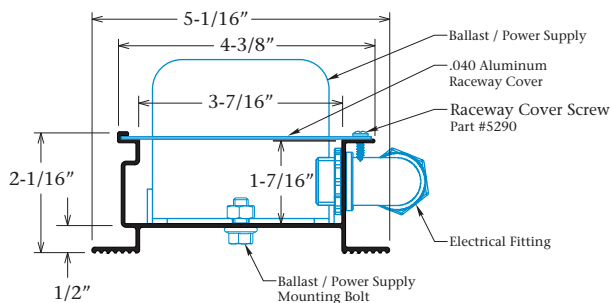

Note: All dimensions are subject to the tolerance standards of the aluminum extrusion industry. Profile drawings are illustrative and rounded to the nearest 1/16".

Standard System Specifications

Channel Letter Raceways

1 Piece 8" Channel Letter Raceway w/ Raceway Cover
Part #1980 Part #1986

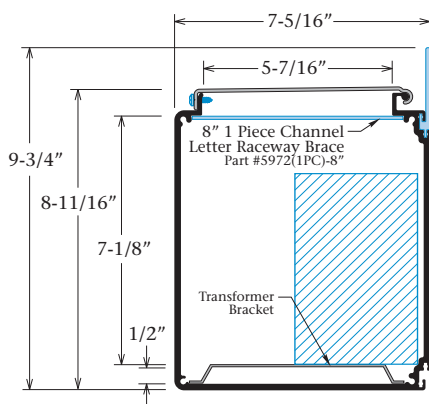

2 Piece 8" Channel Letter Raceway w/ Raceway Cover
Part #1981 & #1982 Part #1986

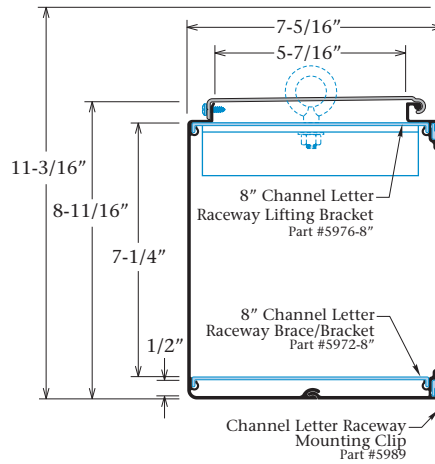

2 Piece 8" Narrow Channel Letter Raceway w/ Raceway Cover
Part #1981 & #1982N Part #1986N

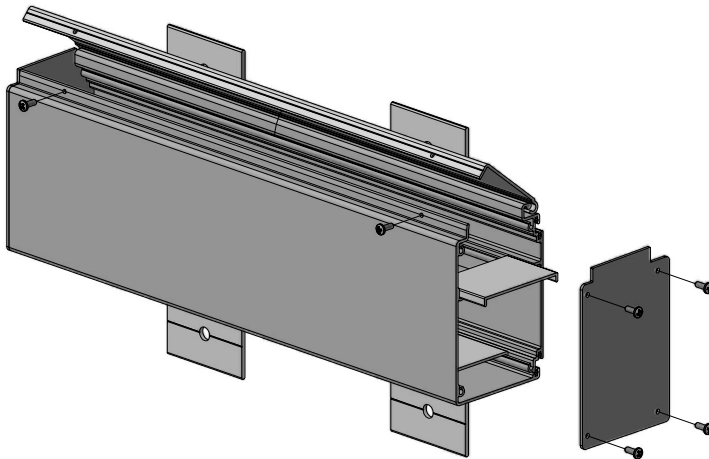
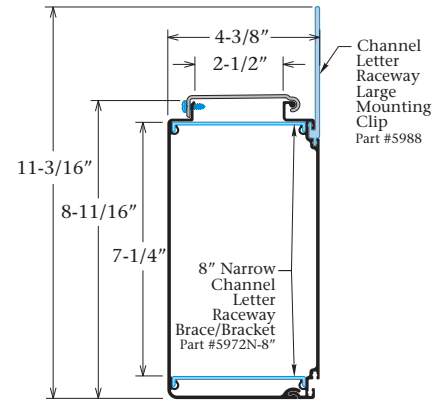

1 Piece 5" Narrow Channel Letter Raceway w/ Raceway Cover
Part #1970N Part #1976N

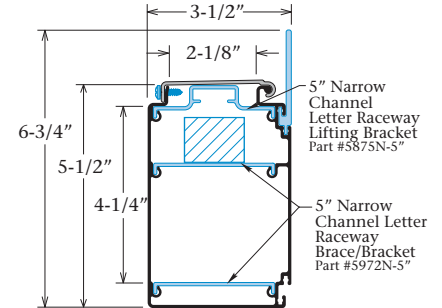

2 Piece 5" Channel Letter Raceway w/ Raceway Cover
Part #1971 & #1972 Part #1976

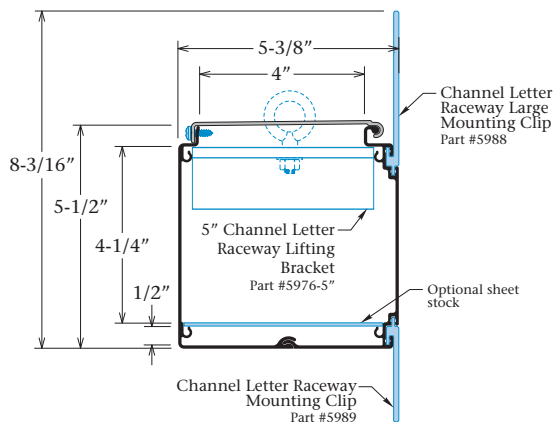

2 Piece 5" Narrow Channel Letter Raceway w/ Raceway Cover
Part #1971 & #1972N Part #1976N

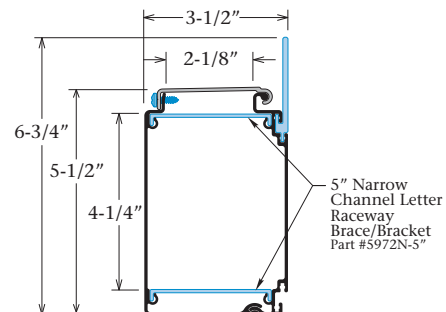

Standard System Specifications

Access Raceway

2 Piece 5" Narrow Access Raceway
Part #1961N & #1962N

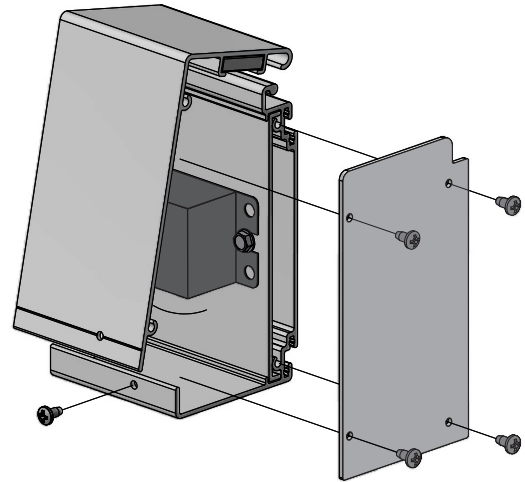
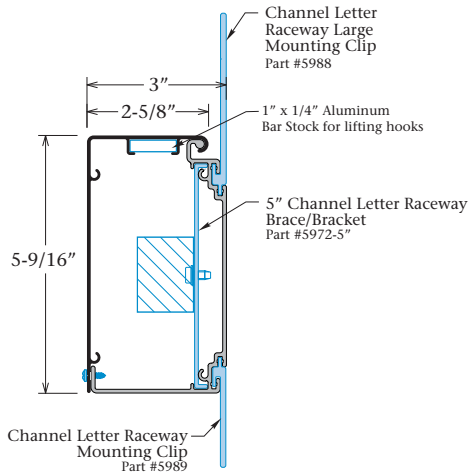

Removable End Caps for access to power supply bracket.

Channel Letter Hingeable System

Flat Wall Mount Retro Body
Part #2042

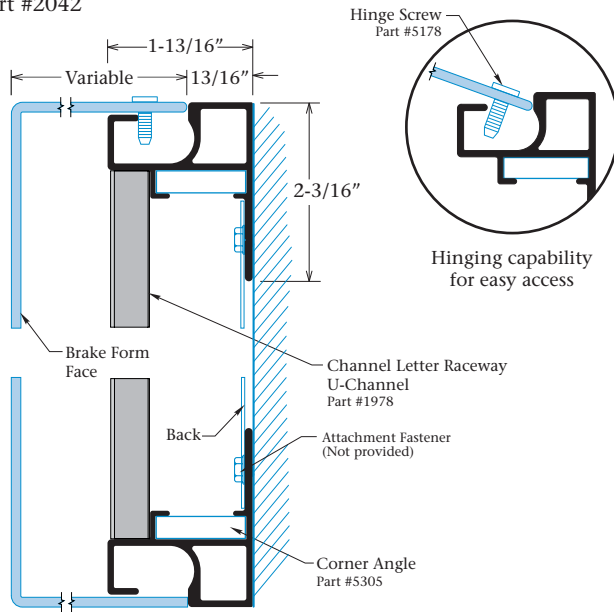

Hinging capability for easy access

Channel Letter Raceway U-Channel
Part #1978

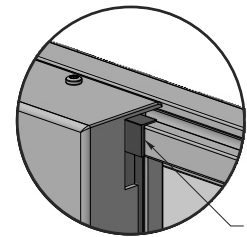
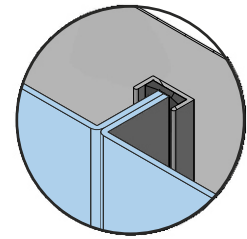
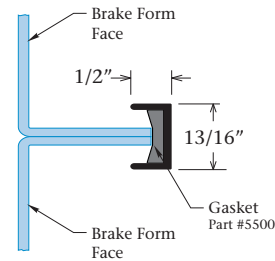

Gasket Part #5500

Accommodates multiple panels for larger raceway applications.

Optional Retainers

Flat 1-1/2" Retainer
Part #2052

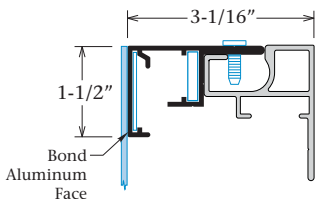



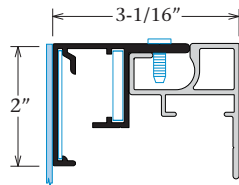

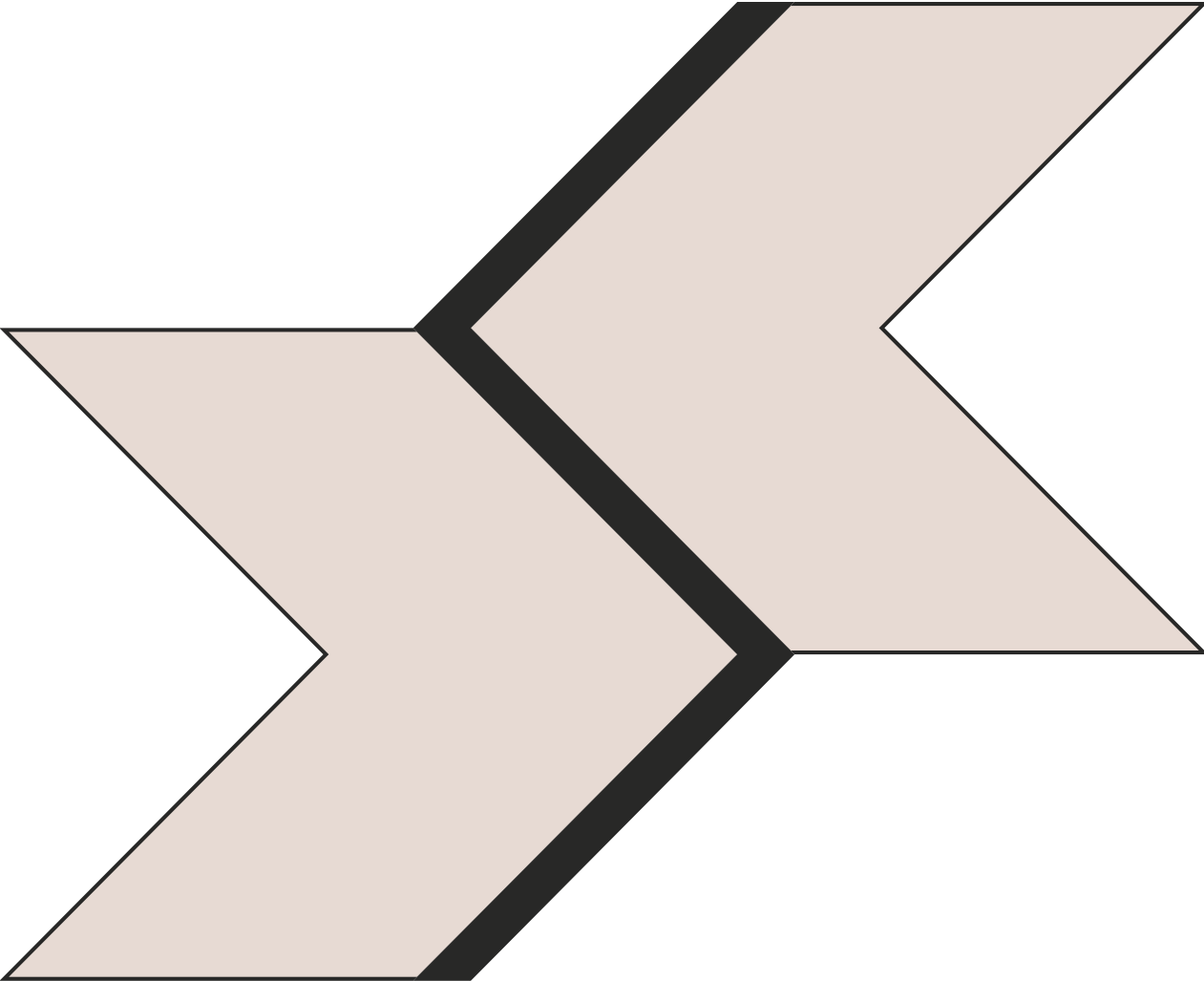
Flat 2" Retainer
Part #2047



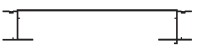
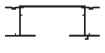







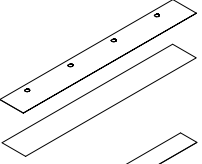

Extrusions Priced by the Length

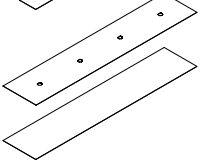
Part	Part Number	Length	Mill Finish	Dk. Bronze
Sign Cabinet Fillers				
 Large Double Face Filler	2032	24' 6"	\$277.79 <i>Cost per Foot</i> 11.34	\$370.98 15.14
 Medium Double Face Filler	2036	24' 6"	187.89 <i>Cost per Foot</i> 7.67	251.18 10.25
 Single Face Filler	2034	24' 6"	188.97 <i>Cost per Foot</i> 7.71	252.85 10.32
Moldings				
 Econo Molding	2056	24' 6"	38.77 <i>Cost per Foot</i> 1.58	52.11 2.13
 Extended Econo Molding	2058	24' 6"	120.09 <i>Cost per Foot</i> 4.90	158.02 6.45
Divider				
 1-5/16" Econo Divider	2140	24' 0"	87.55 <i>Cost per Foot</i> 3.65	120.08 5.00

EconoComp System Accessories

Part	Part Number	Price Each	
Components			
 Corner Key 3-1/4" x 3-1/4" x .120 Stamped Aluminum	5210	\$1.55	
 Divider Angle for Econo Molding 1" x 1" x 1/8" (1/2")	5325	1.83	
 Extended Divider Angle for Extended Econo Molding 1" x 1" x 1/8" (2-1/4")	5335	2.45	
	Single Face Filler Raceway Cover 5-1/8" x 48" x .040" (white) Pre-Punched 7" centers	5082	24.88
	Pre-Punched 10" centers	5083	24.88
	Blank	5084	14.22
	Medium Double Filler Raceway Cover 3" x 48" x .040" (white) Blank	5085	9.26
		Large Double Filler Raceway Cover 6-1/2" x 48" x .040" (white) Pre-Punched 7" centers	5086
Pre-Punched 10" centers		5087	31.98
Blank		5088	18.47
Hardware			
 	Corner Key Screw Four (4) per corner key Divider Angle Screw Three (3) per end #8 x 1/2" coated hex washer self drilling/tapping screw - Type A	5217	34.00/100
 	Molding Screw Pre-drill 1/8" holes 12" o/c #8 x 1/2" steel zinc square/phillips drive pan head screw - Type A	5290 5290P	16.00/100 36.00/100

Extrusions available in full lengths and kits.

Note: All dimensions are subject to the tolerance standards of the aluminum extrusion industry. Profile drawings are illustrative and rounded to the nearest 1/16".

EconoComp System Configurations

Sign Cabinet Fillers with Moldings

Econo Molding
#2056

Large Double Face Filler
#2032

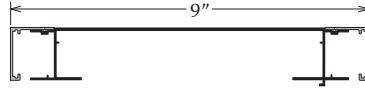

Medium Double Face Filler
#2036

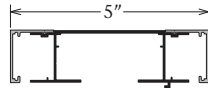

Single Face Filler
#2034

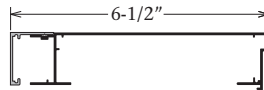

Extended Econo Molding
#2058

Large Double Face Filler
#2032

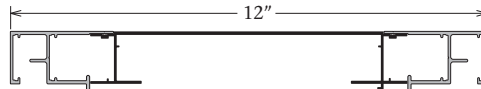

Medium Double Face Filler
#2036

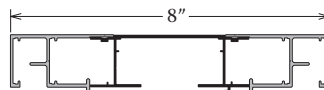

Single Face Filler
#2034

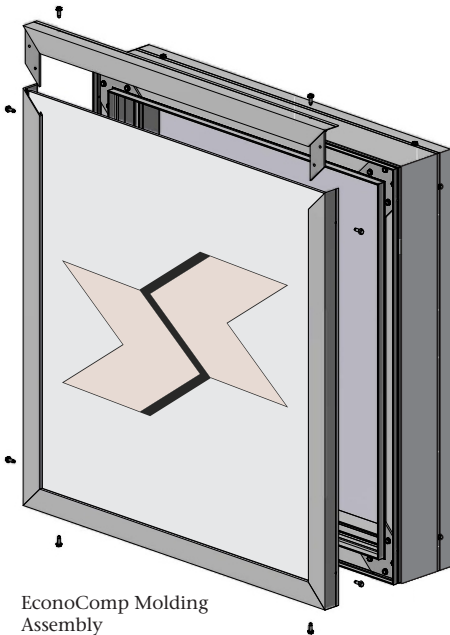
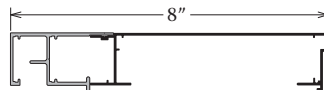

EconoComp Molding Assembly

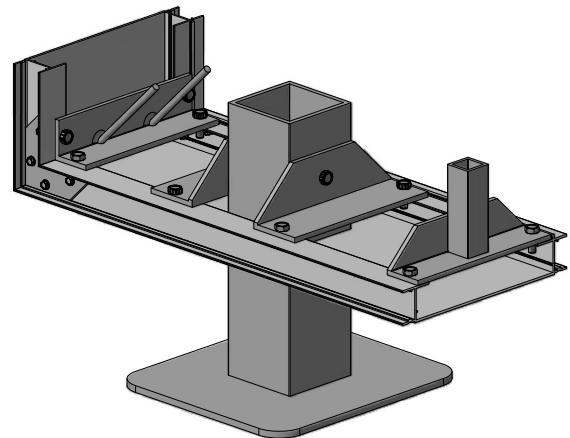

EconoComp System Conceptual Structural Support

EconoComp System Specifications

Sign Cabinet Fillers (Bodies)

Large Double Face Filler

Part #2032

Econo Molding

Part #2056

Note: It is recommended to cut fillers and moldings 1" over nominal T12 or T8 lamp length to utilize .040 flat aluminum raceway covers.

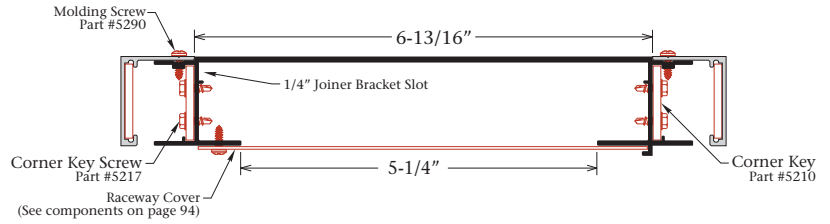

Medium Double Face Filler

Part #2036

Extended Econo Molding

Part #2058

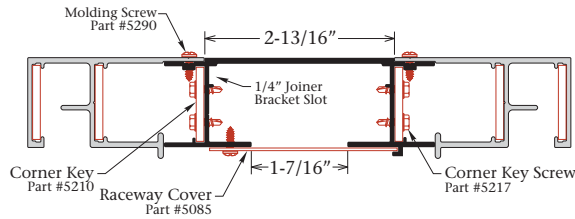

Single Face Filler

Part #2034

Econo Molding

Part #2056

Note: It is recommended to cut fillers and moldings 1" over nominal T12 or T8 lamp length to utilize .040 flat aluminum raceway covers.

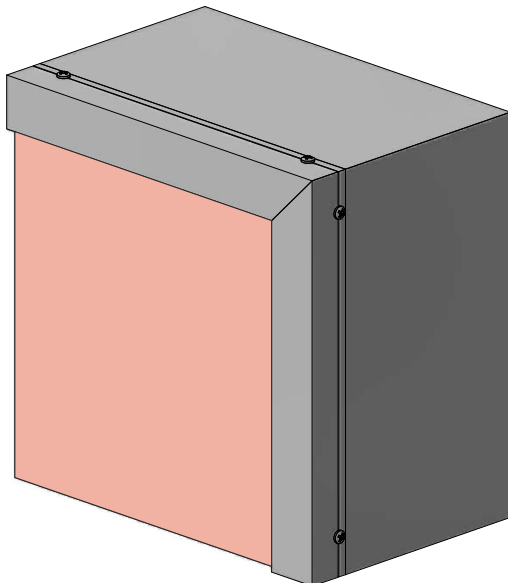
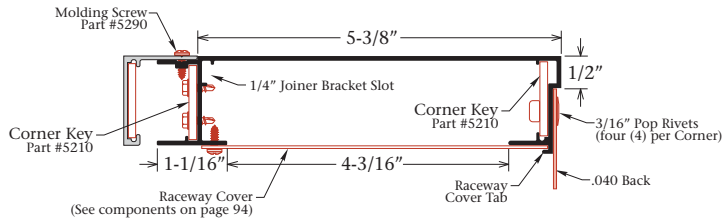

Single Face Filler (back)

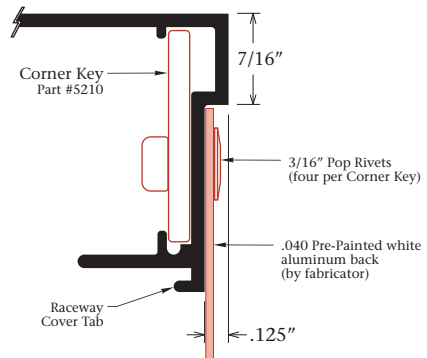

Note: See page 94 for all body components.

Note: All dimensions are subject to the tolerance standards of the aluminum extrusion industry. Profile drawings are illustrative and rounded to the nearest 1/16".

EconoComp System Specifications

Moldings (Retainers)

Econo Molding Part #2056

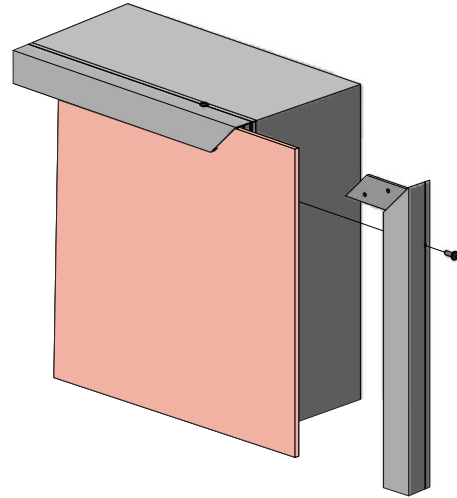
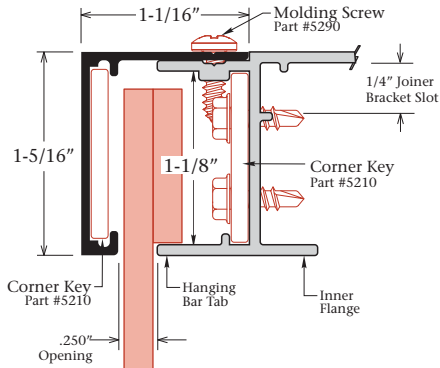

Extended Econo Molding Part #2058

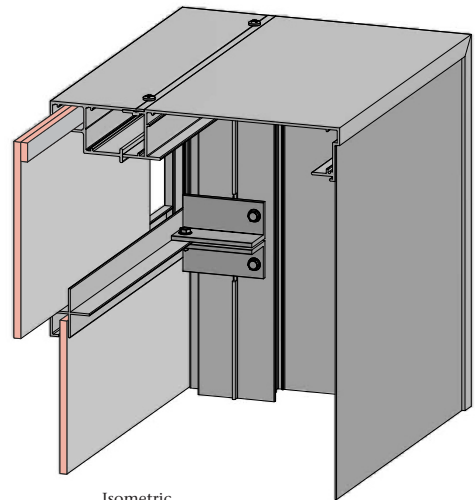
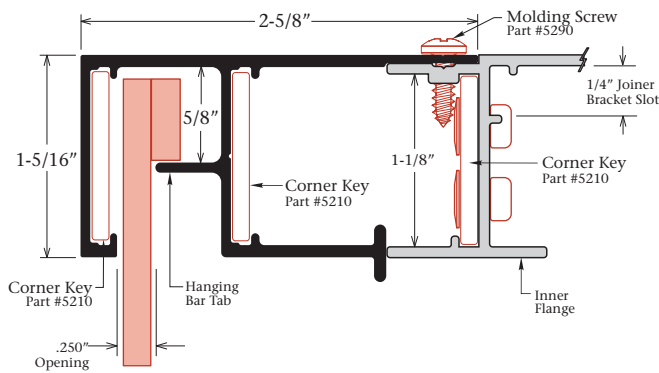

Isometric
Back View

Divider

1-5/16" Econo Divider Part #2140

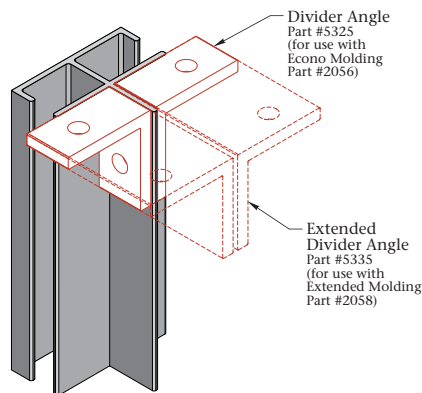
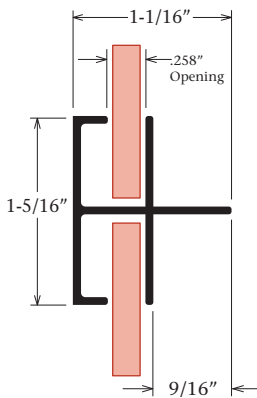

Divider Angle
Part #5325
(for use with
Econo Molding
Part #2056)

Extended
Divider Angle
Part #5335
(for use with
Extended Molding
Part #2058)

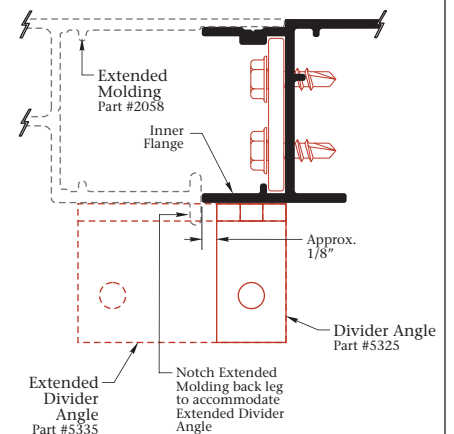

Note: 1-5/16" Econo Divider is engineered for use with the Econo Molding. For use with the Extended Econo Molding, attach the Econo Divider to the Inner Flange using the Extended Divider Angle, part #5335 as noted and shown above.

Cutting Services

Commercial - Architectural - Standard - EconoComp

Kerf-cuts

Note: This cutting process is best suited for retro frames, however it can also work well with retainers, bodies and more.

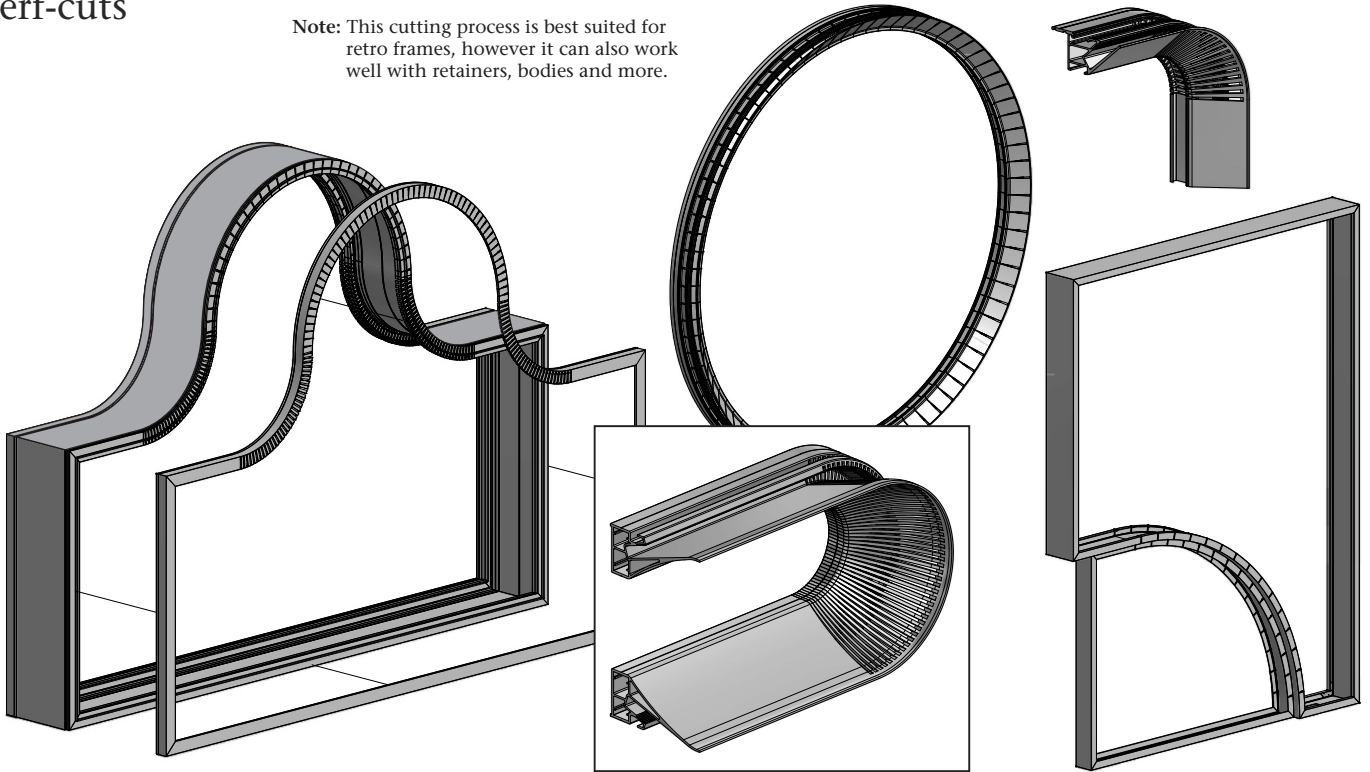

A series of relief cuts are placed in the extrusion to form a custom shape. Add straps or weld to create and maintain the shape (not provided by SignComp). Offered in pre-cut lengths or pre-cut kits.

Special Miters

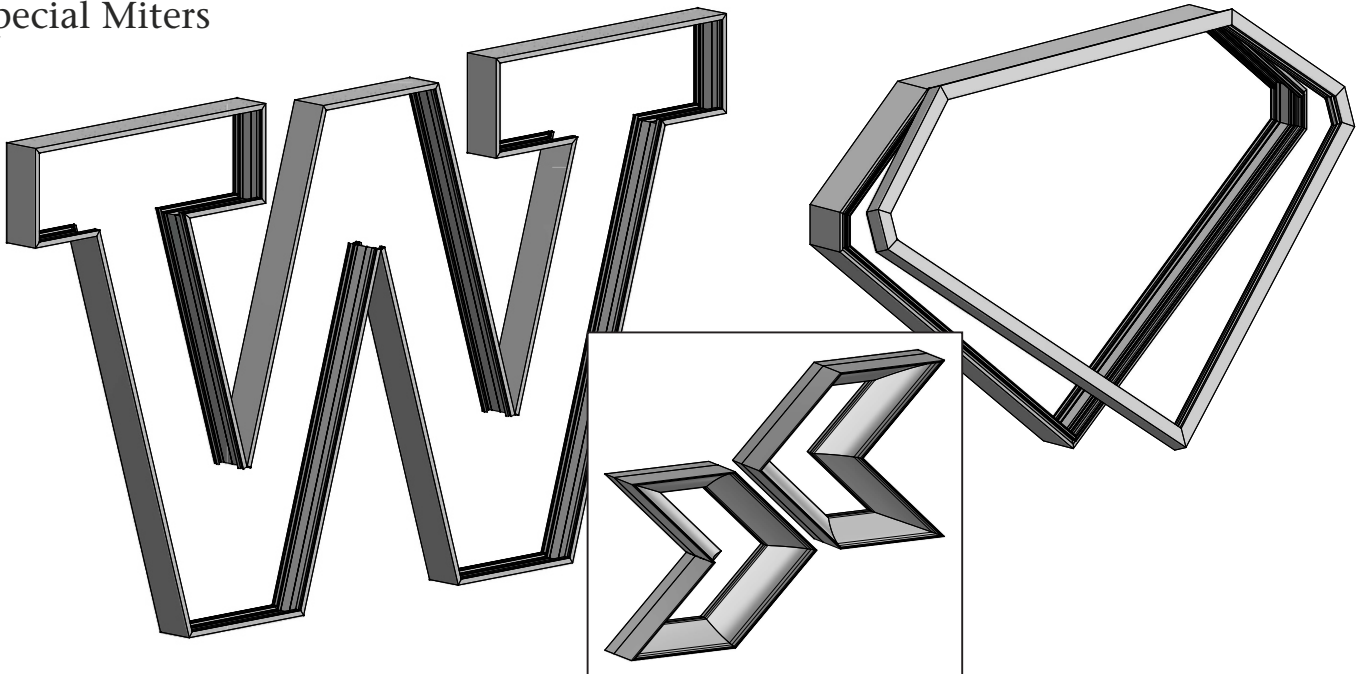

Pre-cut kits are available for custom angles. Custom angle hardware is not available.

Additional Information

Kits

- **Most profiles are available in cut to size kits**
- **Commercial** bodies and retainers should be cut 1" longer than the nominal T12 or T8 lamp size for horizontal or vertical lamping
- **Standard** bodies and retainers should be cut 1-3/4" longer than the nominal T12 or T8 lamp size for horizontal or vertical lamping (The 6" D/F bodies and retainers should be cut 1" longer than the nominal T12 or T8 lamp size for horizontal or vertical lamping)
- **EconoComp** fillers and moldings should be cut 1" longer than the normal T12 or T8 lamp size for horizontal or vertical lamping
- General guidelines for lamp spacing: Double the distance between the front of the lamp and the back of the plastic face for your center to center lamp measurement. Maximum center to center is 12"
- Extrusion bodies, retainers, frames and covers are engineered for mechanical fastening, bonding with adhesive, or welded assembly
- It is recommended to use safety chains and prop-bars on all hingeable faces
- Assembly instructions available

Included in Kits

- Mill Finish, Dk. Bronze or Clear Anodized
- Cut to size and mitered bodies
- Cut to size and mitered retainers, frames and covers
- All Body Corner Angles and/or Corner Keys as required
- Packaging

Included in Vandal System:

- Cut to size and mitered Inner Frame(s)
- Cut to size and mitered Outer Frame(s)
- Cut to size Hinge
- Locks

Not Included in Kits

- Faces or Backs
- Electrical components
- Structural supports, Frame Support Tube, back braces, gussets and mounting provisions
- Attachment of Hinge
- Drilling of holes for locks and attachment of locks

Mill Finish Dk. Bronze

- No prior surface preparation. Surface scratches, die lines and imperfections present. **Not ready for paint**
- Exposed aluminum surfaces are coated with Quaker Dark Bronze primer/topcoat
- Limited additional colors are available, minimum order will apply

Clear Anodized

- SignComp anodizes a mill finish product, therefore mill finish characteristics will be an integral part of the anodized product
- Die lines and imperfections may be seen but not felt on the finished product

Pricing

- Due to fluctuation in the raw aluminum market, prices are subject to change without notice
- Packaging is included in list prices
- For kit pricing see Kit Pricing Guide

General Information

Freight Policy

- Freight shall be prepaid, F.O.B. SignComp (Grand Rapids, MI) to any single destination within the continental United States or Canada for one shipment of extrusion and/or accessories when the invoiced amount meets or exceeds the current prepaid standard.
- Freight shall be collect, F.O.B. SignComp (Grand Rapids, MI) for all other orders.
- All freight claims for freight collect shipments are the sole responsibility of the buyer.
- SignComp will assist with freight claims. Bill of lading must be signed as "damaged" when applicable.
- Any requests for expedited freight services shall be the sole expense of the buyer.

Minimum Order

- Any single full length extrusion profile and/or prepackaged accessories
- Any single kit

Standard Lead Times

- Full-length extrusion and accessory orders: 2-3 business days upon receipt and acceptance of purchase order
- Cut to size kits and cut extrusion: 3-4 business days upon receipt and acceptance of purchase order
- All orders will receive an approximate ship date upon receipt and acceptance of purchase order and confirmation
- For custom kits and large quantities call Customer Service for lead times

Return Policy

- Returns of SignComp products will not be accepted without prior authorization and a written RMA number from SignComp.
- Materials may not be returned for any reason other than defective product or incorrect fulfillment of order.
- All goods to be returned must be acknowledged in writing within 60 days of the shipment date. Claims after this period will be considered invalid.
- All returned goods **must be in new and saleable condition** for full credit to be issued.

Additional Product Service Offerings

- Custom extrusions
- Mill Run extrusion orders
- Kerf Cutting

Exclusive Warranty and Remedies

- In effect as of January 1, 2008
- This is the exclusive warranty policy of SignComp, LLC, Grand Rapids, Michigan 49544 (the "Company") with respect to any and all of its products

Exclusive Warranty

- The Company warrants you as the original purchaser that the Company's products will be free from defects in materials and workmanship, under normal conditions, upon shipment of said products from the Company, for 30 days
- This exclusive warranty does not apply to damage caused by improper handling, therefore the company shall have no liability or responsibility for any damage whatsoever caused by handling
- The Company hereby disclaims any and all other warranties, including, without limitation, implied warranties of merchantability and fitness for a particular purpose. The only warranty with respect to the Company's products is described in this exclusive warranty. No oral or written representations shall extend the Company's exclusive warranty beyond that description herein.

Warranty Procedures

- The purchaser must notify the Company of any warranty claim prior to initiating any remedy upon the defective product. Upon receipt of such notice, the Company will direct that an authorized representative inspect the product and, if necessary, correct the defect in accordance with this exclusive warranty. The Company shall have the exclusive right to determine whether or not a defect is covered by this exclusive warranty.

Remedies

- Provided that the warranty procedures are followed, the Company will repair and/or replace the defective SignComp product(s) during the applicable warranty period without charge for parts or labor
- Repair and/or replacement of defective SignComp products is your exclusive remedy under the Company's exclusive warranty
- The Company shall not be liable for any incidental or consequential damages if the Company's product is defective or does not conform to this exclusive warranty. In any event the maximum amount for which the Company shall be liable to the purchaser shall be the original purchase price of the defective SignComp product(s).
- Any claim for breach of this exclusive warranty shall be brought, if at all, no later than 30 days from the Company's breach

Address for Notification

- Notice of a product defect covered by this exclusive warranty can be made in writing or by telephone. The Company's address and telephone numbers are:

SignComp, LLC
 3032 Walker Ridge Dr. NW
 Grand Rapids, MI. 49544
 Attention: Customer Service
 Phone: (616) 784-0405
 Toll Free: (877) 784-0405
 Fax: (616) 784-0411
 E-mail: signcomp@signcomp.com

Environmentally Friendly



Products © Processes © Facility

Our Mission: To promote business and personal practices that will decrease our impact on the environment and minimize our carbon footprint by reducing the demands placed upon our planet in an earth-friendly way.



3032 Walker Ridge Dr. NW
Grand Rapids, MI 49544
U.S.A.

toll free: (877) 784-0405 (US and Canada)

local: (616) 784-0405

fax: (616) 784-0411

email: signcomp@signcomp.com

www.signcomp.com

©SignComp LLC January 2026