







PRODUCT INFORMATION SHEET:

Flat Bleed Retro Frame II

	Part Number	Part	Length	Finish
	2107	Flat Bleed Retro Frame II	24'-6"	Mill
	2121	Flat Bleed Retro Frame Cover	24'-6"	Mill
	2124	Extended Bleed Retro Frame Cover II	24'-6"	Mill
	2127	1-1/2" Flat Retro Frame Cover II	24'-6"	Mill

NEW
Flat Bleed Retro Frame II
Part #2107

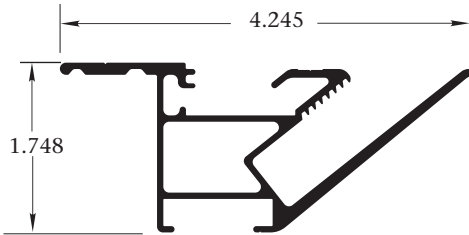

Flat Bleed Retro Frame
Part #2104

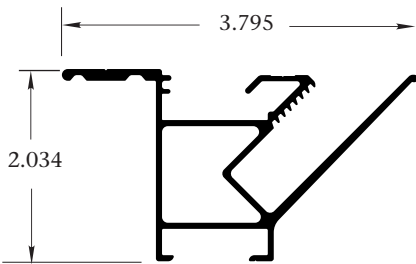

Features & Benefits

- Best solution for white transparent or light colored backgrounds.
- Flat angled inner frame helps eliminate shadows.
- Ideal for LED applications. (When using LED's, Part #5357 2 Piece Frame Brace is recommended)

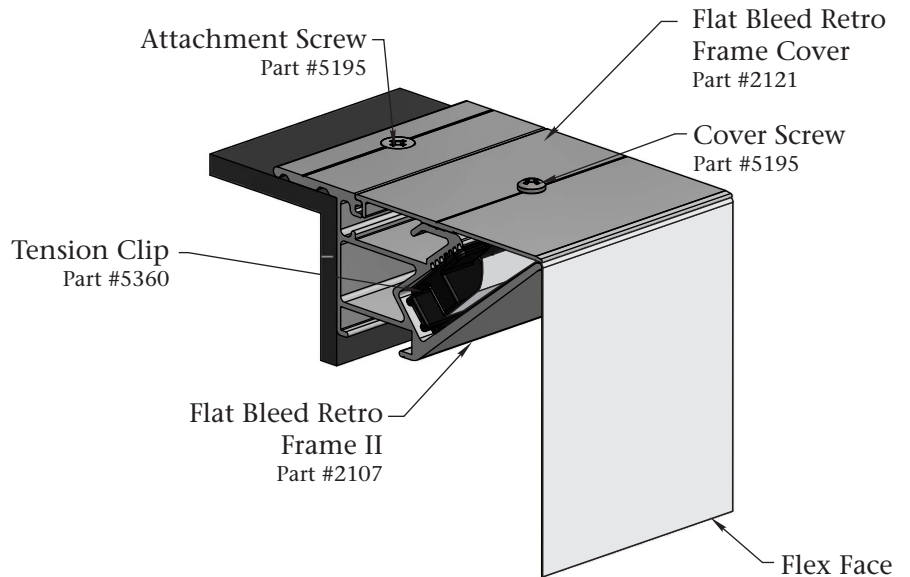

Three (3) cover options available:



Flat Bleed Retro Frame Cover
Part #2121



Extended Bleed Retro Frame Cover II
Part #2124



1-1/2" Flat Retro Frame Cover II
Part #2127