

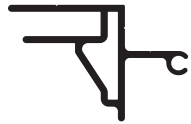

NEW PRODUCT UPDATE:

Bleed Rigid Retainer

June 2013



Part Number	Part	Length	Finish
2048	Bleed Rigid Retainer	24'-6"	Mill Finish

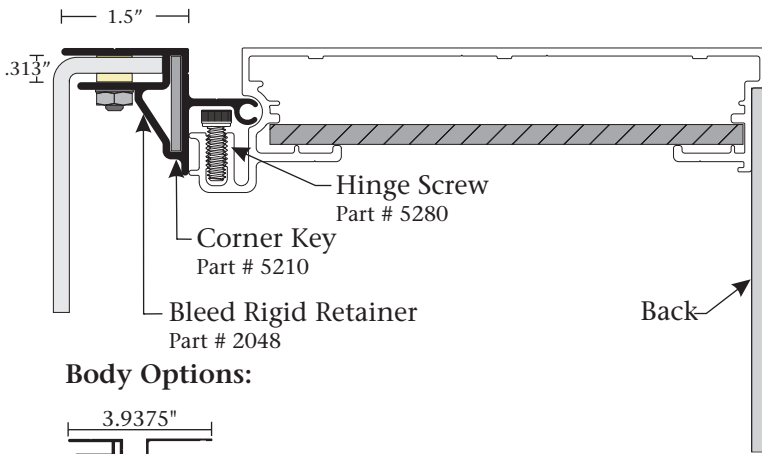

Body Options:

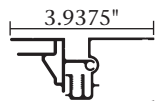

Commercial Retro Body
Part # 2040

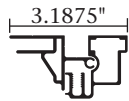

Slimline Single Face Body
Part # 2020

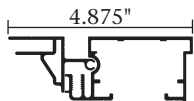

Narrow Single Face Body
Part # 2021

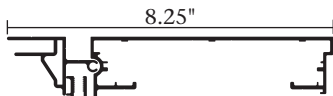

Single Face Body
Part # 2025

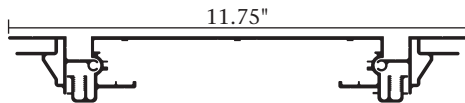

Medium Body
Part # 2015

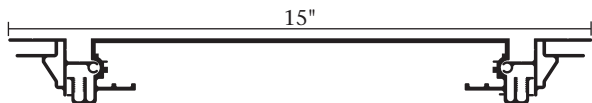

Wide Body
Part # 2005

Features & Benefits

- Allows for a frameless face appearance.
- Can be used with all Commercial bodies.
- Corner key slot provides ease of assembly and added structure.
- Allows for a hingeable face to easily access lamps for service.

