

CURRENT PRICE as
of April 1, 2022

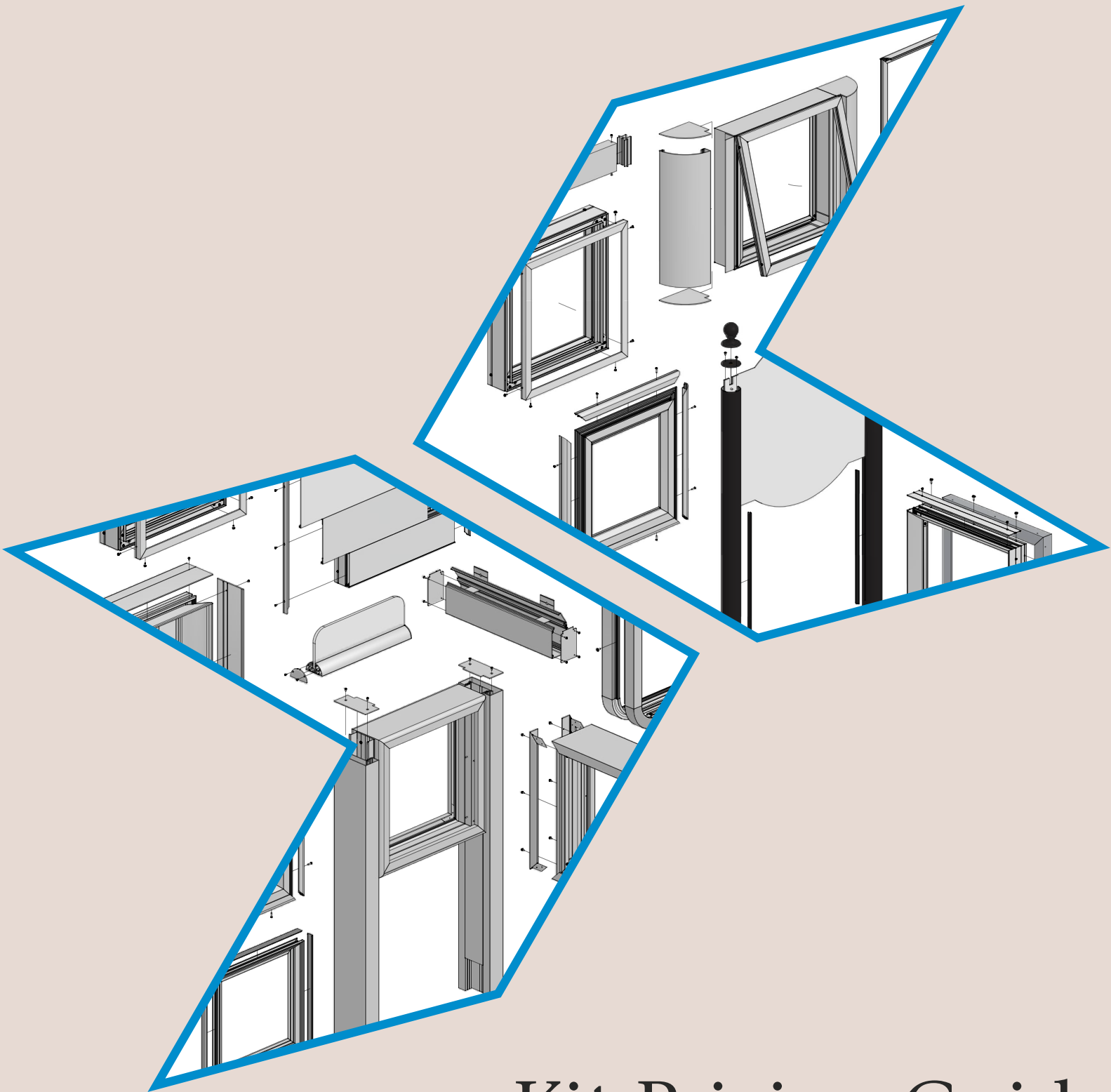

Sign Extrusions and Systems



Kit Pricing Guide

Volume 1.5

Index - Extrusion Solutions for the Sign Industry

COMMERCIAL

Commercial Kits			pages 4-126
Single Face / Double Face Kits w/ Reveal	4-75	Tension Body Kits	112-113
<i>For Rigid Faces</i>		<i>For Flexible Faces</i>	
1-1/2" Retainer	4-9	Double Face	112
1-1/2" Retainer II	10-15	Single Face	113
2-1/4" Retainer	16-21	Retro / Tension Frames	114-120
<i>For Rigid or Flexible Faces</i>		<i>For Flexible Faces</i>	
Dual Frame	22-27	2" Retro Frame	114
<i>For Pan Form Faces</i>		Bleed Retro Frame	115
Bleed Rigid Retainer	28-33	Flat Bleed Retro Frame	116
<i>For Insert Panels</i>		Flat Bleed Retro Frame w/ Wall Frame	117
Commercial Access Frame	34-39	Flat Bleed Retro Frame II	118
<i>For Flexible Faces</i>		Flat Bleed Retro Frame w/ Reflector	119
Tension Frame II	40-51	Wall Mount Tension Frame	120
Tension Frame	52-63	Soft Signage Frames	121-126
<i>For Vandal Retainers</i>		<i>For Fabric Faces</i>	
Inner Frame Retainer	64-69	Front Load Soft Signage Frames	121-122
Large Inner Frame Retainer	70-75	Soft Signage Frames	123-124
Single Face / Double Face Kits w/out Reveal	76-111	Soft Signage Snap Frames	125-126
<i>For Rigid Faces</i>		Flexible and Fabric Face Preparation	129
Flat 1-1/2" Retainer	77-83	Frame Brace / Frame Support Tube Placement	130
Flat 2" Retainer	84-90		
<i>For Pan Form Faces</i>			
Flat Bleed Rigid Retainer	91-97		
<i>For Flexible Faces</i>			
Tension Frame II	98-104		
Tension Frame	105-111		
Commercial System Optional Accessories			pages 127-128
Cut to size Divider	127		
Components	127-128		

ARCHITECTURAL

Architectural Kits			pages 131-149
Post & Panel Systems	132-139	Access Bodies Kits	140-141
<i>Non-Hingeable</i>		<i>Non-Hingeable</i>	
Series 1	132	Series 3	140
Copy Bar	133	Series 4	141
Posts / Panel Adaptors	133	Post & Panel Systems	142-149
Series 2	135	<i>Hingeable</i>	
Wall Mount Systems	135, 138	Series 7/12 Retro	142, 146
Series 3	136	Series 7 Single Face	143, 147
Series 4	137	Series 7 Double Face	144, 148
Series 7	139	Series 12 Double Face	145, 149
Architectural System Optional Accessories			page 150
Cut to size Divider	150		
Components	150		
RTS Post & Panel System			page 151

STANDARD

Standard Kits			pages 153-186
Single Face / Double Face Kits	154-181	Edge Lit Kits	183
<i>For Rigid Faces</i>		Snap Frame Kits	184
2Part Retainer	154-158	Wall Frame Kits	185
Extended Retainer	159-164	Channel Letter Raceway Bundles	186
Large Extended Retainer	165-169		
Vandal Retainer	170-175		
Large Vandal Retainer	176-181		
Standard System Optional Accessories			pages 182-183
Cut to size Divider	182		
Components	182-183		

ECONOCOMP

EconoComp Kits			pages 187 - 193
<i>For Rigid Faces</i>			
Econo Molding	188-190		
Extended Econo Molding	191-193		
EconoComp System Optional Accessories			page 194
Cut to size Divider	194		
Components	194		
Cutting Services			page 195
Additional Information			pages 196-197

Commercial Products

C O M M E R C I A L



Unassembled Retro Kits w/ Reveal - For Rigid Faces

Retro Body w/ 1-1/2" Retainer

Part #2040
K2040/55

Part #2055

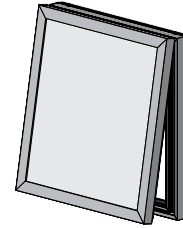
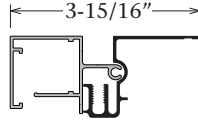

Size H'xW'	Mill Finish	Size H'xW'	Mill Finish	Size H'xW'	Mill Finish	Size H'xW'	Mill Finish
2 x 3	\$257	4 x 4	\$316	6 x 6	\$399	8 x 14	\$610
2 x 4	277	4 x 5	340	6 x 7	423	8 x 15	630
2 x 5	299	4 x 6	362	6 x 8	441	8 x 16	651
2 x 6	318	4 x 7	381	6 x 9	463	8 x 17	670
2 x 7	341	4 x 8	400	6 x 10	484	8 x 18	698
2 x 8	364	4 x 9	424	6 x 11	507	8 x 19	720
2 x 9	385	4 x 10	444	6 x 12	528	8 x 20	738
2 x 10	404	4 x 11	464	6 x 13	550		
2 x 11	425	4 x 12	485	6 x 14	569	9 x 9	520
2 x 12	445	4 x 13	511	6 x 15	591	9 x 10	544
2 x 13	468	4 x 14	532	6 x 16	611	9 x 11	564
2 x 14	487	4 x 15	551	6 x 17	631	9 x 12	586
2 x 15	514	4 x 16	571	6 x 18	653	9 x 13	606
2 x 16	534	4 x 17	594	6 x 19	673	9 x 14	627
2 x 17	552	4 x 18	617	6 x 20	699	9 x 15	648
2 x 18	575	4 x 19	633			9 x 16	670
2 x 19	598	4 x 20	655	7 x 7	441	9 x 17	694
2 x 20	618			7 x 8	460	9 x 18	717
		5 x 5	357	7 x 9	480	9 x 19	738
3 x 3	276	5 x 6	381	7 x 10	507	9 x 20	756
3 x 4	296	5 x 7	399	7 x 11	522		
3 x 5	318	5 x 8	423	7 x 12	547	10 x 10	563
3 x 6	341	5 x 9	443	7 x 13	567	10 x 11	585
3 x 7	362	5 x 10	464	7 x 14	591	10 x 12	606
3 x 8	384	5 x 11	484	7 x 15	610	10 x 13	626
3 x 9	404	5 x 12	508	7 x 16	630	10 x 14	646
3 x 10	424	5 x 13	530	7 x 17	651	10 x 15	669
3 x 11	444	5 x 14	551	7 x 18	673	10 x 16	694
3 x 12	467	5 x 15	569	7 x 19	698	10 x 17	710
3 x 13	487	5 x 16	592	7 x 20	720	10 x 18	732
3 x 14	511	5 x 17	613			10 x 19	756
3 x 15	532	5 x 18	633	8 x 8	480	10 x 20	773
3 x 16	552	5 x 19	653	8 x 9	506		
3 x 17	571	5 x 20	678	8 x 10	522		
3 x 18	594			8 x 11	547		
3 x 19	617			8 x 12	567		
3 x 20	638			8 x 13	586		

Kits Include:

- Mill Finish
- Cut to size and mitered bodies
- Cut to size and mitered retainers
- All screws required to assemble by mechanical fastening
- All Corner Angles and/or Corner Keys required
- Packaging
- Prices reflect one (1) Retro Body kit, SINGLE FACE APPLICATION

Kit Specifications:

- Kits will be cut .265" larger to fit over the existing structure
- Custom size kits may be cut to any dimension
- Illumination may vary depending on application
- 1-1/2" Retainer is not engineered to integrate with the Divider System
- For Rigid Plastic or Flush Aluminum Faces

Additional Information (pgs 196-197)

Not Included in Kits:

- Face
- Electrical Components
- Mounting Provisions

Note: All dimensions are subject to the tolerance standards of the aluminum extrusion industry. Profile drawings are illustrative and rounded to the nearest 1/16".

CURRENT PRICE as of April 1, 2022



COMMERCIAL

Unassembled Single Face Kits w/ Reveal - For Rigid Faces

Slimline Single Face Body w/ 1-1/2" Retainer

Part #2020
K2020/55

Part #2055

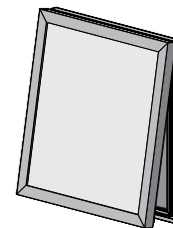
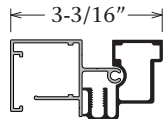

Size H'xW'	Mill Finish	Dk. Bronze	Size H'xW'	Mill Finish	Dk. Bronze	Size H'xW'	Mill Finish	Dk. Bronze	Size H'xW'	Mill Finish	Dk. Bronze
2 x 3	\$269	\$317	4 x 4	\$337	\$395	6 x 6	\$432	\$502	8 x 14	\$669	\$769
2 x 4	292	346	4 x 5	364	428	6 x 7	457	532	8 x 15	692	801
2 x 5	317	369	4 x 6	388	455	6 x 8	478	552	8 x 16	716	829
2 x 6	340	396	4 x 7	409	476	6 x 9	502	583	8 x 17	736	857
2 x 7	365	429	4 x 8	434	506	6 x 10	526	614	8 x 18	768	883
2 x 8	389	457	4 x 9	459	534	6 x 11	551	641	8 x 19	792	908
2 x 9	413	480	4 x 10	483	563	6 x 12	576	666	8 x 20	812	935
2 x 10	437	507	4 x 11	503	586	6 x 13	599	692			
2 x 11	460	535	4 x 12	528	615	6 x 14	622	724	9 x 9	569	662
2 x 12	484	564	4 x 13	555	645	6 x 15	646	748	9 x 10	594	689
2 x 13	507	595	4 x 14	579	671	6 x 16	670	774	9 x 11	617	717
2 x 14	530	617	4 x 15	601	694	6 x 17	693	804	9 x 12	642	746
2 x 15	559	646	4 x 16	625	725	6 x 18	717	831	9 x 13	666	768
2 x 16	581	674	4 x 17	649	750	6 x 19	740	859	9 x 14	689	797
2 x 17	602	699	4 x 18	676	783	6 x 20	769	885	9 x 15	710	828
2 x 18	627	728	4 x 19	694	808				9 x 16	736	857
2 x 19	654	753	4 x 20	720	832	7 x 7	478	552	9 x 17	765	880
2 x 20	677	784				7 x 8	499	581	9 x 18	788	907
			5 x 5	384	448	7 x 9	523	610	9 x 19	812	935
3 x 3	290	341	5 x 6	409	476	7 x 10	551	641	9 x 20	832	962
3 x 4	316	368	5 x 7	432	502	7 x 11	570	664			
3 x 5	340	396	5 x 8	457	532	7 x 12	597	690	10 x 10	615	716
3 x 6	365	429	5 x 9	480	559	7 x 13	621	721	10 x 11	641	745
3 x 7	388	455	5 x 10	503	586	7 x 14	646	748	10 x 12	666	768
3 x 8	412	478	5 x 11	526	614	7 x 15	669	769	10 x 13	688	796
3 x 9	437	507	5 x 12	552	642	7 x 16	692	801	10 x 14	709	825
3 x 10	459	534	5 x 13	578	669	7 x 17	716	829	10 x 15	734	853
3 x 11	483	563	5 x 14	601	694	7 x 18	740	859	10 x 16	765	880
3 x 12	506	587	5 x 15	622	724	7 x 19	768	883	10 x 17	783	906
3 x 13	530	617	5 x 16	648	749	7 x 20	792	908	10 x 18	807	932
3 x 14	555	645	5 x 17	671	781				10 x 19	832	962
3 x 15	579	671	5 x 18	694	808	8 x 8	523	610	10 x 20	853	983
3 x 16	602	699	5 x 19	717	831	8 x 9	550	637			
3 x 17	625	725	5 x 20	746	857	8 x 10	570	664			
3 x 18	649	750				8 x 11	597	690			
3 x 19	676	783				8 x 12	621	721			
3 x 20	698	811				8 x 13	642	746			

Kits Include:

- Mill Finish or Dk. Bronze
- Cut to size and mitered bodies
- Cut to size and mitered retainers
- All screws required to assemble by mechanical fastening
- All Corner Angles and/or Corner Keys required
- Packaging

Not Included in Kits:

- Face or Back
- Electrical Components
- Back Braces and Gussets
- Mounting Provisions

Kit Specifications:

- Recommended for LED applications
- Custom size kits may be cut to any dimension
- 1-1/2" Retainer is not engineered to integrate with the Divider System
- For Rigid Plastic or Flush Aluminum Faces

Additional Information (pgs 196-197)

Note: It is recommended to use safety chains and prop-bars on all hingeable faces.

Unassembled Single Face Kits w/ Reveal - For Rigid Faces

Narrow Single Face Body w/ 1-1/2" Retainer

Part #2021
K2021/55

Part #2055

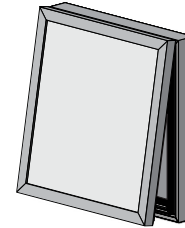
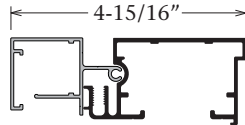

Size H'xW'	Mill Finish	Dk. Bronze	Size H'xW'	Mill Finish	Dk. Bronze	Size H'xW'	Mill Finish	Dk. Bronze	Size H'xW'	Mill Finish	Dk. Bronze
2 x 3	\$299	\$357	4 x 4	\$384	\$460	6 x 6	\$502	\$599	8 x 14	\$797	\$950
2 x 4	328	396	4 x 5	416	500	6 x 7	534	638	8 x 15	827	990
2 x 5	357	428	4 x 6	447	536	6 x 8	562	669	8 x 16	856	1026
2 x 6	387	462	4 x 7	474	567	6 x 9	591	705	8 x 17	884	1063
2 x 7	417	502	4 x 8	503	602	6 x 10	621	745	8 x 18	922	1095
2 x 8	448	539	4 x 9	535	639	6 x 11	651	778	8 x 19	951	1130
2 x 9	478	570	4 x 10	564	677	6 x 12	682	812	8 x 20	979	1164
2 x 10	507	603	4 x 11	592	708	6 x 13	710	847			
2 x 11	536	641	4 x 12	622	746	6 x 14	740	887	9 x 9	674	809
2 x 12	566	678	4 x 13	655	783	6 x 15	769	918	9 x 10	705	844
2 x 13	595	718	4 x 14	685	820	6 x 16	799	954	9 x 11	734	880
2 x 14	623	748	4 x 15	714	851	6 x 17	828	991	9 x 12	765	916
2 x 15	657	784	4 x 16	744	888	6 x 18	857	1027	9 x 13	795	948
2 x 16	688	823	4 x 17	773	922	6 x 19	887	1065	9 x 14	824	985
2 x 17	716	855	4 x 18	805	963	6 x 20	923	1098	9 x 15	853	1025
2 x 18	746	890	4 x 19	829	995				9 x 16	884	1063
2 x 19	777	924	4 x 20	860	1029	7 x 7	562	669	9 x 17	918	1092
2 x 20	807	964				7 x 8	587	704	9 x 18	948	1129
			5 x 5	443	532	7 x 9	617	740	9 x 19	979	1164
3 x 3	327	392	5 x 6	474	567	7 x 10	651	778	9 x 20	1006	1199
3 x 4	356	425	5 x 7	502	599	7 x 11	676	811			
3 x 5	387	462	5 x 8	534	638	7 x 12	708	845	10 x 10	733	878
3 x 6	417	502	5 x 9	563	673	7 x 13	738	884	10 x 11	762	915
3 x 7	447	536	5 x 10	592	708	7 x 14	769	918	10 x 12	795	948
3 x 8	476	569	5 x 11	621	745	7 x 15	797	950	10 x 13	823	983
3 x 9	507	603	5 x 12	653	780	7 x 16	827	990	10 x 14	852	1021
3 x 10	535	639	5 x 13	683	816	7 x 17	856	1026	10 x 15	883	1058
3 x 11	564	677	5 x 14	714	851	7 x 18	887	1065	10 x 16	918	1092
3 x 12	594	709	5 x 15	740	887	7 x 19	922	1095	10 x 17	943	1128
3 x 13	623	748	5 x 16	771	920	7 x 20	951	1130	10 x 18	974	1161
3 x 14	655	783	5 x 17	800	962				10 x 19	1006	1199
3 x 15	685	820	5 x 18	829	995	8 x 8	617	740	10 x 20	1030	1228
3 x 16	716	855	5 x 19	857	1027	8 x 9	649	774			
3 x 17	744	888	5 x 20	895	1063	8 x 10	676	811			
3 x 18	773	922				8 x 11	708	845			
3 x 19	805	963				8 x 12	738	884			
3 x 20	832	999				8 x 13	765	916			

Kits Include:

- Mill Finish or Dk. Bronze
- Cut to size and mitered bodies
- Cut to size and mitered retainers
- All screws required to assemble by mechanical fastening
- All Corner Angles and/or Corner Keys required
- Packaging

Not Included in Kits:

- Face or Back
- Electrical Components
- Back Braces and Gussets
- 6" Radius Corners - See optional accessories
- Mounting Provisions

Optional Accessories (pg 128):

- 6" Radius Corners

Kit Specifications:

- Recommended for LED applications
- Custom size kits may be cut to any dimension
- 1-1/2" Retainer is not engineered to integrate with the Divider System
- For Rigid Plastic or Flush Aluminum Faces

Additional Information (pgs 196-197)

Note: It is recommended to use safety chains and prop-bars on all hingeable faces.

Note: All dimensions are subject to the tolerance standards of the aluminum extrusion industry. Profile drawings are illustrative and rounded to the nearest 1/16".

CURRENT PRICE as of April 1, 2022



COMMERCIAL

Unassembled Single Face Kits w/ Reveal - For Rigid Faces

Single Face Body w/ 1-1/2" Retainer

Part #2025
KSF/55

Part #2055

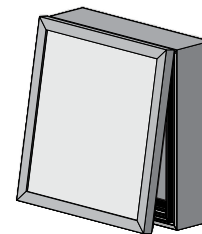
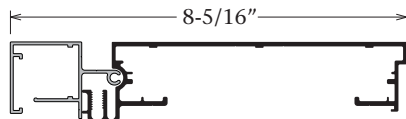

Size H'xW'	Mill Finish	Dk. Bronze	Size H'xW'	Mill Finish	Dk. Bronze	Size H'xW'	Mill Finish	Dk. Bronze	Size H'xW'	Mill Finish	Dk. Bronze
2 x 3	\$314	\$380	4 x 4	\$409	\$494	6 x 6	\$539	\$651	8 x 14	\$865	\$1042
2 x 4	346	421	4 x 5	444	539	6 x 7	574	693	8 x 15	899	1088
2 x 5	380	457	4 x 6	478	578	6 x 8	603	728	8 x 16	931	1129
2 x 6	412	495	4 x 7	508	614	6 x 9	638	769	8 x 17	960	1168
2 x 7	445	541	4 x 8	541	654	6 x 10	670	812	8 x 18	1002	1207
2 x 8	480	581	4 x 9	575	694	6 x 11	704	852	8 x 19	1034	1244
2 x 9	514	617	4 x 10	607	736	6 x 12	738	888	8 x 20	1065	1284
2 x 10	544	655	4 x 11	639	773	6 x 13	771	928	9 x 9	730	885
2 x 11	576	697	4 x 12	671	813	6 x 14	801	974	9 x 10	765	924
2 x 12	610	738	4 x 13	708	856	6 x 15	835	1009	9 x 11	797	964
2 x 13	642	781	4 x 14	742	896	6 x 16	867	1046	9 x 12	829	1007
2 x 14	673	816	4 x 15	773	931	6 x 17	900	1089	9 x 13	862	1041
2 x 15	709	857	4 x 16	805	975	6 x 18	932	1130	9 x 14	896	1083
2 x 16	744	899	4 x 17	837	1011	6 x 19	963	1170	9 x 15	928	1128
2 x 17	774	935	4 x 18	874	1057	6 x 20	1003	1209	9 x 16	960	1168
2 x 18	808	976	4 x 19	902	1094	7 x 7	603	728	9 x 17	998	1202
2 x 19	843	1014	4 x 20	935	1132	7 x 8	633	768	9 x 18	1030	1243
2 x 20	875	1058				7 x 9	667	808	9 x 19	1065	1284
			5 x 5	474	574	7 x 10	704	852	9 x 20	1094	1323
3 x 3	345	416	5 x 6	508	614	7 x 11	732	887	10 x 10	796	963
3 x 4	378	456	5 x 7	539	651	7 x 12	768	927	10 x 11	828	1006
3 x 5	412	495	5 x 8	574	693	7 x 13	800	969	10 x 12	862	1041
3 x 6	445	541	5 x 9	606	732	7 x 14	835	1009	10 x 13	895	1082
3 x 7	478	578	5 x 10	639	773	7 x 15	865	1042	10 x 14	927	1122
3 x 8	511	615	5 x 11	670	812	7 x 16	899	1088	10 x 15	959	1164
3 x 9	544	655	5 x 12	705	853	7 x 17	931	1129	10 x 16	998	1202
3 x 10	575	694	5 x 13	740	891	7 x 18	963	1170	10 x 17	1026	1241
3 x 11	607	736	5 x 14	773	931	7 x 19	1002	1207	10 x 18	1058	1280
3 x 12	641	774	5 x 15	801	974	7 x 20	1034	1244	10 x 19	1094	1323
3 x 13	673	816	5 x 16	836	1010	8 x 8	667	808	10 x 20	1121	1356
3 x 14	708	856	5 x 17	869	1055	8 x 9	702	847			
3 x 15	742	896	5 x 18	902	1094	8 x 10	732	887			
3 x 16	774	935	5 x 19	932	1130	8 x 11	768	927			
3 x 17	805	975	5 x 20	969	1168	8 x 12	800	969			
3 x 18	837	1011				8 x 13	829	1007			
3 x 19	874	1057									
3 x 20	904	1097									

Kits Include:

- Mill Finish or Dk. Bronze
- Cut to size and mitered bodies
- Cut to size and mitered retainers
- All screws required to assemble by mechanical fastening
- All Corner Angles and/or Corner Keys required
- Packaging

Not Included in Kits:

- Face or Back
- Electrical Components
- Ballast Bracket(s) - See optional accessories
- Back Braces and Gussets
- Raceway Covers and Cover Screws - See optional accessories
- 6" and 9" Radius Corners - See optional accessories
- Mounting Provisions

Optional Accessories (pgs 127-128):

- Ballast Bracket(s)
- Raceway Covers and Cover Screws
- 6" and 9" Radius Corners

Kit Specifications:

- It is recommended to order kits 1" over nominal T12 or T8 lamp size to utilize .040 flat Aluminum Raceway Covers
- Custom size kits may be cut to any dimension
- 1-1/2" Retainer is not engineered to integrate with the Divider System
- For Rigid Plastic or Flush Aluminum Faces

Recommended Lamp Spacing:

- For illuminated backgrounds - 10" on center, using T12 or T8 lamps
- Always place lamps 3/4" from back of sign

Additional Information (pgs 196-197)

Note: It is recommended to use safety chains and prop-bars on all hingeable faces.

Unassembled Double Face Kits w/ Reveal - For Rigid Faces

Medium Body w/ 1-1/2" Retainer

Part #2015
KMB/55

Part #2055

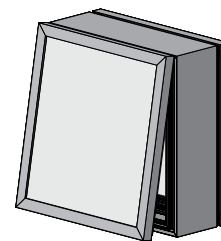
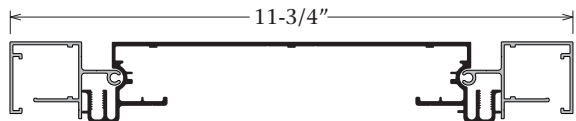

Size H'xW'	Mill Finish	Dk. Bronze	Size H'xW'	Mill Finish	Dk. Bronze	Size H'xW'	Mill Finish	Dk. Bronze	Size H'xW'	Mill Finish	Dk. Bronze
2 x 3	\$471	\$571	4 x 4	\$623	\$752	6 x 6	\$823	\$990	8 x 14	\$1327	\$1602
2 x 4	520	629	4 x 5	670	812	6 x 7	874	1057	8 x 15	1376	1664
2 x 5	574	693	4 x 6	722	874	6 x 8	920	1113	8 x 16	1427	1728
2 x 6	625	753	4 x 7	774	935	6 x 9	974	1174	8 x 17	1478	1788
2 x 7	671	813	4 x 8	824	995	6 x 10	1025	1239	8 x 18	1528	1850
2 x 8	724	875	4 x 9	875	1058	6 x 11	1073	1297	8 x 19	1578	1907
2 x 9	777	938	4 x 10	924	1118	6 x 12	1121	1356	8 x 20	1630	1968
2 x 10	827	999	4 x 11	975	1177	6 x 13	1174	1243			
2 x 11	876	1063	4 x 12	1030	1243	6 x 14	1224	1482	9 x 9	1118	1351
2 x 12	927	1122	4 x 13	1077	1304	6 x 15	1275	1546	9 x 10	1172	1416
2 x 13	981	1184	4 x 14	1130	1367	6 x 16	1328	1607	9 x 11	1221	1478
2 x 14	1030	1243	4 x 15	1177	1425	6 x 17	1379	1668	9 x 12	1274	1538
2 x 15	1082	1306	4 x 16	1228	1488	6 x 18	1431	1731	9 x 13	1325	1598
2 x 16	1133	1371	4 x 17	1279	1550	6 x 19	1479	1790	9 x 14	1375	1663
2 x 17	1180	1427	4 x 18	1331	1612	6 x 20	1530	1853	9 x 15	1427	1728
2 x 18	1233	1491	4 x 19	1381	1671				9 x 16	1474	1786
2 x 19	1285	1553	4 x 20	1432	1732	7 x 7	918	1111	9 x 17	1526	1847
2 x 20	1332	1616				7 x 8	972	1173	9 x 18	1578	1907
			5 x 5	721	872	7 x 9	1021	1236	9 x 19	1627	1966
3 x 3	520	629	5 x 6	773	931	7 x 10	1073	1297	9 x 20	1677	2028
3 x 4	571	692	5 x 7	824	995	7 x 11	1120	1355			
3 x 5	623	752	5 x 8	874	1057	7 x 12	1173	1418	10 x 10	1220	1477
3 x 6	671	813	5 x 9	922	1117	7 x 13	1224	1482	10 x 11	1271	1534
3 x 7	722	874	5 x 10	975	1177	7 x 14	1274	1538	10 x 12	1325	1598
3 x 8	774	935	5 x 11	1025	1239	7 x 15	1327	1602	10 x 13	1372	1660
3 x 9	825	999	5 x 12	1076	1302	7 x 16	1376	1664	10 x 14	1423	1719
3 x 10	875	1058	5 x 13	1129	1362	7 x 17	1430	1730	10 x 15	1474	1786
3 x 11	924	1118	5 x 14	1177	1425	7 x 18	1478	1788	10 x 16	1525	1844
3 x 12	978	1180	5 x 15	1227	1486	7 x 19	1528	1850	10 x 17	1577	1906
3 x 13	1030	1243	5 x 16	1277	1548	7 x 20	1584	1911	10 x 18	1627	1966
3 x 14	1077	1304	5 x 17	1330	1608				10 x 19	1676	2026
3 x 15	1130	1367	5 x 18	1381	1671	8 x 8	1021	1236	10 x 20	1728	2092
3 x 16	1180	1427	5 x 19	1431	1731	8 x 9	1073	1297			
3 x 17	1228	1488	5 x 20	1481	1793	8 x 10	1120	1355			
3 x 18	1279	1550				8 x 11	1173	1418			
3 x 19	1331	1612				8 x 12	1224	1482			
3 x 20	1382	1675				8 x 13	1274	1538			

Kits Include:

- Mill Finish or Dk. Bronze
- Cut to size and mitered bodies
- Cut to size and mitered retainers
- All screws required to assemble by mechanical fastening
- All Corner Angles and/or Corner Keys required
- Packaging

Not Included in Kits:

- Faces
- Electrical Components
- Ballast Bracket(s) - See optional accessories
- Internal Supports
- Raceway Covers and Cover Screws - See optional accessories
- 6" and 9" Radius Corners - See optional accessories

Optional Accessories (pgs 127-128):

- Ballast Bracket(s)
- Raceway Covers and Cover Screws
- 6" and 9" Radius Corners

Kit Specifications:

- It is recommended to order kits 1" over nominal T12 or T8 lamp size to utilize .040 flat Aluminum Raceway Covers
- Custom size kits may be cut to any dimension
- 1-1/2" Retainer is not engineered to integrate with the Divider System
- For Rigid Plastic or Flush Aluminum Faces

Recommended Lamp Spacing:

- For illuminated backgrounds - 8" on center, using T12 or T8 lamps

Additional Information (pgs 196-197)

Note: It is recommended to use safety chains and prop-bars on all hingeable faces.

Note: All dimensions are subject to the tolerance standards of the aluminum extrusion industry. Profile drawings are illustrative and rounded to the nearest 1/16".

CURRENT PRICE as of April 1, 2022



COMMERCIAL

Unassembled Double Face Kits w/ Reveal - For Rigid Faces

Wide Body w/ 1-1/2" Retainer

Part #2005
KWB/55

Part #2055

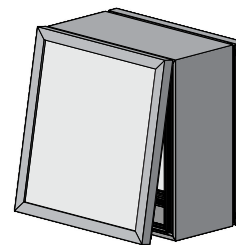
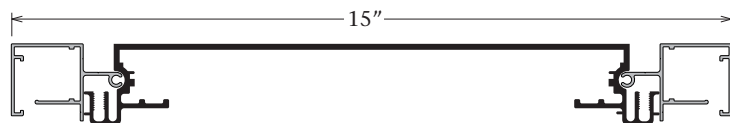

Size H'xW'	Mill Finish	Dk. Bronze	Size H'xW'	Mill Finish	Dk. Bronze	Size H'xW'	Mill Finish	Dk. Bronze	Size H'xW'	Mill Finish	Dk. Bronze
2 x 3	\$555	\$674	4 x 4	\$748	\$903	6 x 6	\$1004	\$1212	8 x 14	\$1640	\$1986
2 x 4	623	752	4 x 5	812	981	6 x 7	1066	1287	8 x 15	1707	2065
2 x 5	685	828	4 x 6	876	1063	6 x 8	1130	1367	8 x 16	1768	2140
2 x 6	749	904	4 x 7	938	1133	6 x 9	1193	1443	8 x 17	1834	2215
2 x 7	813	985	4 x 8	1006	1213	6 x 10	1259	1520	8 x 18	1898	2297
2 x 8	876	1063	4 x 9	1069	1291	6 x 11	1324	1596	8 x 19	1962	2374
2 x 9	942	1141	4 x 10	1133	1371	6 x 12	1384	1676	8 x 20	2026	2452
2 x 10	1007	1216	4 x 11	1195	1446	6 x 13	1450	1756	9 x 9	1381	1671
2 x 11	1071	1295	4 x 12	1264	1525	6 x 14	1513	1830	9 x 10	1447	1751
2 x 12	1136	1374	4 x 13	1327	1602	6 x 15	1578	1907	9 x 11	1507	1823
2 x 13	1197	1447	4 x 14	1390	1681	6 x 16	1641	1988	9 x 12	1577	1906
2 x 14	1265	1529	4 x 15	1453	1759	6 x 17	1708	2067	9 x 13	1639	1984
2 x 15	1328	1607	4 x 16	1518	1834	6 x 18	1772	2144	9 x 14	1703	2060
2 x 16	1394	1684	4 x 17	1585	1914	6 x 19	1835	2221	9 x 15	1767	2139
2 x 17	1454	1760	4 x 18	1647	1990	6 x 20	1900	2298	9 x 16	1834	2215
2 x 18	1520	1838	4 x 19	1709	2069	7 x 7	1129	1362	9 x 17	1897	2295
2 x 19	1586	1919	4 x 20	1775	2146	7 x 8	1192	1441	9 x 18	1961	2373
2 x 20	1651	1996				7 x 9	1259	1520	9 x 19	2024	2449
			5 x 5	875	1058	7 x 10	1319	1595	9 x 20	2089	2527
3 x 3	618	750	5 x 6	938	1133	7 x 11	1382	1675	10 x 10	1507	1823
3 x 4	685	828	5 x 7	1004	1212	7 x 12	1449	1755	10 x 11	1574	1898
3 x 5	748	903	5 x 8	1067	1290	7 x 13	1513	1830	10 x 12	1639	1984
3 x 6	812	981	5 x 9	1133	1371	7 x 14	1577	1906	10 x 13	1702	2055
3 x 7	876	1063	5 x 10	1193	1443	7 x 15	1640	1986	10 x 14	1764	2135
3 x 8	938	1133	5 x 11	1263	1523	7 x 16	1707	2065	10 x 15	1833	2212
3 x 9	1006	1213	5 x 12	1325	1598	7 x 17	1768	2140	10 x 16	1897	2295
3 x 10	1069	1291	5 x 13	1390	1681	7 x 18	1835	2221	10 x 17	1958	2372
3 x 11	1134	1372	5 x 14	1450	1756	7 x 19	1898	2297	10 x 18	2023	2448
3 x 12	1197	1447	5 x 15	1516	1833	7 x 20	1962	2374	10 x 19	2088	2526
3 x 13	1264	1525	5 x 16	1584	1911	8 x 8	1253	1518	10 x 20	2154	2604
3 x 14	1327	1602	5 x 17	1644	1989	8 x 9	1319	1595			
3 x 15	1393	1683	5 x 18	1709	2069	8 x 10	1382	1675			
3 x 16	1454	1760	5 x 19	1772	2144	8 x 11	1449	1755			
3 x 17	1518	1834	5 x 20	1838	2222	8 x 12	1513	1830			
3 x 18	1585	1914				8 x 13	1577	1906			
3 x 19	1647	1990									
3 x 20	1711	2073									

Kits Include:

- Mill Finish or Dk. Bronze
- Cut to size and mitered bodies
- Cut to size and mitered retainers
- All screws required to assemble by mechanical fastening
- All Corner Angles and/or Corner Keys required
- Packaging

Not Included in Kits:

- Faces
- Electrical Components
- Ballast Bracket(s) - See optional accessories
- Internal Supports
- Raceway Covers and Cover Screws - See optional accessories
- 6" and 9" Radius Corners - See optional accessories

Optional Accessories (pgs 127-128):

- Ballast Bracket(s)
- Raceway Covers and Cover Screws
- 6" and 9" Radius Corners

Kit Specifications:

- It is recommended to order kits 1" over nominal T12 or T8 lamp size to utilize .040 flat Aluminum Raceway Covers
- Custom size kits may be cut to any dimension
- 1-1/2" Retainer is not engineered to integrate with the Divider System
- For Rigid Plastic or Flush Aluminum Faces

Recommended Lamp Spacing:

- For illuminated backgrounds - 12" on center, using T12 or T8 lamps

Additional Information (pgs 196-197)

Note: It is recommended to use safety chains and prop-bars on all hingeable faces.

Unassembled Retro Kits w/ Reveal - For Rigid Faces

Retro Body w/ 1-1/2" Retainer II

Part #2040
K2040/53

Part #2053

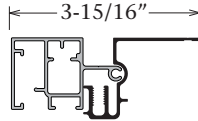

One Side Removable w/
1-1/2" Frame, Part #2063
1-1/2" Frame Cover, Part #2073

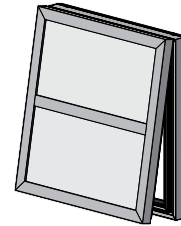

Shown with optional divider

Size H'xW'	Mill Finish	Size H'xW'	Mill Finish	Size H'xW'	Mill Finish	Size H'xW'	Mill Finish
2 x 3	\$270	4 x 4	\$343	6 x 6	\$440	8 x 14	\$662
2 x 4	290	4 x 5	367	6 x 7	462	8 x 15	683
2 x 5	312	4 x 6	388	6 x 8	483	8 x 16	704
2 x 6	334	4 x 7	409	6 x 9	503	8 x 17	724
2 x 7	356	4 x 8	429	6 x 10	523	8 x 18	748
2 x 8	378	4 x 9	450	6 x 11	546	8 x 19	769
2 x 9	397	4 x 10	471	6 x 12	567	8 x 20	789
2 x 10	417	4 x 11	492	6 x 13	590		
2 x 11	440	4 x 12	514	6 x 14	607	9 x 9	581
2 x 12	460	4 x 13	536	6 x 15	629	9 x 10	603
2 x 13	483	4 x 14	555	6 x 16	649	9 x 11	623
2 x 14	500	4 x 15	578	6 x 17	671	9 x 12	646
2 x 15	526	4 x 16	598	6 x 18	693	9 x 13	669
2 x 16	547	4 x 17	621	6 x 19	714	9 x 14	689
2 x 17	566	4 x 18	641	6 x 20	736	9 x 15	709
2 x 18	587	4 x 19	661			9 x 16	730
2 x 19	610	4 x 20	681	7 x 7	490	9 x 17	753
2 x 20	629			7 x 8	508	9 x 18	776
		5 x 5	392	7 x 9	528	9 x 19	796
		5 x 6	415	7 x 10	551	9 x 20	816
		5 x 7	434	7 x 11	570		
		5 x 8	456	7 x 12	595	10 x 10	630
		5 x 9	476	7 x 13	613	10 x 11	651
		5 x 10	499	7 x 14	637	10 x 12	673
		5 x 11	519	7 x 15	655	10 x 13	693
		5 x 12	541	7 x 16	678	10 x 14	714
		5 x 13	563	7 x 17	699	10 x 15	734
		5 x 14	585	7 x 18	720	10 x 16	758
		5 x 15	602	7 x 19	744	10 x 17	778
		5 x 16	626	7 x 20	765	10 x 18	799
		5 x 17	645			10 x 19	823
		5 x 18	667	8 x 8	535	10 x 20	840
		5 x 19	688	8 x 9	560		
		5 x 20	709	8 x 10	576		
				8 x 11	599		
				8 x 12	621		
				8 x 13	641		

Kits Include:

- Mill Finish
- Cut to size and mitered bodies
- Cut to size and mitered retainers
- **One vertical side will be 1-1/2" Frame (2063) with 1-1/2" Frame Cover (2073) to allow for sliding the rigid plastic face in and out**
- All screws required to assemble by mechanical fastening
- All Corner Angles and/or Corner Keys required
- Packaging
- Prices reflect one (1) Retro Body kit, SINGLE FACE

Not Included in Kits:

- Face
- Electrical Components
- Divider(s) - See optional accessories
- Mounting Provisions

Optional Accessories (pg 127):

- Divider(s)

Kit Specifications:

- Kits will be cut .265" larger to fit over existing structure
- Custom size kits may be cut to any dimension
- Illumination may vary depending on application
- For Rigid Plastic or Flush Aluminum Faces

Divider Kits Include:

- Cut to size dividers
- Divider Corner Angles
- All screws required to assemble by mechanical fastening
- **1-1/2" Divider, Part #2133, \$5.48 per/ft per/face**

Additional Information (pgs 196-197)

Note: All dimensions are subject to the tolerance standards of the aluminum extrusion industry. Profile drawings are illustrative and rounded to the nearest 1/16".

CURRENT PRICE as of April 1, 2022



COMMERCIAL

Unassembled Single Face Kits w/ Reveal - For Rigid Faces

Slimline Single Face Body w/ 1-1/2" Retainer II

Part #2020
K2020/53

Part #2053

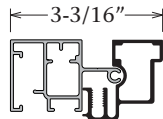

One Side Removable w/
1-1/2" Frame, Part #2063
1-1/2" Frame Cover, Part #2073

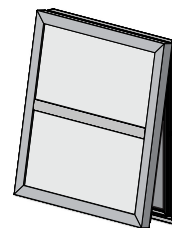

Shown with optional divider

Size H'xW'	Mill Finish	Dk. Bronze	Size H'xW'	Mill Finish	Dk. Bronze	Size H'xW'	Mill Finish	Dk. Bronze	Size H'xW'	Mill Finish	Dk. Bronze
2 x 3	\$282	\$337	4 x 4	\$365	\$431	6 x 6	\$472	\$551	8 x 14	\$721	\$835
2 x 4	306	369	4 x 5	389	460	6 x 7	495	581	8 x 15	745	865
2 x 5	332	397	4 x 6	415	487	6 x 8	519	602	8 x 16	768	891
2 x 6	356	429	4 x 7	437	514	6 x 9	542	630	8 x 17	792	920
2 x 7	380	464	4 x 8	462	538	6 x 10	567	662	8 x 18	817	947
2 x 8	404	499	4 x 9	485	566	6 x 11	591	688	8 x 19	840	974
2 x 9	425	524	4 x 10	508	594	6 x 12	615	716	8 x 20	863	999
2 x 10	450	555	4 x 11	532	621	6 x 13	639	742			
2 x 11	474	587	4 x 12	555	648	6 x 14	661	771	9 x 9	629	732
2 x 12	496	621	4 x 13	581	676	6 x 15	685	797	9 x 10	654	761
2 x 13	520	655	4 x 14	603	702	6 x 16	708	823	9 x 11	676	789
2 x 14	544	682	4 x 15	627	729	6 x 17	732	853	9 x 12	701	813
2 x 15	571	716	4 x 16	651	755	6 x 18	756	880	9 x 13	728	843
2 x 16	595	749	4 x 17	676	783	6 x 19	780	907	9 x 14	749	869
2 x 17	615	776	4 x 18	699	812	6 x 20	807	932	9 x 15	774	899
2 x 18	641	808	4 x 19	721	839				9 x 16	797	928
2 x 19	666	840	4 x 20	745	863	7 x 7	526	613	9 x 17	824	951
2 x 20	689	875				7 x 8	547	639	9 x 18	847	979
			5 x 5	417	491	7 x 9	571	667	9 x 19	871	1006
3 x 3	312	367	5 x 6	443	518	7 x 10	597	697	9 x 20	891	1034
3 x 4	337	396	5 x 7	467	544	7 x 11	618	720			
3 x 5	362	429	5 x 8	490	574	7 x 12	645	749	10 x 10	683	796
3 x 6	384	464	5 x 9	515	599	7 x 13	666	777	10 x 11	706	823
3 x 7	409	492	5 x 10	538	626	7 x 14	692	804	10 x 12	732	849
3 x 8	432	523	5 x 11	563	654	7 x 15	716	827	10 x 13	753	876
3 x 9	457	555	5 x 12	586	682	7 x 16	740	857	10 x 14	777	906
3 x 10	480	586	5 x 13	611	708	7 x 17	762	885	10 x 15	801	934
3 x 11	503	617	5 x 14	633	733	7 x 18	785	914	10 x 16	828	959
3 x 12	526	649	5 x 15	655	765	7 x 19	812	939	10 x 17	851	985
3 x 13	551	682	5 x 16	682	789	7 x 20	836	964	10 x 18	874	1013
3 x 14	576	714	5 x 17	704	821				10 x 19	899	1039
3 x 15	599	748	5 x 18	728	845	8 x 8	578	673	10 x 20	922	1065
3 x 16	622	776	5 x 19	750	871	8 x 9	603	699			
3 x 17	645	807	5 x 20	777	899	8 x 10	625	729			
3 x 18	670	837				8 x 11	649	755			
3 x 19	694	872				8 x 12	673	784			
3 x 20	718	903				8 x 13	697	809			

Kits Include:

- Mill Finish or Dk. Bronze
- Cut to size and mitered bodies
- Cut to size and mitered retainers
- One vertical side will be 1-1/2" Frame (2063) with 1-1/2" Frame Cover (2073) to allow for sliding the rigid plastic face in and out
- All screws required to assemble by mechanical fastening
- All Corner Angles and/or Corner Keys required
- Packaging

Not Included in Kits:

- Face or Back
- Electrical Components
- Back Braces and Gussets
- Divider(s) - See optional accessories
- Mounting Provisions

Optional Accessories (pg 127):

- Divider(s)

Kit Specifications:

- Recommended for LED applications
- Custom size kits may be cut to any dimension
- For Rigid Plastic or Flush Aluminum Faces

Divider Kits Include:

- Cut to size dividers
- Divider Corner Angles
- All screws required to assemble by mechanical fastening
- 1-1/2" Divider, Part #2133, Mill Finish \$5.48 and Dk. Bronze \$7.14 per/ft per/face

Additional Information (pgs 196-197)

Note: It is recommended to use safety chains and prop-bars on all hingeable faces.

Unassembled Single Face Kits w/ Reveal - For Rigid Faces

Narrow Single Face Body w/ 1-1/2" Retainer II

Part #2021
K2021/53

Part #2053

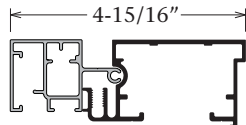

One Side Removable w/
1-1/2" Frame, Part #2063
1-1/2" Frame Cover, Part #2073

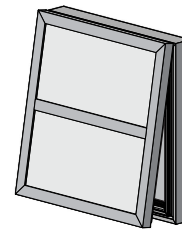

Shown with optional divider

Size H'xW'	Mill Finish	Dk. Bronze	Size H'xW'	Mill Finish	Dk. Bronze	Size H'xW'	Mill Finish	Dk. Bronze	Size H'xW'	Mill Finish	Dk. Bronze
2 x 3	\$312	\$377	4 x 4	\$412	\$495	6 x 6	\$542	\$649	8 x 14	\$851	\$1014
2 x 4	341	412	4 x 5	443	534	6 x 7	571	688	8 x 15	880	1054
2 x 5	371	444	4 x 6	474	569	6 x 8	601	718	8 x 16	908	1088
2 x 6	403	483	4 x 7	502	602	6 x 9	630	753	8 x 17	938	1125
2 x 7	432	519	4 x 8	532	637	6 x 10	661	793	8 x 18	972	1160
2 x 8	463	554	4 x 9	562	671	6 x 11	690	825	8 x 19	1002	1193
2 x 9	491	587	4 x 10	591	708	6 x 12	721	862	8 x 20	1030	1227
2 x 10	520	622	4 x 11	621	744	6 x 13	750	897			
2 x 11	550	655	4 x 12	649	778	6 x 14	778	934	9 x 9	734	880
2 x 12	579	694	4 x 13	681	813	6 x 15	808	967	9 x 10	767	916
2 x 13	610	732	4 x 14	709	851	6 x 16	837	1003	9 x 11	795	953
2 x 14	638	765	4 x 15	740	884	6 x 17	867	1041	9 x 12	824	985
2 x 15	671	800	4 x 16	769	918	6 x 18	899	1076	9 x 13	856	1022
2 x 16	701	836	4 x 17	799	954	6 x 19	928	1113	9 x 14	884	1057
2 x 17	728	872	4 x 18	828	992	6 x 20	960	1145	9 x 15	915	1094
2 x 18	758	906	4 x 19	856	1027				9 x 16	944	1133
2 x 19	788	938	4 x 20	885	1060	7 x 7	610	728	9 x 17	978	1164
2 x 20	817	979				7 x 8	637	761	9 x 18	1007	1199
			5 x 5	476	574	7 x 9	666	797	9 x 19	1037	1235
3 x 3	348	419	5 x 6	508	607	7 x 10	697	835	9 x 20	1065	1271
3 x 4	378	452	5 x 7	536	642	7 x 11	724	867			
3 x 5	409	488	5 x 8	566	678	7 x 12	756	904	10 x 10	801	959
3 x 6	437	523	5 x 9	597	716	7 x 13	783	939	10 x 11	829	992
3 x 7	468	562	5 x 10	626	749	7 x 14	813	975	10 x 12	860	1029
3 x 8	496	594	5 x 11	655	784	7 x 15	844	1007	10 x 13	888	1065
3 x 9	526	629	5 x 12	685	821	7 x 16	875	1045	10 x 14	918	1102
3 x 10	555	666	5 x 13	717	856	7 x 17	904	1082	10 x 15	950	1138
3 x 11	586	701	5 x 14	746	888	7 x 18	934	1118	10 x 16	982	1172
3 x 12	615	734	5 x 15	774	928	7 x 19	966	1153	10 x 17	1010	1207
3 x 13	645	771	5 x 16	805	960	7 x 20	995	1186	10 x 18	1039	1241
3 x 14	676	805	5 x 17	832	1002				10 x 19	1070	1277
3 x 15	705	844	5 x 18	862	1034	8 x 8	671	804	10 x 20	1098	1311
3 x 16	733	878	5 x 19	891	1066	8 x 9	704	837			
3 x 17	762	914	5 x 20	924	1104	8 x 10	730	876			
3 x 18	793	947				8 x 11	761	911			
3 x 19	824	985				8 x 12	792	948			
3 x 20	853	1021				8 x 13	820	981			

Kits Include:

- Mill Finish or Dk. Bronze
- Cut to size and mitered bodies
- Cut to size and mitered retainers
- One vertical side will be 1-1/2" Frame (2063) with 1-1/2" Frame Cover (2073) to allow for sliding the rigid plastic face in and out
- All screws required to assemble by mechanical fastening
- All Corner Angles and/or Corner Keys required
- Packaging

Not Included in Kits:

- Face or Back
- Electrical Components
- Back Braces and Gussets
- Divider(s) - See optional accessories
- Mounting Provisions

Optional Accessories (pg 127):

- Divider(s)

Kit Specifications:

- Recommended for LED applications
- Custom size kits may be cut to any dimension
- For Rigid Plastic or Flush Aluminum Faces

Divider Kits Include:

- Cut to size dividers
- Divider Corner Angles
- All screws required to assemble by mechanical fastening
- 1-1/2" Divider, Part #2133, Mill Finish \$5.48 and Dk. Bronze \$7.14 per/ft per/face

Additional Information (pgs 196-197)

Note: It is recommended to use safety chains and prop-bars on all hingeable faces.

Note: All dimensions are subject to the tolerance standards of the aluminum extrusion industry. Profile drawings are illustrative and rounded to the nearest 1/16".

CURRENT PRICE as of April 1, 2022



COMMERCIAL

Unassembled Single Face Kits w/ Reveal - For Rigid Faces

Single Face Body w/ 1-1/2" Retainer II

Part #2025
KSF/53

Part #2053

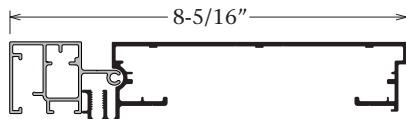

One Side Removable w/
1-1/2" Frame, Part #2063
1-1/2" Frame Cover, Part #2073

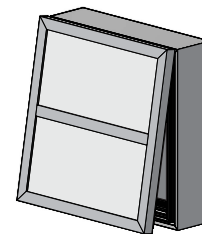

Shown with optional divider

Size H'xW'	Mill Finish	Dk. Bronze	Size H'xW'	Mill Finish	Dk. Bronze	Size H'xW'	Mill Finish	Dk. Bronze	Size H'xW'	Mill Finish	Dk. Bronze
2 x 3	\$328	\$397	4 x 4	\$437	\$530	6 x 6	\$579	\$701	8 x 14	\$918	\$1109
2 x 4	361	437	4 x 5	471	571	6 x 7	613	744	8 x 15	951	1150
2 x 5	393	474	4 x 6	506	611	6 x 8	645	777	8 x 16	983	1190
2 x 6	428	516	4 x 7	536	649	6 x 9	677	817	8 x 17	1014	1232
2 x 7	460	559	4 x 8	569	688	6 x 10	709	860	8 x 18	1051	1269
2 x 8	494	597	4 x 9	601	728	6 x 11	744	899	8 x 19	1083	1309
2 x 9	524	633	4 x 10	633	768	6 x 12	777	938	8 x 20	1116	1347
2 x 10	559	673	4 x 11	667	807	6 x 13	809	978			
2 x 11	591	710	4 x 12	699	847	6 x 14	840	1019	9 x 9	792	956
2 x 12	623	753	4 x 13	733	887	6 x 15	874	1058	9 x 10	825	998
2 x 13	655	796	4 x 14	767	927	6 x 16	906	1095	9 x 11	856	1038
2 x 14	688	832	4 x 15	799	964	6 x 17	938	1138	9 x 12	888	1076
2 x 15	724	874	4 x 16	831	1004	6 x 18	974	1177	9 x 13	924	1116
2 x 16	756	912	4 x 17	863	1043	6 x 19	1004	1218	9 x 14	956	1156
2 x 17	785	953	4 x 18	897	1086	6 x 20	1039	1255	9 x 15	990	1196
2 x 18	821	991	4 x 19	928	1125				9 x 16	1021	1239
2 x 19	853	1029	4 x 20	960	1162	7 x 7	653	785	9 x 17	1057	1274
2 x 20	885	1071				7 x 8	682	825	9 x 18	1089	1315
			5 x 5	508	615	7 x 9	716	865	9 x 19	1121	1354
3 x 3	367	444	5 x 6	542	654	7 x 10	749	907	9 x 20	1153	1394
3 x 4	399	483	5 x 7	574	693	7 x 11	780	943			
3 x 5	434	522	5 x 8	606	734	7 x 12	816	985	10 x 10	863	1043
3 x 6	464	563	5 x 9	641	774	7 x 13	845	1026	10 x 11	896	1083
3 x 7	499	602	5 x 10	673	812	7 x 14	880	1065	10 x 12	930	1121
3 x 8	532	641	5 x 11	705	853	7 x 15	912	1100	10 x 13	960	1162
3 x 9	564	681	5 x 12	738	895	7 x 16	947	1144	10 x 14	992	1205
3 x 10	597	721	5 x 13	773	932	7 x 17	979	1184	10 x 15	1026	1244
3 x 11	629	760	5 x 14	805	969	7 x 18	1010	1224	10 x 16	1061	1283
3 x 12	662	799	5 x 15	836	1013	7 x 19	1045	1264	10 x 17	1092	1320
3 x 13	694	839	5 x 16	871	1051	7 x 20	1079	1300	10 x 18	1125	1362
3 x 14	729	878	5 x 17	902	1094				10 x 19	1160	1400
3 x 15	761	920	5 x 18	934	1132	8 x 8	721	872	10 x 20	1190	1438
3 x 16	793	959	5 x 19	966	1168	8 x 9	756	911			
3 x 17	825	999	5 x 20	1002	1209	8 x 10	785	953			
3 x 18	857	1037				8 x 11	821	991			
3 x 19	891	1079				8 x 12	853	1034			
3 x 20	924	1118				8 x 13	884	1070			

Kits Include:

- Mill Finish or Dk. Bronze
- Cut to size and mitered bodies
- Cut to size and mitered retainers
- One vertical side will be 1-1/2" Frame (2063) with 1-1/2" Frame Cover (2073) to allow for sliding the rigid plastic face in and out
- All screws required to assemble by mechanical fastening
- All Corner Angles and/or Corner Keys required
- Packaging

Not Included in Kits:

- Face or Back
- Electrical Components
- Ballast Bracket(s) - See optional accessories
- Back Braces and Gussets
- Raceway Covers and Cover Screws - See optional accessories
- Divider(s) - See optional accessories
- Mounting Provisions

Optional Accessories (pg 127):

- Ballast Bracket(s)
- Raceway Covers and Cover Screws
- Divider(s)

Kit Specifications:

- It is recommended to order kits 1" over nominal T12 or T8 lamp size to utilize .040 flat Aluminum Raceway Covers
- Custom size kits may be cut to any dimension
- For Rigid Plastic or Flush Aluminum Faces

Recommended Lamp Spacing:

- For illuminated backgrounds - 10" on center, using T12 or T8 lamps
- Always place lamps 3/4" from back of sign

Divider Kits Include:

- Cut to size dividers
- Divider Corner Angles
- All screws required to assemble by mechanical fastening
- 1-1/2" Divider, Part #2133, Mill Finish \$5.48 and Dk. Bronze \$7.14 per/ft per/face

Additional Information (pgs 196-197)

Note: It is recommended to use safety chains and prop-bars on all hingeable faces.

Unassembled Double Face Kits w/ Reveal - For Rigid Faces

Medium Body w/ 1-1/2" Retainer II

Part #2015
KMB/53

Part #2053

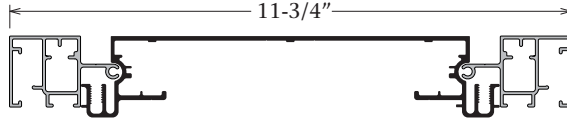

One Side Removable w/
1-1/2" Frame, Part #2063
1-1/2" Frame Cover, Part #2073

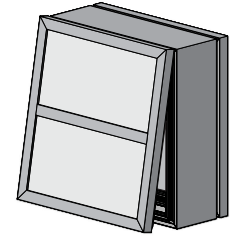

Shown with optional divider

Size H'xW'	Mill Finish	Dk. Bronze	Size H'xW'	Mill Finish	Dk. Bronze	Size H'xW'	Mill Finish	Dk. Bronze	Size H'xW'	Mill Finish	Dk. Bronze
2 x 3	\$500	\$607	4 x 4	\$678	\$820	6 x 6	\$904	\$1089	8 x 14	\$1432	\$1731
2 x 4	548	666	4 x 5	725	878	6 x 7	953	1153	8 x 15	1482	1794
2 x 5	601	728	4 x 6	778	938	6 x 8	1003	1212	8 x 16	1533	1855
2 x 6	653	788	4 x 7	828	1002	6 x 9	1054	1272	8 x 17	1584	1916
2 x 7	701	849	4 x 8	880	1063	6 x 10	1105	1336	8 x 18	1633	1976
2 x 8	752	908	4 x 9	931	1122	6 x 11	1150	1395	8 x 19	1683	2035
2 x 9	804	972	4 x 10	978	1184	6 x 12	1202	1455	8 x 20	1736	2095
2 x 10	855	1031	4 x 11	1029	1243	6 x 13	1253	1520	9 x 9	1240	1500
2 x 11	903	1094	4 x 12	1082	1306	6 x 14	1303	1577	9 x 10	1291	1561
2 x 12	954	1158	4 x 13	1130	1370	6 x 15	1355	1641	9 x 11	1342	1623
2 x 13	1007	1216	4 x 14	1181	1430	6 x 16	1406	1703	9 x 12	1394	1686
2 x 14	1055	1274	4 x 15	1233	1488	6 x 17	1458	1762	9 x 13	1446	1744
2 x 15	1106	1339	4 x 16	1283	1550	6 x 18	1509	1822	9 x 14	1495	1807
2 x 16	1158	1402	4 x 17	1331	1612	6 x 19	1558	1883	9 x 15	1546	1870
2 x 17	1207	1457	4 x 18	1382	1676	6 x 20	1608	1945	9 x 16	1595	1928
2 x 18	1259	1522	4 x 19	1432	1731	7 x 7	1013	1225	9 x 17	1647	1990
2 x 19	1311	1584	4 x 20	1485	1794	7 x 8	1065	1288	9 x 18	1697	2049
2 x 20	1358	1647				7 x 9	1116	1350	9 x 19	1746	2109
			5 x 5	789	956	7 x 10	1165	1410	9 x 20	1794	2171
3 x 3	563	682	5 x 6	839	1014	7 x 11	1216	1469	10 x 10	1354	1637
3 x 4	613	742	5 x 7	890	1077	7 x 12	1267	1530	10 x 11	1404	1697
3 x 5	666	801	5 x 8	942	1138	7 x 13	1318	1595	10 x 12	1457	1759
3 x 6	714	863	5 x 9	990	1197	7 x 14	1367	1653	10 x 13	1505	1821
3 x 7	765	923	5 x 10	1041	1259	7 x 15	1419	1714	10 x 14	1556	1881
3 x 8	816	983	5 x 11	1090	1319	7 x 16	1470	1776	10 x 15	1607	1944
3 x 9	867	1050	5 x 12	1142	1382	7 x 17	1522	1838	10 x 16	1656	2002
3 x 10	915	1109	5 x 13	1193	1441	7 x 18	1570	1900	10 x 17	1709	2065
3 x 11	964	1168	5 x 14	1244	1502	7 x 19	1620	1961	10 x 18	1759	2124
3 x 12	1018	1228	5 x 15	1295	1565	7 x 20	1672	2021	10 x 19	1807	2186
3 x 13	1069	1291	5 x 16	1343	1625	8 x 8	1130	1366	10 x 20	1859	2249
3 x 14	1118	1354	5 x 17	1395	1687	8 x 9	1180	1426			
3 x 15	1167	1415	5 x 18	1446	1748	8 x 10	1227	1485			
3 x 16	1220	1474	5 x 19	1497	1809	8 x 11	1280	1546			
3 x 17	1269	1534	5 x 20	1545	1870	8 x 12	1331	1609			
3 x 18	1319	1598				8 x 13	1379	1668			
3 x 19	1371	1657									
3 x 20	1421	1718									

Kits Include:

- Mill Finish or Dk. Bronze
- Cut to size and mitered bodies
- Cut to size and mitered retainers
- One vertical side will be 1-1/2" Frame (2063) with 1-1/2" Frame Cover (2073) to allow for sliding the rigid plastic faces in and out
- All screws required to assemble by mechanical fastening
- All Corner Angles and/or Corner Keys required
- Packaging

Not Included in Kits:

- Faces
- Electrical Components
- Ballast Bracket(s) - See optional accessories
- Internal Supports
- Raceway Covers and Cover Screws - See optional accessories
- Divider(s) - See optional accessories

Optional Accessories (pg 127):

- Ballast Bracket(s)
- Raceway Covers and Cover Screws
- Divider(s)

Kit Specifications:

- It is recommended to order kits 1" over nominal T12 or T8 lamp size to utilize .040 flat Aluminum Raceway Covers
- Custom size kits may be cut to any dimension
- For Rigid Plastic or Flush Aluminum Faces

Recommended Lamp Spacing:

- For illuminated backgrounds - 8" on center, using T12 or T8 lamps

Divider Kits Include:

- Cut to size dividers
- Divider Corner Angles
- All screws required to assemble by mechanical fastening
- 1-1/2" Divider, Part #2133, Mill Finish \$5.48 and Dk. Bronze \$7.14 per/ft per/face

Additional Information (pgs 196-197)

Note: It is recommended to use safety chains and prop-bars on all hingeable faces.

Note: All dimensions are subject to the tolerance standards of the aluminum extrusion industry. Profile drawings are illustrative and rounded to the nearest 1/16".

CURRENT PRICE as of April 1, 2022



COMMERCIAL

Unassembled Double Face Kits w/ Reveal - For Rigid Faces

Wide Body w/ 1-1/2" Retainer II

Part #2005
KWB/53

Part #2053

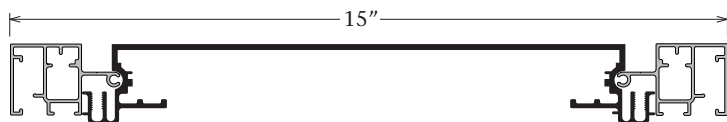

One Side Removable w/
1-1/2" Frame, Part #2063
1-1/2" Frame Cover, Part #2073

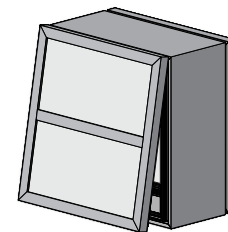

Shown with optional divider

Size H'xW'	Mill Finish	Dk. Bronze	Size H'xW'	Mill Finish	Dk. Bronze	Size H'xW'	Mill Finish	Dk. Bronze	Size H'xW'	Mill Finish	Dk. Bronze
2 x 3	\$586	\$709	4 x 4	\$804	\$974	6 x 6	\$1083	\$1311	8 x 14	\$1748	\$2115
2 x 4	651	788	4 x 5	867	1046	6 x 7	1146	1387	8 x 15	1812	2194
2 x 5	714	862	4 x 6	932	1129	6 x 8	1211	1466	8 x 16	1874	2267
2 x 6	778	939	4 x 7	994	1201	6 x 9	1275	1542	8 x 17	1940	2345
2 x 7	843	1021	4 x 8	1061	1280	6 x 10	1339	1617	8 x 18	2004	2424
2 x 8	906	1098	4 x 9	1122	1358	6 x 11	1403	1697	8 x 19	2068	2503
2 x 9	969	1173	4 x 10	1188	1438	6 x 12	1466	1772	8 x 20	2130	2579
2 x 10	1035	1249	4 x 11	1251	1511	6 x 13	1528	1849			
2 x 11	1100	1328	4 x 12	1316	1589	6 x 14	1595	1926	9 x 9	1504	1818
2 x 12	1162	1406	4 x 13	1379	1667	6 x 15	1657	2004	9 x 10	1569	1897
2 x 13	1225	1481	4 x 14	1442	1744	6 x 16	1721	2083	9 x 11	1630	1972
2 x 14	1291	1558	4 x 15	1509	1826	6 x 17	1787	2164	9 x 12	1699	2051
2 x 15	1354	1637	4 x 16	1573	1900	6 x 18	1853	2238	9 x 13	1759	2127
2 x 16	1419	1716	4 x 17	1636	1977	6 x 19	1914	2317	9 x 14	1822	2204
2 x 17	1481	1791	4 x 18	1699	2053	6 x 20	1977	2393	9 x 15	1886	2282
2 x 18	1546	1869	4 x 19	1762	2133				9 x 16	1953	2361
2 x 19	1611	1948	4 x 20	1830	2210	7 x 7	1224	1478	9 x 17	2017	2440
2 x 20	1676	2026				7 x 8	1287	1554	9 x 18	2080	2517
			5 x 5	943	1141	7 x 9	1351	1633	9 x 19	2143	2594
3 x 3	662	800	5 x 6	1007	1217	7 x 10	1413	1709	9 x 20	2207	2671
3 x 4	728	880	5 x 7	1070	1295	7 x 11	1478	1788			
3 x 5	789	953	5 x 8	1134	1372	7 x 12	1544	1867	10 x 10	1641	1988
3 x 6	855	1029	5 x 9	1201	1453	7 x 13	1607	1941	10 x 11	1708	2063
3 x 7	918	1113	5 x 10	1263	1526	7 x 14	1668	2020	10 x 12	1772	2144
3 x 8	982	1184	5 x 11	1327	1604	7 x 15	1734	2099	10 x 13	1835	2218
3 x 9	1046	1265	5 x 12	1391	1681	7 x 16	1799	2176	10 x 14	1898	2298
3 x 10	1111	1342	5 x 13	1454	1759	7 x 17	1862	2251	10 x 15	1965	2374
3 x 11	1173	1421	5 x 14	1520	1837	7 x 18	1926	2333	10 x 16	2029	2456
3 x 12	1240	1497	5 x 15	1581	1913	7 x 19	1992	2409	10 x 17	2091	2532
3 x 13	1302	1573	5 x 16	1649	1992	7 x 20	2053	2487	10 x 18	2155	2608
3 x 14	1367	1652	5 x 17	1709	2068				10 x 19	2221	2686
3 x 15	1431	1731	5 x 18	1776	2147	8 x 8	1363	1648	10 x 20	2286	2765
3 x 16	1495	1809	5 x 19	1839	2222	8 x 9	1427	1728			
3 x 17	1558	1881	5 x 20	1905	2301	8 x 10	1491	1804			
3 x 18	1624	1962				8 x 11	1557	1885			
3 x 19	1684	2039				8 x 12	1621	1960			
3 x 20	1751	2116				8 x 13	1684	2036			

Kits Include:

- Mill Finish or Dk. Bronze
- Cut to size and mitered bodies
- Cut to size and mitered retainers
- One vertical side will be 1-1/2" Frame (2063) with 1-1/2" Frame Cover (2073) to allow for sliding the rigid plastic faces in and out
- All screws required to assemble by mechanical fastening
- All Corner Angles and/or Corner Keys required
- Packaging

Not Included in Kits:

- Faces
- Electrical Components
- Ballast Bracket(s) - See optional accessories
- Internal Supports
- Raceway Covers and Cover Screws - See optional accessories
- Divider(s) - See optional accessories

Optional Accessories (pg 127):

- Ballast Bracket(s)
- Raceway Covers and Cover Screws
- Divider(s)

Kit Specifications:

- It is recommended to order kits 1" over nominal T12 or T8 lamp size to utilize .040 flat Aluminum Raceway Covers
- Custom size kits may be cut to any dimension
- For Rigid Plastic or Flush Aluminum Faces

Recommended Lamp Spacing:

- For illuminated backgrounds - 12" on center, using T12 or T8 lamps

Divider Kits Include:

- Cut to size dividers
- Divider Corner Angles
- All screws required to assemble by mechanical fastening
- 1-1/2" Divider, Part #2133, Mill Finish \$5.48 and Dk. Bronze \$7.14 per/ft per/face

Additional Information (pgs 196-197)

Note: It is recommended to use safety chains and prop-bars on all hingeable faces.

Unassembled Retro Kits w/ Reveal - For Rigid Faces

Retro Body w/ 2-1/4" Retainer

Part #2040
K2040/45

Part #2045

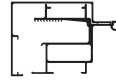
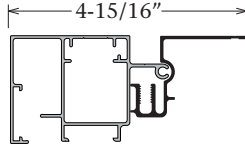

One Side Removable w/
Dual Frame, Part #2065
2-1/4" Dual Frame Cover, Part #2075

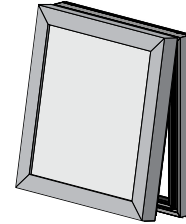

Size H'xW'	Mill Finish	Size H'xW'	Mill Finish	Size H'xW'	Mill Finish	Size H'xW'	Mill Finish
2 x 3	\$289	4 x 4	\$378	6 x 6	\$488	8 x 14	\$728
2 x 4	308	4 x 5	397	6 x 7	510	8 x 15	748
2 x 5	332	4 x 6	419	6 x 8	530	8 x 16	769
2 x 6	353	4 x 7	444	6 x 9	552	8 x 17	792
2 x 7	373	4 x 8	462	6 x 10	574	8 x 18	809
2 x 8	395	4 x 9	484	6 x 11	594	8 x 19	831
2 x 9	413	4 x 10	502	6 x 12	615	8 x 20	852
2 x 10	435	4 x 11	528	6 x 13	638		
2 x 11	456	4 x 12	546	6 x 14	655	9 x 9	655
2 x 12	475	4 x 13	567	6 x 15	677	9 x 10	677
2 x 13	496	4 x 14	587	6 x 16	697	9 x 11	694
2 x 14	519	4 x 15	610	6 x 17	720	9 x 12	717
2 x 15	542	4 x 16	629	6 x 18	742	9 x 13	745
2 x 16	563	4 x 17	651	6 x 19	762	9 x 14	762
2 x 17	581	4 x 18	670	6 x 20	783	9 x 15	784
2 x 18	602	4 x 19	692			9 x 16	805
2 x 19	623	4 x 20	710	7 x 7	547	9 x 17	825
2 x 20	643			7 x 8	567	9 x 18	847
		5 x 5	434	7 x 9	587	9 x 19	865
3 x 3	321	5 x 6	456	7 x 10	607	9 x 20	887
3 x 4	345	5 x 7	474	7 x 11	627		
3 x 5	365	5 x 8	494	7 x 12	653	10 x 10	714
3 x 6	384	5 x 9	518	7 x 13	669	10 x 11	733
3 x 7	408	5 x 10	541	7 x 14	692	10 x 12	755
3 x 8	428	5 x 11	562	7 x 15	714	10 x 13	774
3 x 9	447	5 x 12	581	7 x 16	736	10 x 14	796
3 x 10	472	5 x 13	602	7 x 17	756	10 x 15	817
3 x 11	491	5 x 14	623	7 x 18	777	10 x 16	837
3 x 12	514	5 x 15	643	7 x 19	799	10 x 17	859
3 x 13	534	5 x 16	667	7 x 20	820	10 x 18	880
3 x 14	554	5 x 17	685			10 x 19	902
3 x 15	575	5 x 18	706	8 x 8	601	10 x 20	923
3 x 16	595	5 x 19	728	8 x 9	625		
3 x 17	615	5 x 20	749	8 x 10	642		
3 x 18	638			8 x 11	664		
3 x 19	658			8 x 12	685		
3 x 20	681			8 x 13	705		

Kits Include:

- Mill Finish
- Cut to size and mitered bodies
- Cut to size and mitered retainers
- **One vertical side will be Dual Frame (2065) with 2-1/4" Dual Frame Cover (2075) to allow for sliding the rigid plastic face in and out**
- All screws required to assemble by mechanical fastening
- All Corner Angles and/or Corner Keys required
- Packaging
- Prices reflect one (1) Retro Body kit, SINGLE FACE

Not Included in Kits:

- Face
- Electrical Components
- Divider(s) - See optional accessories
- Mounting Provisions

Optional Accessories (pg 127):

- Divider(s)

Kit Specifications:

- Kits will be cut .265" larger to fit over existing structure
- Custom size kits may be cut to any dimension
- Illumination may vary depending on application
- For Rigid Plastic or Flush Aluminum Faces

Divider Kits Include:

- Cut to size dividers
- Divider Corner Angles
- All screws required to assemble by mechanical fastening
- 2" Divider, Part #2138, \$7.16 per/ft per/face
- 2-3/4" Divider, Part #2128, \$10.14 per/ft per/face

Additional Information (pgs 196-197)

Note: It is recommended to use safety chains and prop-bars on all hingeable faces.

Note: All dimensions are subject to the tolerance standards of the aluminum extrusion industry. Profile drawings are illustrative and rounded to the nearest 1/16".

CURRENT PRICE as of April 1, 2022



COMMERCIAL

Unassembled Single Face Kits w/ Reveal - For Rigid Faces

Slimline Single Face Body w/ 2-1/4" Retainer

Part #2020
K2020/45

Part #2045

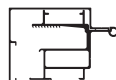
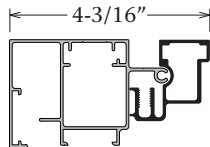

One Side Removable w/
Dual Frame, Part #2065
2-1/4" Dual Frame Cover, Part #2075

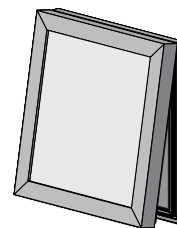

Size H'xW'	Mill Finish	Dk. Bronze	Size H'xW'	Mill Finish	Dk. Bronze	Size H'xW'	Mill Finish	Dk. Bronze	Size H'xW'	Mill Finish	Dk. Bronze
2 x 3	\$302	\$360	4 x 4	\$399	\$472	6 x 6	\$520	\$611	8 x 14	\$785	\$915
2 x 4	322	381	4 x 5	421	499	6 x 7	544	641	8 x 15	808	943
2 x 5	350	409	4 x 6	445	524	6 x 8	567	666	8 x 16	832	967
2 x 6	373	441	4 x 7	472	554	6 x 9	592	690	8 x 17	857	995
2 x 7	397	467	4 x 8	494	576	6 x 10	617	721	8 x 18	880	1025
2 x 8	421	491	4 x 9	518	606	6 x 11	639	745	8 x 19	903	1050
2 x 9	441	518	4 x 10	539	631	6 x 12	664	776	8 x 20	927	1077
2 x 10	468	546	4 x 11	567	661	6 x 13	688	801	9 x 9	704	820
2 x 11	490	570	4 x 12	590	689	6 x 14	708	827	9 x 10	728	852
2 x 12	514	598	4 x 13	613	714	6 x 15	733	856	9 x 11	748	878
2 x 13	536	627	4 x 14	637	742	6 x 16	755	880	9 x 12	773	907
2 x 14	563	654	4 x 15	658	771	6 x 17	780	912	9 x 13	804	932
2 x 15	587	681	4 x 16	682	793	6 x 18	805	936	9 x 14	824	958
2 x 16	611	706	4 x 17	706	823	6 x 19	829	964	9 x 15	849	985
2 x 17	630	736	4 x 18	729	851	6 x 20	853	990	9 x 16	872	1013
2 x 18	655	761	4 x 19	752	878	7 x 7	585	683	9 x 17	896	1038
2 x 19	678	785	4 x 20	776	903	7 x 8	606	708	9 x 18	918	1067
2 x 20	702	816				7 x 9	630	736	9 x 19	939	1092
			5 x 5	460	541	7 x 10	653	762	9 x 20	963	1121
3 x 3	337	403	5 x 6	484	567	7 x 11	676	788	10 x 10	767	896
3 x 4	364	428	5 x 7	507	597	7 x 12	702	821	10 x 11	789	918
3 x 5	387	456	5 x 8	528	623	7 x 13	721	845	10 x 12	813	947
3 x 6	408	476	5 x 9	554	651	7 x 14	748	871	10 x 13	835	976
3 x 7	434	508	5 x 10	579	674	7 x 15	773	899	10 x 14	859	1004
3 x 8	456	535	5 x 11	603	704	7 x 16	797	927	10 x 15	884	1031
3 x 9	480	563	5 x 12	626	732	7 x 17	821	953	10 x 16	907	1055
3 x 10	507	591	5 x 13	651	756	7 x 18	844	979	10 x 17	931	1082
3 x 11	528	615	5 x 14	673	781	7 x 19	869	1010	10 x 18	954	1111
3 x 12	551	643	5 x 15	697	813	7 x 20	890	1035	10 x 19	978	1134
3 x 13	576	670	5 x 16	722	839	8 x 8	645	752	10 x 20	1004	1164
3 x 14	599	694	5 x 17	745	867	8 x 9	670	778			
3 x 15	623	725	5 x 18	768	891	8 x 10	690	809			
3 x 16	645	750	5 x 19	792	916	8 x 11	714	835			
3 x 17	669	781	5 x 20	816	948	8 x 12	738	862			
3 x 18	693	805				8 x 13	761	887			
3 x 19	718	831									
3 x 20	742	860									

Kits Include:

- Mill Finish or Dk. Bronze
- Cut to size and mitered bodies
- Cut to size and mitered retainers
- One vertical side will be Dual Frame (2065) with 2-1/4" Dual Frame Cover (2075) to allow for sliding the rigid plastic face in and out
- All screws required to assemble by mechanical fastening
- All Corner Angles and/or Corner Keys required
- Packaging

Not Included in Kits:

- Face or Back
- Electrical Components
- Back Braces and Gussets
- Divider(s) - See optional accessories
- Mounting Provisions

Optional Accessories (pg 127):

- Divider(s)

Kit Specifications:

- Recommended for LED applications
- Custom size kits may be cut to any dimension
- For Rigid Plastic or Flush Aluminum Faces

Divider Kits Include:

- Cut to size dividers
- Divider Corner Angles
- All screws required to assemble by mechanical fastening
- 2" Divider, Part #2138, Mill Finish 7.16 and Dk. Bronze \$9.28 per/ft per/face
- 2-3/4" Divider, Part #2128, Mill Finish \$10.14 and Dk. Bronze \$13.24 per/ft per/face

Additional Information (pgs 196-197)

Note: It is recommended to use safety chains and prop-bars on all hingeable faces.

Unassembled Single Face Kits w/ Reveal - For Rigid Faces

Narrow Single Face Body w/ 2-1/4" Retainer

Part #2021
K2021/45

Part #2045

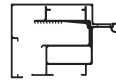
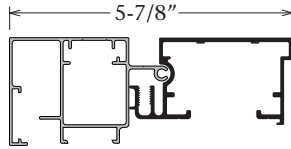

One Side Removable w/
Dual Frame, Part #2065
2-1/4" Dual Frame Cover, Part #2075

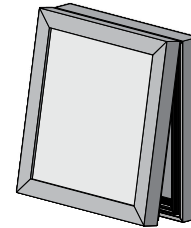

Size H'xW'	Mill Finish	Dk. Bronze	Size H'xW'	Mill Finish	Dk. Bronze	Size H'xW'	Mill Finish	Dk. Bronze	Size H'xW'	Mill Finish	Dk. Bronze
2 x 3	\$332	\$399	4 x 4	\$445	\$538	6 x 6	\$591	\$708	8 x 14	\$915	\$1095
2 x 4	360	431	4 x 5	474	571	6 x 7	621	746	8 x 15	943	1132
2 x 5	389	467	4 x 6	506	607	6 x 8	649	780	8 x 16	975	1164
2 x 6	421	507	4 x 7	538	645	6 x 9	681	812	8 x 17	1006	1201
2 x 7	450	539	4 x 8	564	674	6 x 10	709	852	8 x 18	1034	1237
2 x 8	480	574	4 x 9	594	710	6 x 11	738	883	8 x 19	1063	1269
2 x 9	507	607	4 x 10	622	748	6 x 12	769	923	8 x 20	1092	1304
2 x 10	538	643	4 x 11	655	783	6 x 13	799	958	9 x 9	809	966
2 x 11	566	676	4 x 12	682	820	6 x 14	827	990	9 x 10	839	1007
2 x 12	595	714	4 x 13	710	852	6 x 15	856	1027	9 x 11	865	1041
2 x 13	625	750	4 x 14	742	888	6 x 16	884	1060	9 x 12	896	1079
2 x 14	655	784	4 x 15	771	927	6 x 17	915	1100	9 x 13	932	1113
2 x 15	688	820	4 x 16	800	956	6 x 18	947	1133	9 x 14	959	1145
2 x 16	717	855	4 x 17	829	992	6 x 19	978	1170	9 x 15	990	1181
2 x 17	744	891	4 x 18	857	1030	6 x 20	1007	1202	9 x 16	1019	1218
2 x 18	774	924	4 x 19	887	1066	7 x 7	667	799	9 x 17	1050	1251
2 x 19	801	958	4 x 20	916	1098	7 x 8	694	831	9 x 18	1079	1288
2 x 20	831	995				7 x 9	724	867	9 x 19	1106	1320
			5 x 5	519	623	7 x 10	752	902	9 x 20	1136	1360
			5 x 6	548	657	7 x 11	781	935			
			5 x 7	576	694	7 x 12	813	976	10 x 10	884	1058
			5 x 8	603	729	7 x 13	839	1009	10 x 11	912	1089
			5 x 9	638	767	7 x 14	871	1041	10 x 12	943	1128
			5 x 10	669	797	7 x 15	902	1079	10 x 13	969	1164
			5 x 11	698	835	7 x 16	932	1114	10 x 14	1002	1199
			5 x 12	725	871	7 x 17	962	1148	10 x 15	1031	1237
			5 x 13	756	904	7 x 18	991	1184	10 x 16	1061	1268
			5 x 14	784	936	7 x 19	1022	1223	10 x 17	1090	1302
			5 x 15	813	978	7 x 20	1051	1255	10 x 18	1120	1340
			5 x 16	845	1010				10 x 19	1149	1372
			5 x 17	874	1046	8 x 8	738	883	10 x 20	1181	1409
			5 x 18	903	1081	8 x 9	769	916			
			5 x 19	932	1113	8 x 10	796	958			
			5 x 20	963	1153	8 x 11	825	990			
						8 x 12	856	1026			
						8 x 13	884	1058			

Kits Include:

- Mill Finish or Dk. Bronze
- Cut to size and mitered bodies
- Cut to size and mitered retainers
- One vertical side will be Dual Frame (2065) with 2-1/4" Dual Frame Cover (2075) to allow for sliding the rigid plastic face in and out
- All screws required to assemble by mechanical fastening
- All Corner Angles and/or Corner Keys required
- Packaging

Not Included in Kits:

- Face or Back
- Electrical Components
- Back Braces and Gussets
- Divider(s) - See optional accessories
- 6" Radius Corners - See optional accessories
- Mounting Provisions

Optional Accessories (pgs 127-128):

- Divider(s)
- 6" Radius Corners

Kit Specifications:

- Recommended for LED applications
- Custom size kits may be cut to any dimension
- For Rigid Plastic or Flush Aluminum Faces

Divider Kits Include:

- Cut to size dividers
- Divider Corner Angles
- All screws required to assemble by mechanical fastening
- 2" Divider, Part #2138, Mill Finish \$7.16 and Dk. Bronze \$9.28 per/ft per/face
- 2-3/4" Divider, Part #2128, Mill Finish \$10.14 and Dk. Bronze \$13.24 per/ft per/face

Additional Information (pgs 196-197)

Note: It is recommended to use safety chains and prop-bars on all hingeable faces.

Note: All dimensions are subject to the tolerance standards of the aluminum extrusion industry. Profile drawings are illustrative and rounded to the nearest 1/16".

CURRENT PRICE as of April 1, 2022



COMMERCIAL

Unassembled Single Face Kits w/ Reveal - For Rigid Faces

Single Face Body w/ 2-1/4" Retainer

Part #2025
KSF/45

Part #2045

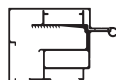
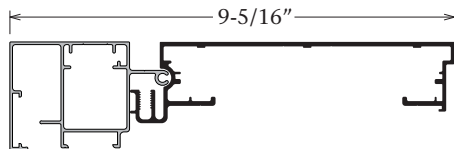

One Side Removable w/
Dual Frame, Part #2065
2-1/4" Dual Frame Cover, Part #2075

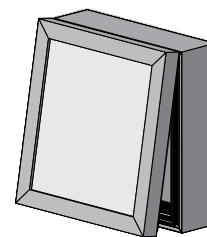

Size H'xW'	Mill Finish	Dk. Bronze	Size H'xW'	Mill Finish	Dk. Bronze	Size H'xW'	Mill Finish	Dk. Bronze	Size H'xW'	Mill Finish	Dk. Bronze
2 x 3	\$346	\$421	4 x 4	\$471	\$571	6 x 6	\$627	\$760	8 x 14	\$983	\$1189
2 x 4	378	456	4 x 5	502	611	6 x 7	661	801	8 x 15	1014	1228
2 x 5	412	495	4 x 6	536	649	6 x 8	693	839	8 x 16	1050	1267
2 x 6	445	541	4 x 7	571	692	6 x 9	728	876	8 x 17	1082	1306
2 x 7	478	578	4 x 8	601	725	6 x 10	760	920	8 x 18	1113	1347
2 x 8	511	615	4 x 9	633	768	6 x 11	792	956	8 x 19	1145	1384
2 x 9	541	654	4 x 10	666	807	6 x 12	825	999	8 x 20	1177	1425
2 x 10	575	694	4 x 11	702	847	6 x 13	857	1038			
2 x 11	606	732	4 x 12	732	887	6 x 14	888	1076	9 x 9	865	1042
2 x 12	639	773	4 x 13	765	924	6 x 15	922	1117	9 x 10	899	1088
2 x 13	671	813	4 x 14	797	964	6 x 16	953	1153	9 x 11	928	1128
2 x 14	705	853	4 x 15	829	1007	6 x 17	987	1197	9 x 12	960	1168
2 x 15	740	891	4 x 16	862	1041	6 x 18	1021	1236	9 x 13	1002	1207
2 x 16	773	931	4 x 17	896	1083	6 x 19	1054	1275	9 x 14	1030	1243
2 x 17	801	974	4 x 18	927	1122	6 x 20	1086	1314	9 x 15	1065	1284
2 x 18	836	1010	4 x 19	959	1164				9 x 16	1095	1324
2 x 19	867	1046	4 x 20	991	1201	7 x 7	709	857	9 x 17	1129	1362
2 x 20	900	1089				7 x 8	742	896	9 x 18	1161	1403
			5 x 5	550	666	7 x 9	774	935	9 x 19	1192	1441
3 x 3	392	476	5 x 6	583	704	7 x 10	805	975	9 x 20	1224	1482
3 x 4	425	515	5 x 7	614	746	7 x 11	837	1011			
3 x 5	459	554	5 x 8	645	784	7 x 12	874	1057	10 x 10	947	1144
3 x 6	488	590	5 x 9	681	825	7 x 13	902	1094	10 x 11	978	1180
3 x 7	523	631	5 x 10	716	860	7 x 14	935	1132	10 x 12	1011	1220
3 x 8	554	671	5 x 11	748	903	7 x 15	969	1172	10 x 13	1041	1263
3 x 9	587	710	5 x 12	778	943	7 x 16	1004	1212	10 x 14	1076	1302
3 x 10	623	752	5 x 13	812	981	7 x 17	1037	1251	10 x 15	1109	1343
3 x 11	654	789	5 x 14	844	1018	7 x 18	1067	1290	10 x 16	1141	1378
3 x 12	688	829	5 x 15	876	1063	7 x 19	1102	1332	10 x 17	1173	1418
3 x 13	720	869	5 x 16	911	1100	7 x 20	1133	1371	10 x 18	1207	1458
3 x 14	752	906	5 x 17	842	1141				10 x 19	1239	1495
3 x 15	784	950	5 x 18	975	1177	8 x 8	788	951	10 x 20	1272	1537
3 x 16	816	987	5 x 19	1007	1216	8 x 9	823	990			
3 x 17	849	1030	5 x 20	1039	1259	8 x 10	852	1034			
3 x 18	881	1066				8 x 11	884	1070			
3 x 19	915	1105				8 x 12	918	1111			
3 x 20	948	1146				8 x 13	950	1148			

Kits Include:

- Mill Finish or Dk. Bronze
- Cut to size and mitered bodies
- Cut to size and mitered retainers
- One vertical side will be Dual Frame (2065) with 2-1/4" Dual Frame Cover (2075) to allow for sliding the rigid plastic face in and out
- All screws required to assemble by mechanical fastening
- All Corner Angles and/or Corner Keys required
- Packaging

Not Included in Kits:

- Face or Back
- Electrical Components
- Ballast Bracket(s) - See optional accessories
- Back Braces and Gussets
- Raceway Covers and Cover Screws - See optional accessories
- Divider(s) - See optional accessories
- 6" and 9" Radius Corners - See optional accessories
- Mounting Provisions

Optional Accessories (pgs 127-128):

- Ballast Bracket(s)
- Raceway Covers and Cover Screws
- Divider(s)
- 6" and 9" Radius Corners

Kit Specifications:

- It is recommended to order kits 1" over nominal T12 or T8 lamp size to utilize .040 flat Aluminum Raceway Covers
- Custom size kits may be cut to any dimension
- For Rigid Plastic or Flush Aluminum Faces

Recommended Lamp Spacing:

- For illuminated backgrounds - 12" on center, using T12 or T8 lamps
- Always place lamps 3/4" from back of sign

Divider Kits Include:

- Cut to size dividers
- Divider Corner Angles
- All screws required to assemble by mechanical fastening
- 2" Divider, Part #2138, Mill Finish \$7.16 and Dk. Bronze \$9.28 per/ft per/face
- 2-3/4" Divider, Part #2128, Mill Finish \$10.14 and Dk. Bronze \$13.24 per/ft per/face

Additional Information (pgs 196-197)

Note: It is recommended to use safety chains and prop-bars on all hingeable faces.

Unassembled Double Face Kits w/ Reveal - For Rigid Faces

Medium Body w/ 2-1/4" Retainer

Part #2015
KMB/45

Part #2045

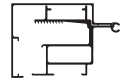
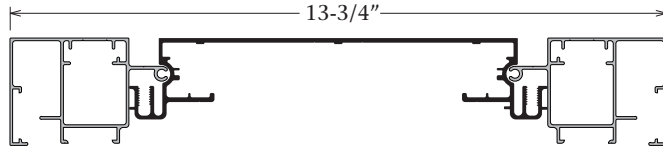

One Side Removable w/
Dual Frame, Part #2065
2-1/4" Dual Frame Cover, Part #2075

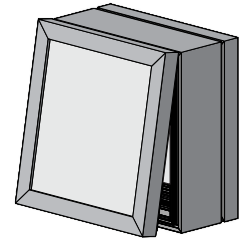

Size H'xW'	Mill Finish	Dk. Bronze	Size H'xW'	Mill Finish	Dk. Bronze	Size H'xW'	Mill Finish	Dk. Bronze	Size H'xW'	Mill Finish	Dk. Bronze
2 x 3	\$536	\$649	4 x 4	\$746	\$900	6 x 6	\$1004	\$1212	8 x 14	\$1560	\$1890
2 x 4	585	708	4 x 5	795	959	6 x 7	1051	1269	8 x 15	1611	1953
2 x 5	633	768	4 x 6	845	1019	6 x 8	1104	1335	8 x 16	1661	2012
2 x 6	688	829	4 x 7	895	1082	6 x 9	1150	1394	8 x 17	1711	2073
2 x 7	738	888	4 x 8	947	1144	6 x 10	1205	1457	8 x 18	1762	2131
2 x 8	788	951	4 x 9	998	1202	6 x 11	1248	1516	8 x 19	1809	2190
2 x 9	836	1010	4 x 10	1042	1264	6 x 12	1302	1577	8 x 20	1863	2251
2 x 10	887	1071	4 x 11	1095	1324	6 x 13	1351	1636			
2 x 11	935	1132	4 x 12	1145	1384	6 x 14	1402	1693	9 x 9	1390	1681
2 x 12	987	1197	4 x 13	1195	1446	6 x 15	1453	1759	9 x 10	1438	1739
2 x 13	1038	1253	4 x 14	1243	1505	6 x 16	1502	1821	9 x 11	1488	1799
2 x 14	1086	1314	4 x 15	1297	1569	6 x 17	1556	1877	9 x 12	1540	1865
2 x 15	1137	1376	4 x 16	1346	1625	6 x 18	1605	1937	9 x 13	1589	1923
2 x 16	1189	1439	4 x 17	1397	1688	6 x 19	1655	1998	9 x 14	1639	1984
2 x 17	1239	1495	4 x 18	1447	1751	6 x 20	1703	2060	9 x 15	1691	2045
2 x 18	1291	1558	4 x 19	1497	1806				9 x 16	1739	2103
2 x 19	1342	1621	4 x 20	1550	1869	7 x 7	1130	1367	9 x 17	1790	2165
2 x 20	1390	1681				7 x 8	1180	1427	9 x 18	1841	2226
			5 x 5	874	1057	7 x 9	1233	1491	9 x 19	1894	2287
3 x 3	614	746	5 x 6	922	1117	7 x 10	1279	1550	9 x 20	1938	2347
3 x 4	662	804	5 x 7	974	1174	7 x 11	1330	1608			
3 x 5	718	862	5 x 8	1025	1239	7 x 12	1381	1671	10 x 10	1518	1834
3 x 6	765	924	5 x 9	1073	1297	7 x 13	1431	1731	10 x 11	1565	1895
3 x 7	813	985	5 x 10	1121	1356	7 x 14	1481	1793	10 x 12	1620	1958
3 x 8	865	1042	5 x 11	1173	1418	7 x 15	1530	1853	10 x 13	1668	2018
3 x 9	916	1109	5 x 12	1224	1482	7 x 16	1585	1914	10 x 14	1716	2076
3 x 10	963	1170	5 x 13	1274	1538	7 x 17	1635	1972	10 x 15	1767	2139
3 x 11	1014	1228	5 x 14	1325	1598	7 x 18	1683	2036	10 x 16	1818	2198
3 x 12	1067	1290	5 x 15	1375	1663	7 x 19	1732	2096	10 x 17	1869	2259
3 x 13	1116	1348	5 x 16	1423	1719	7 x 20	1782	2156	10 x 18	1921	2319
3 x 14	1168	1410	5 x 17	1474	1786				10 x 19	1968	2382
3 x 15	1213	1471	5 x 18	1525	1844	8 x 8	1264	1525	10 x 20	2018	2441
3 x 16	1268	1532	5 x 19	1577	1906	8 x 9	1311	1584			
3 x 17	1318	1593	5 x 20	1624	1965	8 x 10	1360	1644			
3 x 18	1367	1653				8 x 11	1410	1705			
3 x 19	1418	1714				8 x 12	1462	1764			
3 x 20	1466	1772				8 x 13	1509	1828			

Kits Include:

- Mill Finish or Dk. Bronze
- Cut to size and mitered bodies
- Cut to size and mitered retainers
- One vertical side will be Dual Frame (2065) with 2-1/4" Dual Frame Cover (2075) to allow for sliding the rigid plastic faces in and out
- All screws required to assemble by mechanical fastening
- All Corner Angles and/or Corner Keys required
- Packaging

Not Included in Kits:

- Faces
- Electrical Components
- Ballast Bracket(s) - See optional accessories
- Internal Supports
- Raceway Covers and Cover Screws - See optional accessories
- Divider(s) - See optional accessories
- 6" and 9" Radius Corners - See optional accessories

Optional Accessories (pgs 127-128):

- Ballast Bracket(s)
- Raceway Covers and Cover Screws
- Divider(s)
- 6" and 9" Radius Corners

Kit Specifications:

- It is recommended to order kits 1" over nominal T12 or T8 lamp size to utilize .040 flat Aluminum Raceway Covers
- Custom size kits may be cut to any dimension
- For Rigid Plastic or Flush Aluminum Faces

Recommended Lamp Spacing:

- For illuminated backgrounds - 10" on center, using T12 or T8 lamps

Divider Kits Include:

- Cut to size dividers
- Divider Corner Angles
- All screws required to assemble by mechanical fastening
- 2" Divider, Part #2138, Mill Finish \$7.16 and Dk. Bronze \$9.28 per/ft per/face
- 2-3/4" Divider, Part #2128, Mill Finish \$10.14 and Dk. Bronze \$13.24 per/ft per/face

Additional Information (pgs 196-197)

Note: It is recommended to use safety chains and prop-bars on all hingeable faces.

Unassembled Retro Kits w/ Reveal - For Rigid or Flexible Faces

Retro Body w/ Dual Frame and 2-1/4" Dual Frame Cover

Part #2040
K2040/65

Part #2065

Part #2075

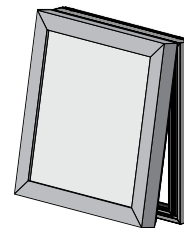
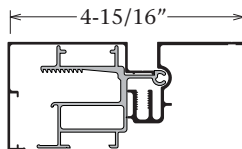

Size H'xW'	Mill Finish	Size H'xW'	Mill Finish	Size H'xW'	Mill Finish	Size H'xW'	Mill Finish
2 x 3	\$380	4 x 4	\$485	6 x 6	\$657	8 x 14	\$1074
2 x 4	413	4 x 5	523	6 x 7	709	8 x 15	1114
2 x 5	450	4 x 6	571	6 x 8	742	8 x 16	1148
2 x 6	500	4 x 7	623	6 x 9	783	8 x 17	1197
2 x 7	548	4 x 8	657	6 x 10	831	8 x 18	1235
2 x 8	583	4 x 9	699	6 x 11	869	8 x 19	1285
2 x 9	625	4 x 10	746	6 x 12	906	8 x 20	1324
2 x 10	674	4 x 11	783	6 x 13	956		
2 x 11	710	4 x 12	823	6 x 14	990	9 x 9	906
2 x 12	750	4 x 13	872	6 x 15	1029	9 x 10	951
2 x 13	799	4 x 14	906	6 x 16	1081	9 x 11	990
2 x 14	832	4 x 15	947	6 x 17	1117	9 x 12	1026
2 x 15	875	4 x 16	995	6 x 18	1156	9 x 13	1079
2 x 16	922	4 x 17	1029	6 x 19	1204	9 x 14	1111
2 x 17	959	4 x 18	1070	6 x 20	1239	9 x 15	1152
2 x 18	997	4 x 19	1121			9 x 16	1197
2 x 19	1043	4 x 20	1156	7 x 7	758	9 x 17	1235
2 x 20	1082			7 x 8	792	9 x 18	1272
		5 x 5	560	7 x 9	832	9 x 19	1325
3 x 3	416	5 x 6	611	7 x 10	881	9 x 20	1363
3 x 4	455	5 x 7	661	7 x 11	918		
3 x 5	490	5 x 8	697	7 x 12	956	10 x 10	998
3 x 6	539	5 x 9	734	7 x 13	1003	10 x 11	1035
3 x 7	587	5 x 10	783	7 x 14	1038	10 x 12	1074
3 x 8	625	5 x 11	821	7 x 15	1081	10 x 13	1121
3 x 9	666	5 x 12	859	7 x 16	1126	10 x 14	1156
3 x 10	713	5 x 13	907	7 x 17	1164	10 x 15	1196
3 x 11	750	5 x 14	944	7 x 18	1199	10 x 16	1243
3 x 12	788	5 x 15	983	7 x 19	1252	10 x 17	1283
3 x 13	836	5 x 16	1027	7 x 20	1285	10 x 18	1323
3 x 14	872	5 x 17	1069			10 x 19	1375
3 x 15	912	5 x 18	1105	8 x 8	823	10 x 20	1403
3 x 16	959	5 x 19	1157	8 x 9	867		
3 x 17	997	5 x 20	1188	8 x 10	903		
3 x 18	1037			8 x 11	950		
3 x 19	1086			8 x 12	988		
3 x 20	1122			8 x 13	1025		

Kits Include:

- Mill Finish
- Cut to size and mitered bodies
- Cut to size and mitered frames with covers
- Tension Clips
- Frame Braces for LED applications (Part #5357)
- All screws required to assemble by mechanical fastening
- All Corner Angles and/or Corner Keys required
- Packaging
- Prices reflect one (1) Retro Body kit, SINGLE FACE APPLICATION

Not Included in Kits:

- Face
- Electrical Components
- Frame Support Tube - See optional accessories
- Divider(s) - See optional accessories
- Tension Tool - See optional accessories
- Mounting Provisions

Optional Accessories (pg 127):

- Frame Support Tube
- Divider(s)
- Tension Tool

Kit Specifications:

- Kits will be cut .265" larger to fit over existing structure
- Custom size kits may be cut to any dimension
- Illumination may vary depending on application
- Flexible Face Preparation - See page 129
- Frame Brace / Frame Support Tube placement - See page 130

Divider Kits Include:

- Cut to size dividers
- Divider Corner Angles
- All screws required to assemble by mechanical fastening
- Tension Clips
- Dual Divider and 2-1/2" Dual Divider Cover, Parts #2142 and #2146, \$15.00 per/ft per/face

Additional Information (pgs 196-197)

Note: All dimensions are subject to the tolerance standards of the aluminum extrusion industry. Profile drawings are illustrative and rounded to the nearest 1/16".

CURRENT PRICE as of April 1, 2022



COMMERCIAL

Unassembled Single Face Kits w/ Reveal - For Rigid or Flexible Faces

Slimline Single Face Body w/ Dual Frame and 2-1/4" Dual Frame Cover

Part #2020
K2020/65

Part #2065

Part #2075

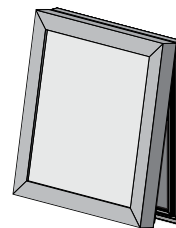
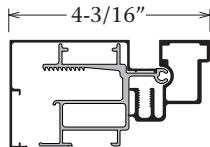

Size H'xW'	Mill Finish	Dk. Bronze	Size H'xW'	Mill Finish	Dk. Bronze	Size H'xW'	Mill Finish	Dk. Bronze	Size H'xW'	Mill Finish	Dk. Bronze
2 x 3	\$392	\$463	4 x 4	\$507	\$599	6 x 6	\$667	\$785	8 x 14	\$1061	\$1247
2 x 4	429	510	4 x 5	547	648	6 x 7	706	835	8 x 15	1104	1297
2 x 5	469	559	4 x 6	586	693	6 x 8	744	881	8 x 16	1138	1343
2 x 6	510	602	4 x 7	627	740	6 x 9	784	927	8 x 17	1181	1390
2 x 7	548	649	4 x 8	667	785	6 x 10	827	974	8 x 18	1221	1438
2 x 8	586	693	4 x 9	709	839	6 x 11	865	1021	8 x 19	1260	1485
2 x 9	629	748	4 x 10	748	883	6 x 12	906	1066	8 x 20	1302	1526
2 x 10	670	789	4 x 11	784	927	6 x 13	944	1113	9 x 9	906	1066
2 x 11	708	837	4 x 12	829	976	6 x 14	982	1157	9 x 10	942	1111
2 x 12	750	888	4 x 13	869	1025	6 x 15	1026	1211	9 x 11	982	1157
2 x 13	789	932	4 x 14	906	1066	6 x 16	1067	1255	9 x 12	1022	1202
2 x 14	828	975	4 x 15	948	1116	6 x 17	1106	1300	9 x 13	1066	1251
2 x 15	872	1027	4 x 16	988	1162	6 x 18	1146	1350	9 x 14	1100	1295
2 x 16	911	1070	4 x 17	1026	1211	6 x 19	1188	1394	9 x 15	1144	1346
2 x 17	948	1116	4 x 18	1069	1257	6 x 20	1224	1439	9 x 16	1181	1390
2 x 18	990	1164	4 x 19	1110	1304	7 x 7	748	883	9 x 17	1221	1438
2 x 19	1027	1212	4 x 20	1146	1350	7 x 8	781	922	9 x 18	1260	1485
2 x 20	1069	1257				7 x 9	828	975	9 x 19	1303	1529
			5 x 5	586	693	7 x 10	865	1021	9 x 20	1343	1574
3 x 3	432	514	5 x 6	627	740	7 x 11	906	1066	10 x 10	979	1153
3 x 4	472	560	5 x 7	670	789	7 x 12	944	1113	10 x 11	1019	1199
3 x 5	511	603	5 x 8	706	835	7 x 13	983	1161	10 x 12	1061	1247
3 x 6	551	653	5 x 9	749	884	7 x 14	1022	1202	10 x 13	1098	1293
3 x 7	591	701	5 x 10	784	927	7 x 15	1067	1255	10 x 14	1136	1339
3 x 8	629	748	5 x 11	828	975	7 x 16	1104	1297	10 x 15	1180	1388
3 x 9	674	796	5 x 12	867	1022	7 x 17	1144	1346	10 x 16	1217	1432
3 x 10	709	839	5 x 13	907	1067	7 x 18	1183	1393	10 x 17	1257	1481
3 x 11	750	888	5 x 14	944	1113	7 x 19	1224	1439	10 x 18	1300	1525
3 x 12	789	932	5 x 15	988	1162	7 x 20	1260	1485	10 x 19	1343	1574
3 x 13	831	979	5 x 16	1025	1208	8 x 8	817	969	10 x 20	1375	1616
3 x 14	869	1025	5 x 17	1067	1255	8 x 9	862	1018			
3 x 15	912	1073	5 x 18	1106	1300	8 x 10	903	1060			
3 x 16	948	1116	5 x 19	1148	1351	8 x 11	939	1109			
3 x 17	990	1164	5 x 20	1183	1393	8 x 12	981	1156			
3 x 18	1031	1216				8 x 13	1021	1201			
3 x 19	1073	1263									
3 x 20	1111	1306									

Kits Include:

- Mill Finish or Dk. Bronze
- Cut to size and mitered bodies
- Cut to size and mitered frames with covers
- Tension Clips
- Frame Braces (Part #5352)
- All screws required to assemble by mechanical fastening
- All Corner Angles and/or Corner Keys required
- Packaging

Not Included in Kits:

- Face or Back
- Electrical Components
- Back Braces and Gussets
- Frame Support Tube - See optional accessories
- Divider(s) - See optional accessories
- Tension Tool - See optional accessories
- Mounting Provisions

Optional Accessories (pg 127):

- Frame Support Tube
- Divider(s)
- Tension Tool

Kit Specifications:

- Recommended for LED applications
- Custom size kits may be cut to any dimension
- Flexible Face Preparation - See page 129
- Frame Brace / Frame Support Tube placement - See page 130

Divider Kits Include:

- Cut to size dividers
- Divider Corner Angles
- All screws required to assemble by mechanical fastening
- Tension Clips
- Dual Divider and 2-1/2" Dual Divider Cover, Parts #2142 and #2146, Mill Finish \$15.33 and Dk. Bronze \$18.54 per/ft per/face

Additional Information (pgs 196-197)

UL Recognized Component Systems
The Underwriters Laboratory file number is E136850

Note: It is recommended to use safety chains and prop-bars on all hingeable faces.

US Patent Numbers 6,061,941 / 6,637,080
CA Patent Numbers 2,245,623 / 2,387,222

Unassembled Single Face Kits w/ Reveal - For Rigid or Flexible Faces

Narrow Single Face Body w/ Dual Frame and 2-1/4" Dual Frame Cover

Part #2021
K2021/65

Part #2065

Part #2075

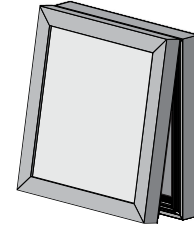
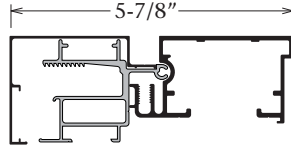

Size H'xW'	Mill Finish	Dk. Bronze	Size H'xW'	Mill Finish	Dk. Bronze	Size H'xW'	Mill Finish	Dk. Bronze	Size H'xW'	Mill Finish	Dk. Bronze
2 x 3	\$421	\$503	4 x 4	\$552	\$666	6 x 6	\$736	\$884	8 x 14	\$1190	\$1426
2 x 4	464	560	4 x 5	599	721	6 x 7	783	939	8 x 15	1239	1485
2 x 5	510	615	4 x 6	645	776	6 x 8	825	995	8 x 16	1280	1538
2 x 6	555	669	4 x 7	693	829	6 x 9	874	1050	8 x 17	1328	1595
2 x 7	601	722	4 x 8	736	884	6 x 10	920	1104	8 x 18	1375	1651
2 x 8	645	776	4 x 9	785	944	6 x 11	964	1160	8 x 19	1421	1707
2 x 9	694	837	4 x 10	829	998	6 x 12	1011	1213	8 x 20	1469	1755
2 x 10	740	887	4 x 11	874	1050	6 x 13	1057	1268			
2 x 11	784	943	4 x 12	923	1106	6 x 14	1100	1319	9 x 9	1011	1213
2 x 12	832	1004	4 x 13	967	1162	6 x 15	1148	1381	9 x 10	1054	1267
2 x 13	878	1055	4 x 14	1011	1213	6 x 16	1196	1435	9 x 11	1100	1319
2 x 14	922	1105	4 x 15	1060	1271	6 x 17	1241	1488	9 x 12	1145	1374
2 x 15	972	1165	4 x 16	1106	1325	6 x 18	1288	1546	9 x 13	1195	1431
2 x 16	1015	1218	4 x 17	1148	1381	6 x 19	1335	1600	9 x 14	1236	1482
2 x 17	1060	1271	4 x 18	1197	1438	6 x 20	1378	1652	9 x 15	1285	1542
2 x 18	1109	1327	4 x 19	1244	1494				9 x 16	1328	1595
2 x 19	1149	1382	4 x 20	1288	1546	7 x 7	829	998	9 x 17	1375	1651
2 x 20	1197	1438				7 x 8	871	1043	9 x 18	1421	1707
			5 x 5	645	776	7 x 9	922	1105	9 x 19	1470	1758
3 x 3	468	563	5 x 6	693	829	7 x 10	964	1160	9 x 20	1516	1812
3 x 4	514	617	5 x 7	740	887	7 x 11	1011	1213			
3 x 5	559	670	5 x 8	783	939	7 x 12	1057	1268	10 x 10	1097	1316
3 x 6	603	725	5 x 9	831	999	7 x 13	1102	1324	10 x 11	1142	1371
3 x 7	649	783	5 x 10	874	1050	7 x 14	1145	1374	10 x 12	1190	1426
3 x 8	694	837	5 x 11	922	1105	7 x 15	1196	1435	10 x 13	1235	1481
3 x 9	745	895	5 x 12	966	1161	7 x 16	1239	1485	10 x 14	1277	1533
3 x 10	785	944	5 x 13	1013	1216	7 x 17	1285	1542	10 x 15	1327	1593
3 x 11	832	1004	5 x 14	1057	1268	7 x 18	1330	1598	10 x 16	1371	1647
3 x 12	878	1055	5 x 15	1106	1325	7 x 19	1378	1652	10 x 17	1418	1702
3 x 13	924	1110	5 x 16	1146	1378	7 x 20	1421	1707	10 x 18	1467	1754
3 x 14	967	1162	5 x 17	1196	1435				10 x 19	1516	1812
3 x 15	1018	1221	5 x 18	1241	1488	8 x 8	911	1100	10 x 20	1553	1862
3 x 16	1060	1271	5 x 19	1290	1548	8 x 9	962	1157			
3 x 17	1109	1327	5 x 20	1330	1598	8 x 10	1009	1208			
3 x 18	1156	1387				8 x 11	1053	1264			
3 x 19	1202	1442				8 x 12	1098	1318			
3 x 20	1247	1495				8 x 13	1144	1372			

Kits Include:

- Mill Finish or Dk. Bronze
- Cut to size and mitered bodies
- Cut to size and mitered frames with covers
- Tension Clips
- Frame Braces (Part #5350)
- All screws required to assemble by mechanical fastening
- All Corner Angles and/or Corner Keys required
- Packaging

Not Included in Kits:

- Face or Back
- Electrical Components
- Back Braces and Gussets
- Frame Support Tube - See optional accessories
- Divider(s)
- 6" Radius Corners - See optional accessories
- Tension Tool - See optional accessories
- Mounting Provisions

Optional Accessories (pgs 127-128):

- Frame Support Tube
- Divider(s)
- 6" Radius Corners
- Tension Tool

Kit Specifications:

- Recommended for LED applications
- Custom size kits may be cut to any dimension
- Flexible Face Preparation - See page 129
- Frame Brace / Frame Support Tube placement - See page 130

Divider Kits Include:

- Cut to size dividers
- Divider Corner Angles
- All screws required to assemble by mechanical fastening
- Tension Clips
- Dual Divider and 2-1/2" Dual Divider Cover, Parts #2142 and #2146, Mill Finish \$15.33 and Dk. Bronze \$18.54 per/ft per/face

Additional Information (pgs 196-197)

Note: All dimensions are subject to the tolerance standards of the aluminum extrusion industry. Profile drawings are illustrative and rounded to the nearest 1/16".

CURRENT PRICE as of April 1, 2022



COMMERCIAL

Unassembled Single Face Kits w/ Reveal - For Rigid or Flexible Faces

Single Face Body w/ Dual Frame and 2-1/4" Dual Frame Cover

Part #2025
KSF/65

Part #2065

Part #2075

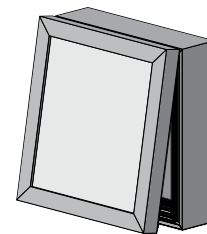
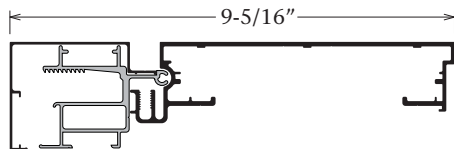

Size H'xW'	Mill Finish	Dk. Bronze	Size H'xW'	Mill Finish	Dk. Bronze	Size H'xW'	Mill Finish	Dk. Bronze	Size H'xW'	Mill Finish	Dk. Bronze
2 x 3	\$437	\$524	4 x 4	\$578	\$699	6 x 6	\$797	\$959	8 x 14	\$1331	\$1592
2 x 4	484	585	4 x 5	627	760	6 x 7	860	1031	8 x 15	1382	1655
2 x 5	532	645	4 x 6	688	829	6 x 8	906	1092	8 x 16	1426	1712
2 x 6	592	714	4 x 7	750	900	6 x 9	958	1149	8 x 17	1488	1784
2 x 7	653	784	4 x 8	797	959	6 x 10	1018	1220	8 x 18	1538	1844
2 x 8	699	841	4 x 9	851	1025	6 x 11	1066	1281	8 x 19	1600	1917
2 x 9	752	907	4 x 10	911	1094	6 x 12	1116	1339	8 x 20	1651	1970
2 x 10	813	975	4 x 11	958	1149	6 x 13	1176	1409	9 x 9	1116	1339
2 x 11	862	1037	4 x 12	1010	1211	6 x 14	1223	1465	9 x 10	1173	1407
2 x 12	914	1100	4 x 13	1069	1284	6 x 15	1274	1532	9 x 11	1223	1465
2 x 13	974	1167	4 x 14	1116	1339	6 x 16	1336	1601	9 x 12	1271	1525
2 x 14	1021	1221	4 x 15	1167	1400	6 x 17	1386	1657	9 x 13	1335	1596
2 x 15	1073	1287	4 x 16	1228	1470	6 x 18	1435	1721	9 x 14	1378	1652
2 x 16	1132	1355	4 x 17	1274	1532	6 x 19	1494	1788	9 x 15	1432	1715
2 x 17	1178	1411	4 x 18	1327	1590	6 x 20	1541	1846	9 x 16	1488	1784
2 x 18	1229	1473	4 x 19	1388	1663	7 x 7	922	1105	9 x 17	1538	1844
2 x 19	1287	1545	4 x 20	1435	1721	7 x 8	964	1157	9 x 18	1586	1905
2 x 20	1339	1602				7 x 9	1021	1221	9 x 19	1652	1973
			5 x 5	676	817	7 x 10	1077	1293	9 x 20	1700	2032
3 x 3	487	587	5 x 6	738	888	7 x 11	1128	1350	10 x 10	1232	1473
3 x 4	535	646	5 x 7	800	962	7 x 12	1176	1409	10 x 11	1280	1532
3 x 5	583	704	5 x 8	847	1019	7 x 13	1236	1481	10 x 12	1331	1592
3 x 6	643	777	5 x 9	899	1082	7 x 14	1283	1537	10 x 13	1388	1663
3 x 7	704	849	5 x 10	958	1149	7 x 15	1336	1601	10 x 14	1435	1719
3 x 8	752	907	5 x 11	1009	1209	7 x 16	1394	1667	10 x 15	1486	1783
3 x 9	805	967	5 x 12	1055	1271	7 x 17	1443	1727	10 x 16	1546	1853
3 x 10	863	1038	5 x 13	1117	1340	7 x 18	1489	1787	10 x 17	1596	1913
3 x 11	914	1100	5 x 14	1164	1397	7 x 19	1554	1859	10 x 18	1649	1969
3 x 12	962	1156	5 x 15	1217	1458	7 x 20	1600	1917	10 x 19	1712	2044
3 x 13	1023	1225	5 x 16	1272	1529	8 x 8	1009	1217	10 x 20	1752	2097
3 x 14	1069	1284	5 x 17	1325	1589	8 x 9	1063	1277			
3 x 15	1121	1346	5 x 18	1374	1647	8 x 10	1113	1332			
3 x 16	1178	1411	5 x 19	1437	1723	8 x 11	1172	1404			
3 x 17	1229	1473	5 x 20	1478	1775	8 x 12	1221	1463			
3 x 18	1280	1537				8 x 13	1269	1522			
3 x 19	1343	1607									
3 x 20	1390	1665									

Kits Include:

- Mill Finish or Dk. Bronze
- Cut to size and mitered bodies
- Cut to size and mitered frames with covers
- Tension Clips
- Frame Braces for LED applications (Part #5357)
- All screws required to assemble by mechanical fastening
- All Corner Angles and/or Corner Keys required
- Packaging

Not Included in Kits:

- Face or Back
- Electrical Components
- Ballast Bracket(s) - See optional accessories
- Back Braces and Gussets
- Frame Support Tube - See optional accessories
- Raceway Covers and Cover Screws - See optional accessories
- Divider(s) - See optional accessories
- 6" and 9" Radius Corners - See optional accessories

Not Included in Kits:

- Tension Tool - See optional accessories
- Mounting Provisions

Optional Accessories (pgs 127-128):

- Ballast Bracket(s)
- Frame Support Tube
- Raceway Covers and Cover Screws
- Divider(s)
- 6" and 9" Radius Corners
- Tension Tool

Kit Specifications:

- It is recommended to order kits 1" over nominal T12 or T8 lamp size to utilize .040 flat Aluminum Raceway Covers
- Custom size kits may be cut to any dimension
- Flexible Face Preparation - See page 129
- Frame Brace / Frame Support Tube placement - See page 130

Recommended Lamp Spacing:

- For illuminated backgrounds - 12" on center, using T12 or T8 lamps
- Always place lamps 3/4" from back of sign
- When using lamps, deduct \$6.01 per Frame Brace

Divider Kits Include:

- Cut to size dividers
- Divider Corner Angles
- All screws required to assemble by mechanical fastening
- Tension Clips
- Dual Divider and 2-1/2" Dual Divider Cover, Parts #2142 and #2146, Mill Finish \$15.33 and Dk. Bronze \$18.54 per/ft per/face

Additional Information (pgs 196-197)

UL Recognized Component Systems
The Underwriters Laboratory file number is E136850

Note: It is recommended to use safety chains and prop-bars on all hingeable faces.

US Patent Numbers 6,061,941 / 6,637,080
CA Patent Numbers 2,245,623 / 2,387,222

Unassembled Double Face Kits w/ Reveal - For Rigid or Flexible Faces

Medium Body w/ Dual Frame and 2-1/4" Dual Frame Cover

Part #2015
KMB/65

Part #2065

Part #2075

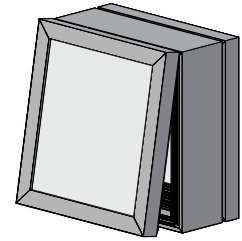
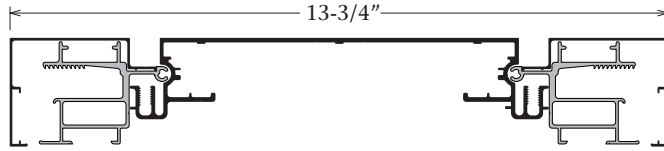

Size H'xW'	Mill Finish	Dk. Bronze	Size H'xW'	Mill Finish	Dk. Bronze	Size H'xW'	Mill Finish	Dk. Bronze	Size H'xW'	Mill Finish	Dk. Bronze
2 x 3	\$718	\$862	4 x 4	\$956	\$1160	6 x 6	\$1342	\$1608	8 x 14	\$2253	\$2691
2 x 4	795	959	4 x 5	1041	1263	6 x 7	1447	1734	8 x 15	2340	2801
2 x 5	878	1065	4 x 6	1152	1386	6 x 8	1525	1831	8 x 16	2420	2893
2 x 6	982	1188	4 x 7	1257	1510	6 x 9	1616	1938	8 x 17	2527	3024
2 x 7	1090	1312	4 x 8	1340	1607	6 x 10	1716	2055	8 x 18	2611	3125
2 x 8	1168	1403	4 x 9	1425	1712	6 x 11	1800	2156	8 x 19	2722	3250
2 x 9	1260	1517	4 x 10	1526	1833	6 x 12	1881	2258	8 x 20	2798	3344
2 x 10	1364	1632	4 x 11	1611	1937	6 x 13	1990	2381			
2 x 11	1447	1734	4 x 12	1695	2035	6 x 14	2072	2477	9 x 9	1883	2261
2 x 12	1529	1834	4 x 13	1804	2164	6 x 15	2158	2586	9 x 10	1988	2376
2 x 13	1640	1962	4 x 14	1879	2256	6 x 16	2263	2703	9 x 11	2073	2479
2 x 14	1718	2057	4 x 15	1973	2368	6 x 17	2341	2804	9 x 12	2155	2580
2 x 15	1806	2167	4 x 16	2075	2481	6 x 18	2426	2908	9 x 13	2265	2706
2 x 16	1907	2283	4 x 17	2156	2582	6 x 19	2536	3031	9 x 14	2338	2800
2 x 17	1990	2381	4 x 18	2242	2682	6 x 20	2616	3129	9 x 15	2428	2911
2 x 18	2077	2483	4 x 19	2350	2808				9 x 16	2532	3028
2 x 19	2182	2610	4 x 20	2425	2907	7 x 7	1550	1858	9 x 17	2618	3130
2 x 20	2263	2703				7 x 8	1629	1951	9 x 18	2702	3229
			5 x 5	1121	1356	7 x 9	1721	2061	9 x 19	2808	3356
3 x 3	801	974	5 x 6	1233	1485	7 x 10	1822	2175	9 x 20	2887	3452
3 x 4	881	1066	5 x 7	1343	1609	7 x 11	1905	2281			
3 x 5	963	1170	5 x 8	1419	1705	7 x 12	1989	2380	10 x 10	2083	2492
3 x 6	1073	1290	5 x 9	1507	1812	7 x 13	2097	2505	10 x 11	2170	2596
3 x 7	1183	1421	5 x 10	1609	1933	7 x 14	2175	2599	10 x 12	2256	2697
3 x 8	1259	1513	5 x 11	1695	2035	7 x 15	2266	2710	10 x 13	2363	2825
3 x 9	1348	1624	5 x 12	1778	2137	7 x 16	2366	2829	10 x 14	2444	2917
3 x 10	1449	1736	5 x 13	1886	2262	7 x 17	2449	2932	10 x 15	2531	3027
3 x 11	1533	1837	5 x 14	1965	2353	7 x 18	2536	3031	10 x 16	2633	3143
3 x 12	1623	1941	5 x 15	2053	2460	7 x 19	2643	3157	10 x 17	2715	3244
3 x 13	1727	2064	5 x 16	2155	2580	7 x 20	2722	3250	10 x 18	2798	3344
3 x 14	1804	2164	5 x 17	2242	2682				10 x 19	2909	3470
3 x 15	1893	2267	5 x 18	2323	2782	8 x 8	1708	2049	10 x 20	2986	3568
3 x 16	1997	2390	5 x 19	2428	2911	8 x 9	1799	2152			
3 x 17	2079	2492	5 x 20	2507	3003	8 x 10	1877	2249			
3 x 18	2162	2592				8 x 11	1984	2372			
3 x 19	2269	2715				8 x 12	2068	2476			
3 x 20	2350	2808				8 x 13	2152	2575			

Kits Include:

- Mill Finish or Dk. Bronze
- Cut to size and mitered bodies
- Cut to size and mitered frames with covers
- Tension Clips
- Frame Braces for LED applications (Part #5357)
- All screws required to assemble by mechanical fastening
- All Corner Angles and/or Corner Keys required
- Packaging

Not Included in Kits:

- Faces
- Electrical Components
- Ballast Bracket(s) - See optional accessories
- Internal Supports
- Frame Support Tube - See optional accessories
- Raceway Covers and Cover Screws - See optional accessories
- Divider(s) - See optional accessories
- 6" and 9" Radius Corners - See optional accessories
- Tension Tool - See optional accessories

Optional Accessories (pgs 127-128):

- Ballast Bracket(s)
- Frame Support Tube
- Raceway Covers and Cover Screws
- Divider(s)
- 6" and 9" Radius Corners
- Tension Tool

Kit Specifications:

- It is recommended to order kits 1" over nominal T12 or T8 lamp size to utilize .040 flat Aluminum Raceway Covers
- Custom size kits may be cut to any dimension
- Flexible Face Preparation - See page 129
- Frame Brace / Frame Support Tube placement - See page 130

Recommended Lamp Spacing:

- For illuminated backgrounds - 10" on center, using T12 or T8 lamps
- When using lamps, deduct \$6.01 per Frame Brace

Divider Kits Include:

- Cut to size dividers
- Divider Corner Angles
- All screws required to assemble by mechanical fastening
- Tension Clips
- Dual Divider and 2-1/2" Dual Divider Cover, Parts #2142 and #2146, Mill Finish \$15.33 and Dk. Bronze \$18.54 per/ft per/face

Additional Information (pgs 196-197)



Note: All dimensions are subject to the tolerance standards of the aluminum extrusion industry. Profile drawings are illustrative and rounded to the nearest 1/16".

CURRENT PRICE as of April 1, 2022



COMMERCIAL

Unassembled Double Face Kits w/ Reveal - For Rigid or Flexible Faces

Wide Body w/ Dual Frame and 2-1/4" Dual Frame Cover

Part #2005
KWB/65

Part #2065

Part #2075

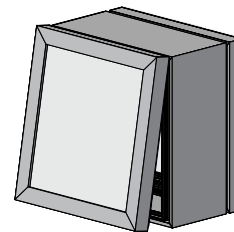
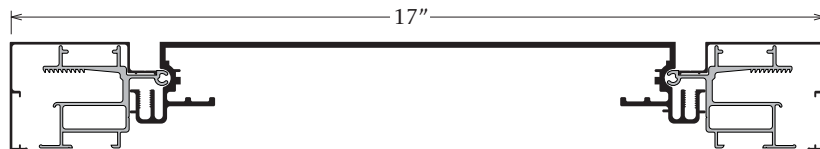

Size H'xW'	Mill Finish	Dk. Bronze	Size H'xW'	Mill Finish	Dk. Bronze	Size H'xW'	Mill Finish	Dk. Bronze	Size H'xW'	Mill Finish	Dk. Bronze
2 x 3	\$801	\$974	4 x 4	\$1088	\$1315	6 x 6	\$1520	\$1833	8 x 14	\$2577	\$3086
2 x 4	895	1082	4 x 5	1184	1434	6 x 7	1647	1970	8 x 15	2679	3208
2 x 5	991	1201	4 x 6	1309	1576	6 x 8	1736	2084	8 x 16	2768	3319
2 x 6	1113	1343	4 x 7	1430	1719	6 x 9	1838	2211	8 x 17	2895	3464
2 x 7	1235	1486	4 x 8	1520	1833	6 x 10	1958	2347	8 x 18	2989	3581
2 x 8	1327	1600	4 x 9	1625	1954	6 x 11	2053	2460	8 x 19	3109	3724
2 x 9	1431	1723	4 x 10	1740	2091	6 x 12	2151	2580	8 x 20	3201	3835
2 x 10	1546	1858	4 x 11	1837	2206	6 x 13	2274	2725	9 x 9	2152	2582
2 x 11	1647	1970	4 x 12	1935	2323	6 x 14	2366	2833	9 x 10	2269	2718
2 x 12	1743	2092	4 x 13	2058	2470	6 x 15	2467	2959	9 x 11	2368	2838
2 x 13	1863	2235	4 x 14	2149	2579	6 x 16	2583	3093	9 x 12	2463	2952
2 x 14	1958	2347	4 x 15	2253	2703	6 x 17	2681	3209	9 x 13	2584	3094
2 x 15	2060	2472	4 x 16	2369	2840	6 x 18	2777	3328	9 x 14	2678	3206
2 x 16	2174	2603	4 x 17	2465	2956	6 x 19	2900	3474	9 x 15	2780	3331
2 x 17	2274	2725	4 x 18	2563	3077	6 x 20	2992	3586	9 x 16	2896	3466
2 x 18	2370	2841	4 x 19	2682	3216	7 x 7	1764	2115	9 x 17	2995	3597
2 x 19	2491	2982	4 x 20	2777	3328	7 x 8	1858	2223	9 x 18	3091	3705
2 x 20	2583	3093				7 x 9	1962	2350	9 x 19	3213	3846
			5 x 5	1279	1550	7 x 10	2077	2483	9 x 20	3304	3955
3 x 3	904	1097	5 x 6	1403	1692	7 x 11	2172	2602	10 x 10	2385	2852
3 x 4	1002	1207	5 x 7	1526	1837	7 x 12	2273	2719	10 x 11	2479	2968
3 x 5	1094	1323	5 x 8	1618	1945	7 x 13	2393	2863	10 x 12	2579	3087
3 x 6	1216	1465	5 x 9	1721	2072	7 x 14	2481	2975	10 x 13	2579	3087
3 x 7	1342	1608	5 x 10	1835	2204	7 x 15	2586	3101	10 x 14	2789	3339
3 x 8	1430	1719	5 x 11	1935	2323	7 x 16	2705	3232	10 x 15	2896	3466
3 x 9	1530	1843	5 x 12	2033	2445	7 x 17	2801	3352	10 x 16	3011	3603
3 x 10	1649	1977	5 x 13	2152	2582	7 x 18	2900	3474	10 x 17	3107	3720
3 x 11	1746	2096	5 x 14	2246	2694	7 x 19	3020	3612	10 x 18	3205	3836
3 x 12	1844	2216	5 x 15	2347	2817	7 x 20	3109	3724	10 x 19	3328	3978
3 x 13	1966	2356	5 x 16	2465	2956	8 x 8	1946	2335	10 x 20	3419	4092
3 x 14	2058	2470	5 x 17	2561	3071	8 x 9	2053	2460			
3 x 15	2162	2595	5 x 18	2659	3193	8 x 10	2144	2574			
3 x 16	2278	2731	5 x 19	2782	3335	8 x 11	2265	2710			
3 x 17	2372	2845	5 x 20	2873	3448	8 x 12	2365	2832			
3 x 18	2472	2963				8 x 13	2458	2951			
3 x 19	2595	3107									
3 x 20	2684	3217									

Kits Include:

- Mill Finish or Dk. Bronze
- Cut to size and mitered bodies
- Cut to size and mitered frames with covers
- Tension Clips
- Frame Braces for LED applications (Part #5357)
- All screws required to assemble by mechanical fastening
- All Corner Angles and/or Corner Keys required
- Packaging

Not Included in Kits:

- Faces
- Electrical Components
- Ballast Bracket(s) - See optional accessories
- Internal Supports
- Frame Support Tube - See optional accessories
- Raceway Covers and Cover Screws- See optional accessories
- Divider(s) - See optional accessories
- 6" and 9" Radius Corners - See optional accessories
- Tension Tool - See optional accessories

Optional Accessories (pgs 127-128):

- Ballast Bracket(s)
- Frame Support Tube
- Raceway Covers and Cover Screws
- Divider(s)
- 6" and 9" Radius Corners
- Tension Tool

Kit Specifications:

- It is recommended to order kits 1" over nominal T12 or T8 lamp size to utilize .040 flat Aluminum Raceway Covers.
- Custom size kits may be cut to any dimension
- Flexible Face Preparation - See page 129
- Frame Brace / Frame Support Tube placement - See page 130

Recommended Lamp Spacing:

- For illuminated backgrounds - 12" on center, using T12 or T8 lamps
- When using lamps, deduct \$6.01 per Frame Brace

Divider Kits Include:

- Cut to size dividers
- Divider Corner Angles
- All screws required to assemble by mechanical fastening
- Tension Clips
- Dual Divider and 2-1/2" Dual Divider Cover, Parts #2142 and #2146, Mill Finish \$15.33 and Dk. Bronze \$18.54 per/ft per/face

Additional Information (pgs 196-197)

UL Recognized Component Systems
The Underwriters Laboratory file number is E136850

Note: It is recommended to use safety chains and prop-bars on all hingeable faces.

US Patent Numbers 6,061,941 / 6,637,080
CA Patent Numbers 2,245,623 / 2,387,222

Unassembled Retro Kits w/ Reveal - For Pan Form Faces

Retro Body w/ Bleed Rigid Retainer

Part #2040
K2040/48

Part #2048

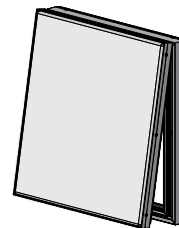
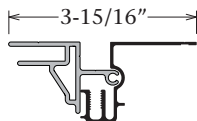

Size H'xW'	Mill Finish	Size H'xW'	Mill Finish	Size H'xW'	Mill Finish	Size H'xW'	Mill Finish
2 x 3	\$159	4 x 4	\$221	6 x 6	\$301	8 x 14	\$499
2 x 4	181	4 x 5	241	6 x 7	320	8 x 15	519
2 x 5	201	4 x 6	261	6 x 8	340	8 x 16	538
2 x 6	221	4 x 7	280	6 x 9	360	8 x 17	560
2 x 7	241	4 x 8	301	6 x 10	380	8 x 18	578
2 x 8	261	4 x 9	320	6 x 11	399	8 x 19	598
2 x 9	280	4 x 10	340	6 x 12	419	8 x 20	618
2 x 10	301	4 x 11	360	6 x 13	440		
2 x 11	320	4 x 12	380	6 x 14	459	9 x 9	419
2 x 12	340	4 x 13	399	6 x 15	478	9 x 10	440
2 x 13	361	4 x 14	419	6 x 16	499	9 x 11	459
2 x 14	380	4 x 15	440	6 x 17	519	9 x 12	478
2 x 15	399	4 x 16	459	6 x 18	539	9 x 13	499
2 x 16	419	4 x 17	478	6 x 19	560	9 x 14	519
2 x 17	440	4 x 18	499	6 x 20	578	9 x 15	538
2 x 18	460	4 x 19	519			9 x 16	560
2 x 19	478	4 x 20	539	7 x 7	340	9 x 17	578
2 x 20	499			7 x 8	360	9 x 18	598
		5 x 5	261	7 x 9	380	9 x 19	618
3 x 3	181	5 x 6	280	7 x 10	399	9 x 20	638
3 x 4	201	5 x 7	301	7 x 11	419		
3 x 5	221	5 x 8	320	7 x 12	440	10 x 10	459
3 x 6	241	5 x 9	340	7 x 13	459	10 x 11	478
3 x 7	261	5 x 10	360	7 x 14	478	10 x 12	499
3 x 8	280	5 x 11	380	7 x 15	499	10 x 13	519
3 x 9	301	5 x 12	399	7 x 16	519	10 x 14	538
3 x 10	320	5 x 13	419	7 x 17	539	10 x 15	560
3 x 11	340	5 x 14	440	7 x 18	560	10 x 16	578
3 x 12	361	5 x 15	459	7 x 19	578	10 x 17	598
3 x 13	380	5 x 16	478	7 x 20	598	10 x 18	618
3 x 14	399	5 x 17	499			10 x 19	638
3 x 15	419	5 x 18	519	8 x 8	380	10 x 20	655
3 x 16	440	5 x 19	539	8 x 9	399		
3 x 17	460	5 x 20	560	8 x 10	419		
3 x 18	478			8 x 11	440		
3 x 19	499			8 x 12	459		
3 x 20	519			8 x 13	478		

Kits Include:

- Mill Finish
- Cut to size and mitered bodies
- Cut to size and mitered retainers
- All screws required to assemble by mechanical fastening
- All Corner Angles and/or Corner Keys required
- Face attachment hardware
- Packaging
- Prices reflect one (1) Retro Body kit, SINGLE FACE APPLICATION

Kit Specifications:

- Kits will be cut .265" larger to fit over existing structure
- Custom size kits may be cut to any dimension
- Illumination may vary depending on application

Additional Information (pgs 196-197)

Not Included in Kits:

- Face
- Electrical Components
- Mounting Provisions

Note: All dimensions are subject to the tolerance standards of the aluminum extrusion industry. Profile drawings are illustrative and rounded to the nearest 1/16".

**CURRENT PRICE as
of April 1, 2022**



COMMERCIAL

Unassembled Single Face Kits w/ Reveal - For Pan Form Faces

Slimline Single Face Body w/ Bleed Rigid Retainer

Part #2020
K2020/48

Part #2048

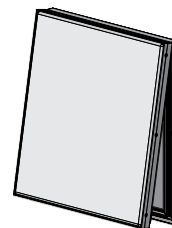
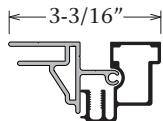

Size H'xW'	Mill Finish	Size H'xW'	Mill Finish	Size H'xW'	Mill Finish	Size H'xW'	Mill Finish
2 x 3	\$187	4 x 4	\$255	6 x 6	\$345	8 x 14	\$567
2 x 4	211	4 x 5	278	6 x 7	367	8 x 15	591
2 x 5	233	4 x 6	301	6 x 8	388	8 x 16	613
2 x 6	255	4 x 7	321	6 x 9	412	8 x 17	637
2 x 7	278	4 x 8	345	6 x 10	434	8 x 18	655
2 x 8	301	4 x 9	367	6 x 11	456	8 x 19	678
2 x 9	321	4 x 10	388	6 x 12	478	8 x 20	701
2 x 10	345	4 x 11	412	6 x 13	500		
2 x 11	367	4 x 12	434	6 x 14	522	9 x 9	478
2 x 12	389	4 x 13	456	6 x 15	546	9 x 10	500
2 x 13	412	4 x 14	478	6 x 16	567	9 x 11	522
2 x 14	434	4 x 15	500	6 x 17	591	9 x 12	546
2 x 15	457	4 x 16	523	6 x 18	613	9 x 13	567
2 x 16	478	4 x 17	546	6 x 19	637	9 x 14	591
2 x 17	500	4 x 18	567	6 x 20	655	9 x 15	613
2 x 18	523	4 x 19	591			9 x 16	637
2 x 19	546	4 x 20	613	7 x 7	388	9 x 17	655
2 x 20	567			7 x 8	412	9 x 18	678
		5 x 5	301	7 x 9	434	9 x 19	701
3 x 3	211	5 x 6	321	7 x 10	456	9 x 20	724
3 x 4	233	5 x 7	345	7 x 11	478		
3 x 5	255	5 x 8	367	7 x 12	500	10 x 10	522
3 x 6	278	5 x 9	388	7 x 13	522	10 x 11	546
3 x 7	301	5 x 10	412	7 x 14	546	10 x 12	567
3 x 8	321	5 x 11	434	7 x 15	567	10 x 13	591
3 x 9	345	5 x 12	456	7 x 16	591	10 x 14	613
3 x 10	367	5 x 13	478	7 x 17	613	10 x 15	637
3 x 11	388	5 x 14	500	7 x 18	637	10 x 16	655
3 x 12	412	5 x 15	523	7 x 19	655	10 x 17	678
3 x 13	434	5 x 16	546	7 x 20	678	10 x 18	701
3 x 14	457	5 x 17	567			10 x 19	724
3 x 15	478	5 x 18	591	8 x 8	434	10 x 20	745
3 x 16	500	5 x 19	613	8 x 9	456		
3 x 17	523	5 x 20	637	8 x 10	478		
3 x 18	546			8 x 11	500		
3 x 19	567			8 x 12	522		
3 x 20	591			8 x 13	546		

Kits Include:

- Mill Finish
- Cut to size and mitered bodies
- Cut to size and mitered retainers
- All screws required to assemble by mechanical fastening
- All Corner Angles and/or Corner Keys required
- Face attachment hardware
- Packaging

Not Included in Kits:

- Face or Back
- Electrical Components
- Back Braces and Gussets
- Mounting Provisions

Kit Specifications:

- Recommended for LED applications
- Custom size kits may be cut to any dimension

Additional Information (pgs 196-197)

Note: It is recommended to use safety chains and prop-bars on all hingeable faces.

Unassembled Single Face Kits w/ Reveal - For Pan Form Faces

Narrow Single Face Body w/ Bleed Rigid Retainer

Part #2021
K2021/48

Part #2048

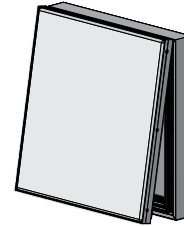
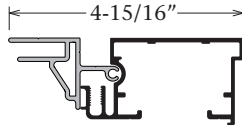

Size H'xW'	Mill Finish	Size H'xW'	Mill Finish	Size H'xW'	Mill Finish	Size H'xW'	Mill Finish
2 x 3	\$239	4 x 4	\$322	6 x 6	\$435	8 x 14	\$717
2 x 4	266	4 x 5	352	6 x 7	463	8 x 15	745
2 x 5	294	4 x 6	380	6 x 8	491	8 x 16	773
2 x 6	322	4 x 7	408	6 x 9	519	8 x 17	801
2 x 7	352	4 x 8	435	6 x 10	547	8 x 18	828
2 x 8	380	4 x 9	463	6 x 11	576	8 x 19	856
2 x 9	408	4 x 10	492	6 x 12	603	8 x 20	884
2 x 10	435	4 x 11	519	6 x 13	631		
2 x 11	463	4 x 12	547	6 x 14	661	9 x 9	603
2 x 12	492	4 x 13	576	6 x 15	689	9 x 10	631
2 x 13	519	4 x 14	603	6 x 16	717	9 x 11	661
2 x 14	548	4 x 15	631	6 x 17	745	9 x 12	689
2 x 15	576	4 x 16	661	6 x 18	773	9 x 13	717
2 x 16	603	4 x 17	689	6 x 19	801	9 x 14	745
2 x 17	631	4 x 18	717	6 x 20	828	9 x 15	773
2 x 18	661	4 x 19	745			9 x 16	801
2 x 19	689	4 x 20	773	7 x 7	491	9 x 17	828
2 x 20	717			7 x 8	519	9 x 18	856
		5 x 5	380	7 x 9	547	9 x 19	884
3 x 3	266	5 x 6	408	7 x 10	576	9 x 20	914
3 x 4	294	5 x 7	435	7 x 11	603		
3 x 5	322	5 x 8	463	7 x 12	631	10 x 10	661
3 x 6	352	5 x 9	492	7 x 13	661	10 x 11	689
3 x 7	380	5 x 10	519	7 x 14	689	10 x 12	717
3 x 8	408	5 x 11	547	7 x 15	717	10 x 13	745
3 x 9	435	5 x 12	576	7 x 16	745	10 x 14	773
3 x 10	463	5 x 13	603	7 x 17	773	10 x 15	801
3 x 11	492	5 x 14	631	7 x 18	801	10 x 16	828
3 x 12	519	5 x 15	661	7 x 19	828	10 x 17	856
3 x 13	548	5 x 16	689	7 x 20	856	10 x 18	884
3 x 14	576	5 x 17	717			10 x 19	914
3 x 15	603	5 x 18	745	8 x 8	547	10 x 20	938
3 x 16	631	5 x 19	773	8 x 9	576		
3 x 17	661	5 x 20	801	8 x 10	603		
3 x 18	689			8 x 11	631		
3 x 19	717			8 x 12	661		
3 x 20	745			8 x 13	689		

Kits Include:

- Mill Finish.
- Cut to size and mitered bodies
- Cut to size and mitered retainers
- All screws required to assemble by mechanical fastening
- All Corner Angles and/or Corner Keys required
- Face attachment hardware
- Packaging

Not Included in Kits:

- Face or Back
- Electrical Components
- Back Braces and Gussets
- Mounting Provisions

Kit Specifications:

- Recommended for LED applications
- Custom size kits may be cut to any dimension

Additional Information (pgs 196-197)

Note: All dimensions are subject to the tolerance standards of the aluminum extrusion industry. Profile drawings are illustrative and rounded to the nearest 1/16".

CURRENT PRICE as of April 1, 2022



COMMERCIAL

Unassembled Single Face Kits w/ Reveal - For Pan Form Faces

Single Face Body w/ Bleed Rigid Retainer

Part #2025
KSF/48

Part #2048

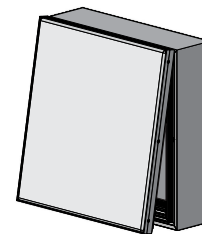
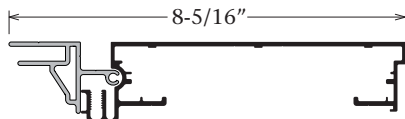

Size H'xW'	Mill Finish	Size H'xW'	Mill Finish	Size H'xW'	Mill Finish	Size H'xW'	Mill Finish
2 x 3	\$294	4 x 4	\$396	6 x 6	\$532	8 x 14	\$872
2 x 4	330	4 x 5	431	6 x 7	566	8 x 15	906
2 x 5	364	4 x 6	464	6 x 8	599	8 x 16	939
2 x 6	396	4 x 7	499	6 x 9	633	8 x 17	975
2 x 7	431	4 x 8	532	6 x 10	669	8 x 18	1007
2 x 8	464	4 x 9	566	6 x 11	702	8 x 19	1041
2 x 9	499	4 x 10	599	6 x 12	734	8 x 20	1076
2 x 10	534	4 x 11	633	6 x 13	771	9 x 9	734
2 x 11	566	4 x 12	669	6 x 14	804	9 x 10	771
2 x 12	599	4 x 13	702	6 x 15	837	9 x 11	804
2 x 13	633	4 x 14	734	6 x 16	872	9 x 12	837
2 x 14	669	4 x 15	771	6 x 17	906	9 x 13	872
2 x 15	702	4 x 16	804	6 x 18	939	9 x 14	906
2 x 16	734	4 x 17	837	6 x 19	975	9 x 15	939
2 x 17	771	4 x 18	872	6 x 20	1007	9 x 16	975
2 x 18	804	4 x 19	906	7 x 7	599	9 x 17	1007
2 x 19	837	4 x 20	939	7 x 8	633	9 x 18	1041
2 x 20	872	5 x 5	464	7 x 9	669	9 x 19	1076
3 x 3	330	5 x 6	499	7 x 10	702	9 x 20	1110
3 x 4	364	5 x 7	532	7 x 11	734	10 x 10	804
3 x 5	396	5 x 8	566	7 x 12	771	10 x 11	837
3 x 6	431	5 x 9	599	7 x 13	804	10 x 12	872
3 x 7	464	5 x 10	633	7 x 14	837	10 x 13	906
3 x 8	499	5 x 11	669	7 x 15	872	10 x 14	939
3 x 9	532	5 x 12	702	7 x 16	906	10 x 15	975
3 x 10	566	5 x 13	734	7 x 17	939	10 x 16	1007
3 x 11	599	5 x 14	771	7 x 18	975	10 x 17	1041
3 x 12	633	5 x 15	804	7 x 19	1007	10 x 18	1076
3 x 13	669	5 x 16	837	7 x 20	1041	10 x 19	1110
3 x 14	702	5 x 17	872	8 x 8	669	10 x 20	1141
3 x 15	734	5 x 18	906	8 x 9	702		
3 x 16	771	5 x 19	939	8 x 10	734		
3 x 17	804	5 x 20	975	8 x 11	771		
3 x 18	837			8 x 12	804		
3 x 19	872			8 x 13	837		
3 x 20	906						

Kits Include:

- Mill Finish
- Cut to size and mitered bodies
- Cut to size and mitered retainers
- All screws required to assemble by mechanical fastening
- All Corner Angles and/or Corner Keys required
- Face attachment hardware
- Packaging

Not Included in Kits:

- Face or Back
- Electrical Components
- Ballast Bracket(s) - See optional accessories
- Back Braces and Gussets
- Raceway Covers and Cover Screws - See optional accessories
- Mounting Provisions

Optional Accessories (pg 127):

- Ballast Bracket(s)
- Raceway Covers and Cover Screws

Kit Specifications:

- It is recommended to order kits 1" over nominal T12 or T8 lamp size to utilize .040 flat Aluminum Raceway Covers
- Custom size kits may be cut to any dimension

Recommended Lamp Spacing:

- For illuminated backgrounds - 10" on center, using T12 or T8 lamps
- Always place lamps 3/4" from back of sign

Additional Information (pgs 196-197)

Note: It is recommended to use safety chains and prop-bars on all hingeable faces.

Unassembled Double Face Kits w/ Reveal - For Pan Form Faces

Medium Body w/ Bleed Rigid Retainer

Part #2015
KMB/48

Part #2048

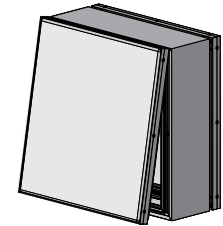
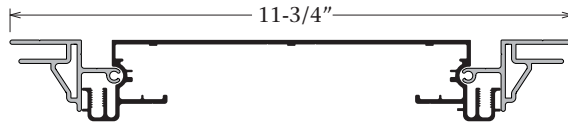

Size H'xW'	Mill Finish	Size H'xW'	Mill Finish	Size H'xW'	Mill Finish	Size H'xW'	Mill Finish
2 x 3	\$460	4 x 4	\$618	6 x 6	\$832	8 x 14	\$1371
2 x 4	514	4 x 5	673	6 x 7	887	8 x 15	1423
2 x 5	566	4 x 6	728	6 x 8	942	8 x 16	1477
2 x 6	618	4 x 7	780	6 x 9	994	8 x 17	1532
2 x 7	673	4 x 8	832	6 x 10	1046	8 x 18	1584
2 x 8	728	4 x 9	887	6 x 11	1102	8 x 19	1637
2 x 9	780	4 x 10	942	6 x 12	1156	8 x 20	1692
2 x 10	832	4 x 11	994	6 x 13	1209		
2 x 11	887	4 x 12	1046	6 x 14	1263	9 x 9	1156
2 x 12	942	4 x 13	1102	6 x 15	1316	9 x 10	1209
2 x 13	994	4 x 14	1156	6 x 16	1371	9 x 11	1263
2 x 14	1046	4 x 15	1209	6 x 17	1423	9 x 12	1316
2 x 15	1102	4 x 16	1263	6 x 18	1477	9 x 13	1371
2 x 16	1156	4 x 17	1316	6 x 19	1532	9 x 14	1423
2 x 17	1209	4 x 18	1371	6 x 20	1584	9 x 15	1477
2 x 18	1264	4 x 19	1425			9 x 16	1532
2 x 19	1316	4 x 20	1478	7 x 7	939	9 x 17	1584
2 x 20	1371			7 x 8	994	9 x 18	1637
		5 x 5	728	7 x 9	1046	9 x 19	1692
3 x 3	514	5 x 6	780	7 x 10	1102	9 x 20	1744
3 x 4	566	5 x 7	832	7 x 11	1156		
3 x 5	618	5 x 8	887	7 x 12	1209	10 x 10	1263
3 x 6	673	5 x 9	942	7 x 13	1263	10 x 11	1316
3 x 7	728	5 x 10	994	7 x 14	1316	10 x 12	1371
3 x 8	780	5 x 11	1046	7 x 15	1371	10 x 13	1423
3 x 9	832	5 x 12	1102	7 x 16	1423	10 x 14	1477
3 x 10	887	5 x 13	1156	7 x 17	1477	10 x 15	1532
3 x 11	942	5 x 14	1209	7 x 18	1532	10 x 16	1584
3 x 12	994	5 x 15	1263	7 x 19	1584	10 x 17	1637
3 x 13	1046	5 x 16	1316	7 x 20	1637	10 x 18	1692
3 x 14	1102	5 x 17	1371			10 x 19	1744
3 x 15	1156	5 x 18	1425	8 x 8	1046	10 x 20	1794
3 x 16	1209	5 x 19	1478	8 x 9	1102		
3 x 17	1264	5 x 20	1532	8 x 10	1156		
3 x 18	1316			8 x 11	1209		
3 x 19	1371			8 x 12	1263		
3 x 20	1425			8 x 13	1316		

Kits Include:

- Mill Finish
- Cut to size and mitered bodies
- Cut to size and mitered retainers
- All screws required to assemble by mechanical fastening
- All Corner Angles and/or Corner Keys required
- Face attachment hardware
- Packaging

Not Included in Kits:

- Faces
- Electrical Components
- Ballast Bracket(s) - See optional accessories
- Internal Supports
- Raceway Covers and Cover Screws - See optional accessories

Optional Accessories (pg 127):

- Ballast Bracket(s)
- Raceway Covers and Cover Screws

Kit Specifications:

- It is recommended to order kits 1" over nominal T12 or T8 lamp size to utilize .040 flat Aluminum Raceway Covers
- Custom size kits may be cut to any dimension

Recommended Lamp Spacing:

- For illuminated backgrounds - 10" on center, using T12 or T8 lamps

Additional Information (pgs 196-197)

Note: All dimensions are subject to the tolerance standards of the aluminum extrusion industry. Profile drawings are illustrative and rounded to the nearest 1/16".

CURRENT PRICE as of April 1, 2022



COMMERCIAL

Unassembled Double Face Kits w/ Reveal - For Pan Form Faces

Wide Body w/ Bleed Rigid Retainer

Part #2005
KWB/48

Part #2048

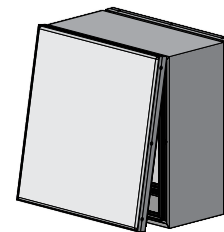
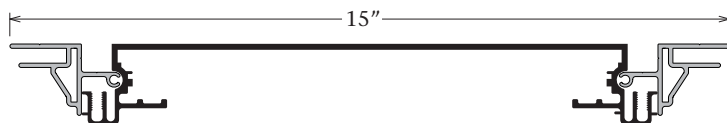

Size H'xW'	Mill Finish	Size H'xW'	Mill Finish	Size H'xW'	Mill Finish	Size H'xW'	Mill Finish
2 x 3	\$579	4 x 4	\$783	6 x 6	\$1055	8 x 14	\$1737
2 x 4	646	4 x 5	852	6 x 7	1122	8 x 15	1806
2 x 5	716	4 x 6	920	6 x 8	1192	8 x 16	1874
2 x 6	783	4 x 7	988	6 x 9	1260	8 x 17	1942
2 x 7	852	4 x 8	1055	6 x 10	1328	8 x 18	2009
2 x 8	920	4 x 9	1122	6 x 11	1397	8 x 19	2077
2 x 9	988	4 x 10	1192	6 x 12	1465	8 x 20	2146
2 x 10	1055	4 x 11	1260	6 x 13	1533		
2 x 11	1125	4 x 12	1328	6 x 14	1601	9 x 9	1465
2 x 12	1192	4 x 13	1397	6 x 15	1668	9 x 10	1533
2 x 13	1260	4 x 14	1465	6 x 16	1739	9 x 11	1601
2 x 14	1328	4 x 15	1533	6 x 17	1806	9 x 12	1668
2 x 15	1397	4 x 16	1601	6 x 18	1874	9 x 13	1737
2 x 16	1465	4 x 17	1668	6 x 19	1944	9 x 14	1806
2 x 17	1533	4 x 18	1739	6 x 20	2009	9 x 15	1874
2 x 18	1601	4 x 19	1806			9 x 16	1942
2 x 19	1668	4 x 20	1874	7 x 7	1192	9 x 17	2009
2 x 20	1739			7 x 8	1259	9 x 18	2077
		5 x 5	920	7 x 9	1328	9 x 19	2146
3 x 3	646	5 x 6	988	7 x 10	1397	9 x 20	2215
3 x 4	716	5 x 7	1055	7 x 11	1465		
3 x 5	783	5 x 8	1122	7 x 12	1533	10 x 10	1601
3 x 6	852	5 x 9	1192	7 x 13	1601	10 x 11	1668
3 x 7	920	5 x 10	1260	7 x 14	1668	10 x 12	1737
3 x 8	988	5 x 11	1328	7 x 15	1737	10 x 13	1806
3 x 9	1055	5 x 12	1397	7 x 16	1806	10 x 14	1874
3 x 10	1122	5 x 13	1465	7 x 17	1874	10 x 15	1942
3 x 11	1192	5 x 14	1533	7 x 18	1944	10 x 16	2009
3 x 12	1260	5 x 15	1601	7 x 19	2009	10 x 17	2077
3 x 13	1328	5 x 16	1668	7 x 20	2077	10 x 18	2146
3 x 14	1397	5 x 17	1739			10 x 19	2215
3 x 15	1465	5 x 18	1806	8 x 8	1327	10 x 20	2278
3 x 16	1533	5 x 19	1874	8 x 9	1397		
3 x 17	1601	5 x 20	1944	8 x 10	1465		
3 x 18	1668			8 x 11	1533		
3 x 19	1739			8 x 12	1601		
3 x 20	1807			8 x 13	1668		

Kits Include:

- Mill Finish
- Cut to size and mitered bodies
- Cut to size and mitered retainers
- All screws required to assemble by mechanical fastening
- All Corner Angles and/or Corner Keys required
- Face attachment hardware
- Packaging

Not Included in Kits:

- Faces
- Electrical Components
- Ballast Bracket(s) - See optional accessories
- Internal Supports
- Raceway Covers and Cover Screws - See optional accessories

Optional Accessories (pg 127):

- Ballast Bracket(s)
- Raceway Covers and Cover Screws

Kit Specifications:

- It is recommended to order kits 1" over nominal T12 or T8 lamp size to utilize .040 flat Aluminum Raceway Covers
- Custom size kits may be cut to any dimension

Recommended Lamp Spacing:

- For illuminated backgrounds - 10" on center, using T12 or T8 lamps

Additional Information (pgs 196-197)

Note: It is recommended to use safety chains and prop-bars on all hingeable faces.

Note: All dimensions are subject to the tolerance standards of the aluminum extrusion industry. Profile drawings are illustrative and rounded to the nearest 1/16".

CURRENT PRICE as of April 1, 2022



COMMERCIAL

Unassembled Single Face Kits w/ Reveal - For Insert Panels

Slimline Single Face Body w/ Commercial Access Frame and Cover Options

Part #2020

Part #2060

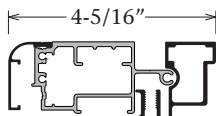

Slide
Part #1694
K2020/60/94



Radius Slide
Part #1695
K2020/60/95



Bleed
Part #1692
K2020/60/92



Frameless
Part #1693
K2020/60/93



* Insert Top/Bottom
Part #1292
K2020/60/92/98

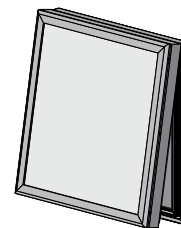

Size H'xW'	Mill Finish	Size H'xW'	Mill Finish	Size H'xW'	Mill Finish	Size H'xW'	Mill Finish
2 x 3	\$255	4 x 4	\$338	6 x 6	\$455	8 x 14	\$740
2 x 4	282	4 x 5	368	6 x 7	483	8 x 15	768
2 x 5	310	4 x 6	396	6 x 8	510	8 x 16	796
2 x 6	338	4 x 7	424	6 x 9	539	8 x 17	825
2 x 7	368	4 x 8	455	6 x 10	567	8 x 18	853
2 x 8	396	4 x 9	483	6 x 11	597	8 x 19	883
2 x 9	424	4 x 10	510	6 x 12	625	8 x 20	911
2 x 10	455	4 x 11	539	6 x 13	653	9 x 9	625
2 x 11	483	4 x 12	567	6 x 14	682	9 x 10	653
2 x 12	510	4 x 13	597	6 x 15	709	9 x 11	682
2 x 13	539	4 x 14	625	6 x 16	740	9 x 12	709
2 x 14	567	4 x 15	654	6 x 17	768	9 x 13	740
2 x 15	597	4 x 16	682	6 x 18	796	9 x 14	768
2 x 16	625	4 x 17	709	6 x 19	825	9 x 15	796
2 x 17	654	4 x 18	740	6 x 20	853	9 x 16	825
2 x 18	682	4 x 19	768	7 x 7	510	9 x 17	853
2 x 19	709	4 x 20	796	7 x 8	539	9 x 18	883
2 x 20	740	5 x 5	396	7 x 9	567	9 x 19	911
3 x 3	282	5 x 6	424	7 x 10	595	9 x 20	939
3 x 4	310	5 x 7	455	7 x 11	625	10 x 10	682
3 x 5	338	5 x 8	483	7 x 12	653	10 x 11	709
3 x 6	368	5 x 9	510	7 x 13	682	10 x 12	740
3 x 7	396	5 x 10	539	7 x 14	709	10 x 13	768
3 x 8	424	5 x 11	567	7 x 15	740	10 x 14	796
3 x 9	455	5 x 12	597	7 x 16	768	10 x 15	825
3 x 10	483	5 x 13	625	7 x 17	796	10 x 16	853
3 x 11	510	5 x 14	653	7 x 18	825	10 x 17	883
3 x 12	539	5 x 15	682	7 x 19	853	10 x 18	911
3 x 13	567	5 x 16	709	7 x 20	883	10 x 19	939
3 x 14	597	5 x 17	740	8 x 8	567	10 x 20	966
3 x 15	625	5 x 18	768	8 x 9	595		
3 x 16	654	5 x 19	796	8 x 10	625		
3 x 17	682	5 x 20	825	8 x 11	653		
3 x 18	709			8 x 12	682		
3 x 19	740			8 x 13	709		
3 x 20	768						

Kits Include:

- Mill Finish (Portions of the Insert Panel System are anodized for sliding purposes only)
- Cut to size and mitered bodies
- Cut to size and mitered frames with covers
- Cut to size insert panels, adaptors and divider (Insert Panel System kits only)
- All screws required to assemble by mechanical fastening
- All Corner Angles and/or Corner Keys required
- Packaging

Not Included in kits:

- Face or Back
- Electrical Components
- Divider(s) - See optional accessories
- Back Braces and Gussets
- Mounting Provisions

Optional Accessories (pg 127):

- Divider(s)

Kit Specifications:

- Recommended for LED applications
- Custom size kits may be cut to any dimension
- Commercial Access Frame integrates with all Architectural Covers and Insert Panel System

Divider Kits Include:

- Cut to size dividers
- Divider Tabs
- All screws required to assemble by mechanical fastening
- 1-1/4" Divider, Part #1662, \$5.81 per/ft per/face
- For use with Slide and Radius Slide Covers

Additional Information (pgs 196-197)

Note: It is recommended to use safety chains and prop-bars on all hingeable faces.

*Call SignComp Customer Service for Insert Panel pricing

Unassembled Single Face Kits w/ Reveal - For Insert Panels

Narrow Single Face Body w/ Commercial Access Frame and Cover Options

Part #2021

Part #2060

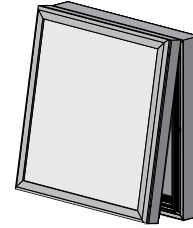
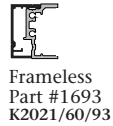
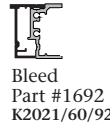
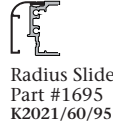
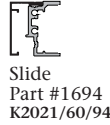
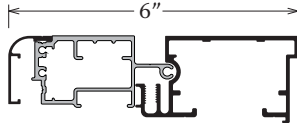

Size H'xW'	Mill Finish	Size H'xW'	Mill Finish	Size H'xW'	Mill Finish	Size H'xW'	Mill Finish
2 x 3	\$304	4 x 4	\$406	6 x 6	\$542	8 x 14	\$885
2 x 4	337	4 x 5	440	6 x 7	576	8 x 15	922
2 x 5	371	4 x 6	474	6 x 8	611	8 x 16	954
2 x 6	406	4 x 7	508	6 x 9	645	8 x 17	990
2 x 7	440	4 x 8	542	6 x 10	678	8 x 18	1025
2 x 8	474	4 x 9	576	6 x 11	714	8 x 19	1058
2 x 9	508	4 x 10	611	6 x 12	748	8 x 20	1092
2 x 10	542	4 x 11	645	6 x 13	783		
2 x 11	576	4 x 12	678	6 x 14	817	9 x 9	748
2 x 12	611	4 x 13	716	6 x 15	852	9 x 10	783
2 x 13	645	4 x 14	748	6 x 16	885	9 x 11	817
2 x 14	678	4 x 15	783	6 x 17	922	9 x 12	852
2 x 15	716	4 x 16	817	6 x 18	954	9 x 13	885
2 x 16	748	4 x 17	852	6 x 19	990	9 x 14	922
2 x 17	783	4 x 18	885	6 x 20	1025	9 x 15	954
2 x 18	817	4 x 19	922			9 x 16	990
2 x 19	852	4 x 20	954	7 x 7	611	9 x 17	1025
2 x 20	887			7 x 8	645	9 x 18	1058
		5 x 5	474	7 x 9	678	9 x 19	1092
		5 x 6	508	7 x 10	714	9 x 20	1129
		5 x 7	542	7 x 11	748		
3 x 3	337	5 x 8	576	7 x 12	783	10 x 10	817
3 x 4	371	5 x 9	611	7 x 13	817	10 x 11	852
3 x 5	406	5 x 10	645	7 x 14	852	10 x 12	885
3 x 6	440	5 x 11	678	7 x 15	885	10 x 13	922
3 x 7	474	5 x 12	714	7 x 16	922	10 x 14	954
3 x 8	508	5 x 13	748	7 x 17	954	10 x 15	990
3 x 9	542	5 x 14	783	7 x 18	990	10 x 16	1022
3 x 10	576	5 x 15	817	7 x 19	1025	10 x 17	1058
3 x 11	611	5 x 16	852	7 x 20	1058	10 x 18	1092
3 x 12	645	5 x 17	885			10 x 19	1128
3 x 13	678	5 x 18	922	8 x 8	678	10 x 20	1160
3 x 14	716	5 x 19	954	8 x 9	714		
3 x 15	748	5 x 20	990	8 x 10	748		
3 x 16	783			8 x 11	783		
3 x 17	817			8 x 12	817		
3 x 18	852			8 x 13	852		
3 x 19	887						
3 x 20	922						

Kits Include:

- Mill Finish (Portions of the Insert Panel System are anodized for sliding purposes only)
- Cut to size and mitered bodies
- Cut to size and mitered frames with covers
- Cut to size insert panels, adaptors and divider (Insert Panel System kits only)
- All screws required to assemble by mechanical fastening
- All Corner Angles and/or Corner Keys required
- Packaging

Not Included in Kits:

- Face or Back
- Electrical Components
- Divider(s) - See optional accessories
- Back Braces and Gussets
- Mounting Provisions

Optional Accessories (pg 127):

- Divider(s)

Kit Specifications:

- **Recommended for LED applications**
- Custom size kits may be cut to any dimension
- Commercial Access Frame integrates with all Architectural Covers and Insert Panel System

Divider Kits Include:

- Cut to size dividers
- Divider Tabs
- All screws required to assemble by mechanical fastening
- **1-1/4" Divider, Part #1662, \$5.81 per/ft per/face**
- For use with Slide and Radius Slide Covers

Additional Information (pgs 196-197)

Note: All dimensions are subject to the tolerance standards of the aluminum extrusion industry. Profile drawings are illustrative and rounded to the nearest 1/16".

CURRENT PRICE as of April 1, 2022



COMMERCIAL

Unassembled Single Face Kits w/ Reveal - For Insert Panels

Single Face Body w/ Commercial Access Frame and Cover Options

Part #2025

Part #2060

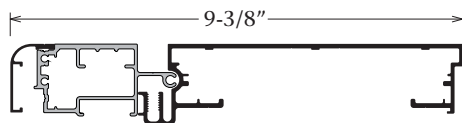

Slide
Part #1694
KSF/60/94



Radius Slide
Part #1695
KSF/60/95



Bleed
Part #1692
KSF/60/92



Frameless
Part #1693
KSF/60/93



* Insert Top/Bottom
Part #1292
KSF/60/92/98

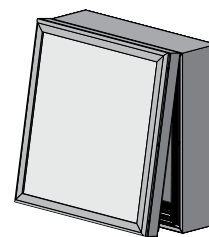

Size H'xW'	Mill Finish	Size H'xW'	Mill Finish	Size H'xW'	Mill Finish	Size H'xW'	Mill Finish
2 x 3	\$361	4 x 4	\$478	6 x 6	\$639	8 x 14	\$1042
2 x 4	399	4 x 5	519	6 x 7	678	8 x 15	1082
2 x 5	439	4 x 6	560	6 x 8	720	8 x 16	1121
2 x 6	478	4 x 7	598	6 x 9	758	8 x 17	1164
2 x 7	519	4 x 8	639	6 x 10	799	8 x 18	1202
2 x 8	560	4 x 9	678	6 x 11	840	8 x 19	1243
2 x 9	598	4 x 10	720	6 x 12	880	8 x 20	1284
2 x 10	639	4 x 11	758	6 x 13	922		
2 x 11	678	4 x 12	800	6 x 14	960	9 x 9	880
2 x 12	720	4 x 13	840	6 x 15	1002	9 x 10	922
2 x 13	760	4 x 14	880	6 x 16	1042	9 x 11	960
2 x 14	800	4 x 15	922	6 x 17	1083	9 x 12	1002
2 x 15	840	4 x 16	960	6 x 18	1121	9 x 13	1041
2 x 16	880	4 x 17	1002	6 x 19	1164	9 x 14	1082
2 x 17	922	4 x 18	1042	6 x 20	1202	9 x 15	1121
2 x 18	960	4 x 19	1083			9 x 16	1164
2 x 19	1002	4 x 20	1121	7 x 7	720	9 x 17	1202
2 x 20	1042			7 x 8	758	9 x 18	1243
		5 x 5	560	7 x 9	799	9 x 19	1284
3 x 3	399	5 x 6	598	7 x 10	840	9 x 20	1324
3 x 4	439	5 x 7	639	7 x 11	880		
3 x 5	478	5 x 8	678	7 x 12	922	10 x 10	960
3 x 6	519	5 x 9	720	7 x 13	960	10 x 11	1002
3 x 7	560	5 x 10	758	7 x 14	1002	10 x 12	1041
3 x 8	598	5 x 11	799	7 x 15	1042	10 x 13	1082
3 x 9	639	5 x 12	840	7 x 16	1083	10 x 14	1121
3 x 10	678	5 x 13	880	7 x 17	1121	10 x 15	1164
3 x 11	720	5 x 14	922	7 x 18	1164	10 x 16	1202
3 x 12	760	5 x 15	960	7 x 19	1202	10 x 17	1243
3 x 13	800	5 x 16	1002	7 x 20	1243	10 x 18	1284
3 x 14	840	5 x 17	1042			10 x 19	1324
3 x 15	880	5 x 18	1083	8 x 8	799	10 x 20	1362
3 x 16	922	5 x 19	1121	8 x 9	840		
3 x 17	960	5 x 20	1164	8 x 10	880		
3 x 18	1002			8 x 11	922		
3 x 19	1042			8 x 12	960		
3 x 20	1083			8 x 13	1002		

Kits Include:

- Mill Finish (Portions of the Insert Panel System are anodized for sliding purposes only)
- Cut to size and mitered bodies
- Cut to size and mitered frames with covers
- Cut to size insert panels, adaptors and divider (Insert Panel System kits only)
- All screws required to assemble by mechanical fastening
- All Corner Angles and/or Corner Keys required
- Packaging

Not Included in kits:

- Face or Back
- Electrical Components
- Ballast Bracket(s) - See optional accessories
- Back Braces and Gussets
- Raceway Covers and Cover Screws - See optional accessories
- Divider(s) - See optional accessories
- Mounting Provisions

Optional Accessories (pg 127):

- Ballast Bracket(s)
- Raceway Covers and Cover Screws
- Divider(s)

Kit Specifications:

- It is recommended to order kits 1" over nominal T12 or T8 lamp size to utilize .040 flat Aluminum Raceway Covers
- Custom size kits may be cut to any dimension
- Commercial Access Frame integrates with all Architectural Covers and Insert Panel System

Recommended Lamp Spacing:

- For illuminated backgrounds - 12" on center, using T12 or T8 lamps
- Always place lamps 3/4" from back of sign

Divider Kits Include:

- Cut to size dividers
- Divider Tabs
- All screws required to assemble by mechanical fastening
- 1-1/4" Divider, Part #1662, \$5.81 per/ft per/face
- For use with Slide and Radius Slide Covers

Additional Information (pgs 196-197)

Note: It is recommended to use safety chains and prop-bars on all hingeable faces.

*Call SignComp Customer Service for Insert Panel pricing





Unassembled Double Face Kits w/ Reveal - For Insert Panels

Medium Body w/ Commercial Access Frame and Cover Options

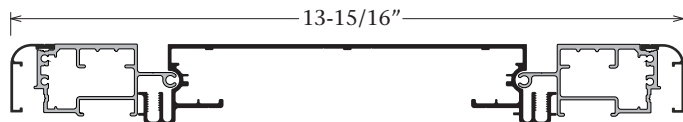
Part #2015

Part #2060



- 
 Slide
 Part #1694
 KMB/60/94
- 
 Radius Slide
 Part #1695
 KMB/60/95
- 
 Bleed
 Part #1692
 KMB/60/92
- 
 Frameless
 Part #1693
 KMB/60/93
- 
 *
 Insert Top/Bottom
 Part #1292
 KMB/60/92/98

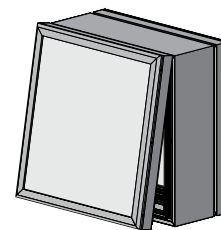

Size H'xW'	Mill Finish	Size H'xW'	Mill Finish	Size H'xW'	Mill Finish	Size H'xW'	Mill Finish
2 x 3	\$587	4 x 4	\$783	6 x 6	\$1046	8 x 14	\$1709
2 x 4	651	4 x 5	849	6 x 7	1113	8 x 15	1776
2 x 5	718	4 x 6	915	6 x 8	1180	8 x 16	1841
2 x 6	783	4 x 7	981	6 x 9	1244	8 x 17	1910
2 x 7	849	4 x 8	1046	6 x 10	1312	8 x 18	1973
2 x 8	915	4 x 9	1113	6 x 11	1378	8 x 19	2040
2 x 9	981	4 x 10	1180	6 x 12	1443	8 x 20	2107
2 x 10	1046	4 x 11	1244	6 x 13	1510		
2 x 11	1113	4 x 12	1312	6 x 14	1576	9 x 9	1443
2 x 12	1180	4 x 13	1378	6 x 15	1641	9 x 10	1510
2 x 13	1244	4 x 14	1443	6 x 16	1709	9 x 11	1576
2 x 14	1312	4 x 15	1510	6 x 17	1776	9 x 12	1641
2 x 15	1378	4 x 16	1577	6 x 18	1841	9 x 13	1709
2 x 16	1443	4 x 17	1641	6 x 19	1910	9 x 14	1776
2 x 17	1510	4 x 18	1709	6 x 20	1973	9 x 15	1841
2 x 18	1577	4 x 19	1776			9 x 16	1910
2 x 19	1641	4 x 20	1841	7 x 7	1180	9 x 17	1973
2 x 20	1711			7 x 8	1244	9 x 18	2040
		5 x 5	915	7 x 9	1312	9 x 19	2107
3 x 3	651	5 x 6	981	7 x 10	1378	9 x 20	2174
3 x 4	718	5 x 7	1046	7 x 11	1443		
3 x 5	783	5 x 8	1113	7 x 12	1510	10 x 10	1576
3 x 6	849	5 x 9	1180	7 x 13	1576	10 x 11	1641
3 x 7	915	5 x 10	1244	7 x 14	1641	10 x 12	1709
3 x 8	981	5 x 11	1312	7 x 15	1709	10 x 13	1776
3 x 9	1046	5 x 12	1378	7 x 16	1776	10 x 14	1841
3 x 10	1113	5 x 13	1443	7 x 17	1841	10 x 15	1910
3 x 11	1180	5 x 14	1510	7 x 18	1910	10 x 16	1973
3 x 12	1244	5 x 15	1577	7 x 19	1973	10 x 17	2040
3 x 13	1312	5 x 16	1641	7 x 20	2040	10 x 18	2107
3 x 14	1378	5 x 17	1709			10 x 19	2174
3 x 15	1443	5 x 18	1776	8 x 8	1312	10 x 20	2234
3 x 16	1510	5 x 19	1841	8 x 9	1378		
3 x 17	1577	5 x 20	1910	8 x 10	1443		
3 x 18	1641			8 x 11	1510		
3 x 19	1711			8 x 12	1576		
3 x 20	1776			8 x 13	1641		

Kits Include:

- Mill Finish (Portions of the Insert Panel System are anodized for sliding purposes only)
- Cut to size and mitered bodies
- Cut to size and mitered frames with covers
- Cut to size insert panels, adaptors and divider (Insert Panel System kits only)
- All screws required to assemble by mechanical fastening
- All Corner Angles and/or Corner Keys required
- Packaging

Not Included in Kits:

- Faces
- Electrical Components
- Ballast Bracket(s) - See optional accessories
- Internal Supports
- Raceway Covers - See optional accessories
- Divider(s) - See optional accessories

Optional Accessories (pg 127):

- Ballast Bracket(s)
- Raceway Covers and Cover Screws
- Divider(s)

Kit Specifications:

- It is recommended to order kits 1" over nominal T12 or T8 lamp size to utilize .040 flat Aluminum Raceway Covers
- Custom size kits may be cut to any dimension
- Commercial Access Frame integrates with all Architectural Covers and Insert Panel System

Recommended Lamp Spacing:

- For illuminated backgrounds - 12" on center, using T12 or T8 lamps

Divider Kits Include:

- Cut to size dividers
- Divider Tabs
- All screws required to assemble by mechanical fastening
- 1-1/4" Divider, Part #1662, \$5.81 per/ft per/face
- For use with Slide and Radius Slide Covers

Additional Information (pgs 196-197)

Note: All dimensions are subject to the tolerance standards of the aluminum extrusion industry. Profile drawings are illustrative and rounded to the nearest 1/16".

CURRENT PRICE as of April 1, 2022



COMMERCIAL

Unassembled Double Face Kits w/ Reveal - For Insert Panels

Wide Body w/ Commercial Access Frame and Cover Options

Part #2005

Part #2060

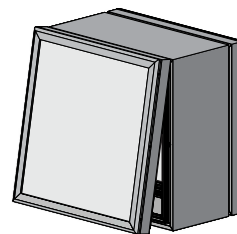
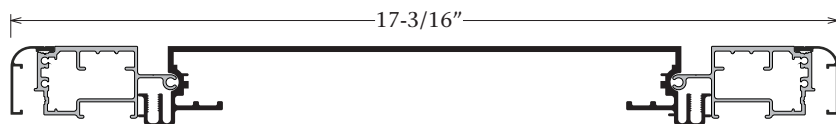

Slide
Part #1694
KWB/60/94



Radius Slide
Part #1695
KWB/60/95



Bleed
Part #1692
KWB/60/92



Frameless
Part #1693
KWB/60/93



* Insert Top/Bottom
Part #1292
KWB/60/92/98

Size H'xW'	Mill Finish	Size H'xW'	Mill Finish	Size H'xW'	Mill Finish	Size H'xW'	Mill Finish
2 x 3	\$706	4 x 4	\$947	6 x 6	\$1268	8 x 14	\$2077
2 x 4	785	4 x 5	1027	6 x 7	1350	8 x 15	2158
2 x 5	867	4 x 6	1109	6 x 8	1431	8 x 16	2237
2 x 6	947	4 x 7	1189	6 x 9	1510	8 x 17	2322
2 x 7	1027	4 x 8	1269	6 x 10	1590	8 x 18	2400
2 x 8	1109	4 x 9	1350	6 x 11	1672	8 x 19	2481
2 x 9	1189	4 x 10	1431	6 x 12	1754	8 x 20	2563
2 x 10	1269	4 x 11	1510	6 x 13	1835		
2 x 11	1350	4 x 12	1590	6 x 14	1914	9 x 9	1754
2 x 12	1431	4 x 13	1672	6 x 15	1996	9 x 10	1835
2 x 13	1510	4 x 14	1754	6 x 16	2077	9 x 11	1914
2 x 14	1590	4 x 15	1835	6 x 17	2158	9 x 12	1996
2 x 15	1672	4 x 16	1914	6 x 18	2237	9 x 13	2077
2 x 16	1754	4 x 17	1996	6 x 19	2322	9 x 14	2158
2 x 17	1835	4 x 18	2077	6 x 20	2400	9 x 15	2237
2 x 18	1914	4 x 19	2158			9 x 16	2321
2 x 19	1996	4 x 20	2237	7 x 7	1431	9 x 17	2400
2 x 20	2077			7 x 8	1510	9 x 18	2481
		5 x 5	1109	7 x 9	1590	9 x 19	2563
3 x 3	785	5 x 6	1189	7 x 10	1672	9 x 20	2643
3 x 4	867	5 x 7	1269	7 x 11	1754		
3 x 5	947	5 x 8	1350	7 x 12	1835	10 x 10	1914
3 x 6	1027	5 x 9	1431	7 x 13	1914	10 x 11	1996
3 x 7	1109	5 x 10	1510	7 x 14	1996	10 x 12	2077
3 x 8	1189	5 x 11	1590	7 x 15	2077	10 x 13	2158
3 x 9	1269	5 x 12	1672	7 x 16	2158	10 x 14	2237
3 x 10	1350	5 x 13	1754	7 x 17	2237	10 x 15	2321
3 x 11	1431	5 x 14	1835	7 x 18	2322	10 x 16	2400
3 x 12	1510	5 x 15	1914	7 x 19	2400	10 x 17	2481
3 x 13	1590	5 x 16	1996	7 x 20	2481	10 x 18	2563
3 x 14	1672	5 x 17	2077			10 x 19	2643
3 x 15	1754	5 x 18	2158	8 x 8	1590	10 x 20	2718
3 x 16	1835	5 x 19	2237	8 x 9	1672		
3 x 17	1914	5 x 20	2322	8 x 10	1754		
3 x 18	1996			8 x 11	1835		
3 x 19	2077			8 x 12	1914		
3 x 20	2158			8 x 13	1996		

Kits Include:

- Mill Finish (Portions of the Insert Panel System are anodized for sliding purposes only)
- Cut to size and mitered bodies
- Cut to size and mitered frames with covers
- Cut to size insert panel, adaptors and divider (Insert Panel System kits only)
- All screws required to assemble by mechanical fastening
- All Corner Angles and/or Corner Keys required
- Packaging

Not Included in Kits:

- Faces
- Electrical Components
- Ballast Bracket(s) - See optional accessories
- Internal Supports
- Raceway Covers - See optional accessories
- Divider(s) - See optional accessories

Optional Accessories (pg 127):

- Ballast Bracket(s)
- Raceway Covers and Cover Screws
- Divider(s)

Kit Specifications:

- It is recommended to order kits 1" over nominal T12 or T8 lamp size to utilize .040 flat Aluminum Raceway Covers
- Custom size kits may be cut to any dimension
- Commercial Access Frame integrates with all Architectural Covers and Insert Panel System

Recommended Lamp Spacing:

- For illuminated backgrounds - 12" on center, using T12 or T8 lamps

Divider Kits Include:

- Cut to size dividers
- Divider Tabs
- All screws required to assemble by mechanical fastening
- 1-1/4" Divider, Part #1662, \$5.81 per/ft per/face
- For use with Slide and Radius Slide Covers

Additional Information (pgs 196-197)

Note: It is recommended to use safety chains and prop-bars on all hingeable faces.

*Call SignComp Customer Service for Insert Panel pricing

Unassembled Retro Kits w/ Reveal - For Flexible Faces

Retro Body w/ Tension Frame II and Bleed Tension Frame Cover

Part #2040
K2040/86/95

Part #2086

Part #2095

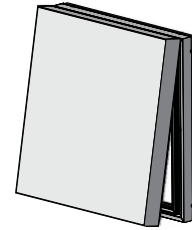
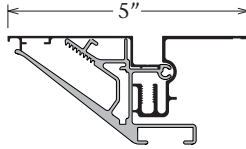

Size H'xW'	Mill Finish	Size H'xW'	Mill Finish	Size H'xW'	Mill Finish	Size H'xW'	Mill Finish
2 x 3	\$425	4 x 4	\$542	6 x 6	\$732	8 x 14	\$1184
2 x 4	463	4 x 5	585	6 x 7	784	8 x 15	1228
2 x 5	507	4 x 6	637	6 x 8	824	8 x 16	1268
2 x 6	560	4 x 7	694	6 x 9	867	8 x 17	1319
2 x 7	611	4 x 8	732	6 x 10	919	8 x 18	1362
2 x 8	648	4 x 9	778	6 x 11	963	8 x 19	1415
2 x 9	698	4 x 10	825	6 x 12	1003	8 x 20	1457
2 x 10	746	4 x 11	867	6 x 13	1053		
2 x 11	792	4 x 12	911	6 x 14	1094	9 x 9	999
2 x 12	831	4 x 13	969	6 x 15	1137	9 x 10	1050
2 x 13	884	4 x 14	1003	6 x 16	1189	9 x 11	1094
2 x 14	922	4 x 15	1049	6 x 17	1229	9 x 12	1132
2 x 15	972	4 x 16	1100	6 x 18	1272	9 x 13	1189
2 x 16	1019	4 x 17	1137	6 x 19	1327	9 x 14	1225
2 x 17	1060	4 x 18	1181	6 x 20	1363	9 x 15	1272
2 x 18	1101	4 x 19	1236			9 x 16	1320
2 x 19	1152	4 x 20	1272	7 x 7	836	9 x 17	1363
2 x 20	1193			7 x 8	874	9 x 18	1404
		5 x 5	625	7 x 9	920	9 x 19	1458
		5 x 6	681	7 x 10	967	9 x 20	1498
3 x 3	469	5 x 7	733	7 x 11	1011		
3 x 4	508	5 x 8	771	7 x 12	1051	10 x 10	1102
3 x 5	550	5 x 9	817	7 x 13	1106	10 x 11	1138
3 x 6	599	5 x 10	867	7 x 14	1144	10 x 12	1184
3 x 7	653	5 x 11	908	7 x 15	1190	10 x 13	1235
3 x 8	694	5 x 12	954	7 x 16	1240	10 x 14	1274
3 x 9	738	5 x 13	1003	7 x 17	1284	10 x 15	1319
3 x 10	792	5 x 14	1041	7 x 18	1325	10 x 16	1371
3 x 11	832	5 x 15	1088	7 x 19	1379	10 x 17	1413
3 x 12	872	5 x 16	1137	7 x 20	1418	10 x 18	1450
3 x 13	924	5 x 17	1178			10 x 19	1507
3 x 14	969	5 x 18	1224	8 x 8	912	10 x 20	1548
3 x 15	1010	5 x 19	1274	8 x 9	956		
3 x 16	1061	5 x 20	1314	8 x 10	997		
3 x 17	1101			8 x 11	1050		
3 x 18	1145			8 x 12	1092		
3 x 19	1196			8 x 13	1132		
3 x 20	1241						

Kits Include:

- Mill Finish
- Cut to size and mitered bodies
- Cut to size and mitered frames with covers
- Tension Clips
- Frame Braces for LED applications (Part #5357)
- All screws required to assemble by mechanical fastening
- All Corner Angles and/or Corner Keys required
- Packaging
- Prices reflect one (1) Retro Body kit, SINGLE FACE APPLICATION

Not Included in Kits:

- Face
- Electrical Components
- Frame Support Tube - See optional accessories
- Tension Tool - See optional accessories
- Mounting Provisions

Optional Accessories (pg 127):

- Frame Support Tube
- Tension Tool

Kit Specifications:

- Kits will be cut .265" larger to fit over existing structure
- Custom size kits may be cut to any dimension
- Flexible Face Preparation - See page 129
- Frame Brace / Frame Support Tube placement - See page 130
- Illumination may vary depending on application
- Tension Frame II is not engineered to integrate with the Divider System

Additional Information (pgs 196-197)



Note: All dimensions are subject to the tolerance standards of the aluminum extrusion industry. Profile drawings are illustrative and rounded to the nearest 1/16".

CURRENT PRICE as of April 1, 2022



COMMERCIAL

Unassembled Single Face Kits w/ Reveal - For Flexible Faces

Slimline Single Face Body w/ Tension Frame II and Bleed Tension Frame Cover

Part #2020
K2020/86/95

Part #2086

Part #2095

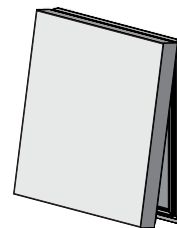
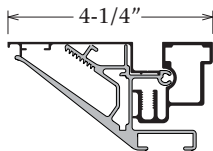

Size H'xW'	Mill Finish	Dk. Bronze	Size H'xW'	Mill Finish	Dk. Bronze	Size H'xW'	Mill Finish	Dk. Bronze	Size H'xW'	Mill Finish	Dk. Bronze
2 x 3	\$437	\$510	4 x 4	\$562	\$654	6 x 6	\$736	\$855	8 x 14	\$1165	\$1348
2 x 4	475	554	4 x 5	603	705	6 x 7	778	903	8 x 15	1212	1403
2 x 5	522	606	4 x 6	648	753	6 x 8	821	954	8 x 16	1255	1446
2 x 6	566	657	4 x 7	698	805	6 x 9	865	1004	8 x 17	1296	1497
2 x 7	607	708	4 x 8	736	855	6 x 10	907	1055	8 x 18	1343	1549
2 x 8	648	753	4 x 9	785	907	6 x 11	956	1102	8 x 19	1382	1598
2 x 9	701	807	4 x 10	824	958	6 x 12	995	1157	8 x 20	1427	1648
2 x 10	738	856	4 x 11	865	1004	6 x 13	1039	1205			
2 x 11	785	907	4 x 12	912	1055	6 x 14	1082	1251	9 x 9	994	1153
2 x 12	827	959	4 x 13	962	1110	6 x 15	1129	1306	9 x 10	1037	1196
2 x 13	871	1011	4 x 14	995	1157	6 x 16	1170	1351	9 x 11	1082	1251
2 x 14	912	1055	4 x 15	1043	1208	6 x 17	1213	1406	9 x 12	1122	1299
2 x 15	963	1113	4 x 16	1088	1255	6 x 18	1259	1454	9 x 13	1170	1351
2 x 16	1003	1158	4 x 17	1129	1306	6 x 19	1303	1504	9 x 14	1209	1400
2 x 17	1043	1208	4 x 18	1176	1356	6 x 20	1344	1550	9 x 15	1259	1454
2 x 18	1089	1257	4 x 19	1220	1407				9 x 16	1299	1500
2 x 19	1132	1311	4 x 20	1259	1454	7 x 7	821	954	9 x 17	1344	1550
2 x 20	1176	1356				7 x 8	860	995	9 x 18	1388	1602
			5 x 5	648	753	7 x 9	911	1054	9 x 19	1430	1651
3 x 3	483	563	5 x 6	693	804	7 x 10	950	1100	9 x 20	1471	1702
3 x 4	523	607	5 x 7	738	856	7 x 11	994	1153			
3 x 5	567	658	5 x 8	778	903	7 x 12	1038	1199	10 x 10	1079	1248
3 x 6	607	708	5 x 9	827	959	7 x 13	1083	1253	10 x 11	1118	1295
3 x 7	653	760	5 x 10	865	1004	7 x 14	1122	1299	10 x 12	1165	1348
3 x 8	698	805	5 x 11	911	1054	7 x 15	1172	1355	10 x 13	1208	1393
3 x 9	744	862	5 x 12	959	1106	7 x 16	1212	1403	10 x 14	1249	1441
3 x 10	785	907	5 x 13	995	1157	7 x 17	1259	1454	10 x 15	1296	1497
3 x 11	828	960	5 x 14	1039	1205	7 x 18	1302	1502	10 x 16	1339	1544
3 x 12	871	1011	5 x 15	1088	1255	7 x 19	1346	1554	10 x 17	1381	1595
3 x 13	915	1060	5 x 16	1129	1306	7 x 20	1388	1602	10 x 18	1422	1644
3 x 14	962	1110	5 x 17	1172	1355				10 x 19	1470	1700
3 x 15	1006	1162	5 x 18	1220	1407	8 x 8	903	1045	10 x 20	1513	1740
3 x 16	1045	1209	5 x 19	1263	1455	8 x 9	950	1100			
3 x 17	1089	1257	5 x 20	1302	1502	8 x 10	991	1145			
3 x 18	1134	1312				8 x 11	1037	1196			
3 x 19	1177	1358				8 x 12	1081	1249			
3 x 20	1225	1410				8 x 13	1122	1299			

Kits Include:

- Mill Finish or Dk. Bronze
- Cut to size and mitered bodies
- Cut to size and mitered frames with covers
- Tension Clips
- Frame Angles (Part #5300)
- All screws required to assemble by mechanical fastening
- All Corner Angles and/or Corner Keys required
- Packaging

Not Included in Kits:

- Face or Back
- Electrical Components
- Back Braces and Gussets
- Frame Support Tube - See optional accessories
- Tension Tool - See optional accessories
- Mounting Provisions

Optional Accessories (pg 127):

- Frame Support Tube
- Tension Tool

Kit Specifications:

- **Recommended for LED applications**
- Custom size kits may be cut to any dimension
- Flexible Face Preparation - See page 129
- Frame Brace / Frame Support Tube placement - See page 130
- Tension Frame II is not engineered to integrate with the Divider System

Additional Information (pgs 196-197)

UL Recognized Component Systems
The Underwriters Laboratory file number is E136850

Note: It is recommended to use safety chains and prop-bars on all hingeable faces.

US Patent Numbers 6,061,941 / 6,637,080
CA Patent Numbers 2,245,623 / 2,387,222

Unassembled Single Face Kits w/ Reveal - For Flexible Faces

Narrow Single Face Body w/ Tension Frame II and Bleed Tension Frame Cover

Part #2021
K2021/86/95

Part #2086

Part #2095

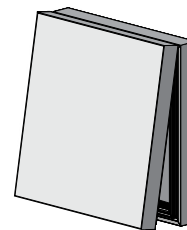
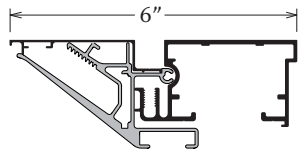

Size H'xW'	Mill Finish	Dk. Bronze	Size H'xW'	Mill Finish	Dk. Bronze	Size H'xW'	Mill Finish	Dk. Bronze	Size H'xW'	Mill Finish	Dk. Bronze
2 x 3	\$460	\$544	4 x 4	\$601	\$710	6 x 6	\$799	\$944	8 x 14	\$1284	\$1518
2 x 4	503	597	4 x 5	651	773	6 x 7	847	1002	8 x 15	1336	1578
2 x 5	555	655	4 x 6	699	828	6 x 8	896	1060	8 x 16	1387	1629
2 x 6	606	717	4 x 7	753	887	6 x 9	944	1117	8 x 17	1432	1688
2 x 7	654	776	4 x 8	799	944	6 x 10	992	1176	8 x 18	1483	1751
2 x 8	699	828	4 x 9	853	1004	6 x 11	1045	1233	8 x 19	1530	1806
2 x 9	756	888	4 x 10	897	1061	6 x 12	1092	1293	8 x 20	1580	1863
2 x 10	800	947	4 x 11	944	1117	6 x 13	1141	1348	9 x 9	1090	1291
2 x 11	853	1004	4 x 12	995	1176	6 x 14	1189	1403	9 x 10	1137	1343
2 x 12	900	1065	4 x 13	1053	1239	6 x 15	1241	1469	9 x 11	1189	1403
2 x 13	950	1125	4 x 14	1092	1293	6 x 16	1290	1522	9 x 12	1236	1458
2 x 14	995	1176	4 x 15	1146	1351	6 x 17	1339	1581	9 x 13	1290	1522
2 x 15	1054	1241	4 x 16	1195	1409	6 x 18	1390	1639	9 x 14	1332	1577
2 x 16	1098	1295	4 x 17	1241	1469	6 x 19	1439	1697	9 x 15	1390	1639
2 x 17	1146	1351	4 x 18	1295	1525	6 x 20	1485	1752	9 x 16	1434	1692
2 x 18	1196	1410	4 x 19	1344	1585	7 x 7	896	1060	9 x 17	1485	1752
2 x 19	1244	1470	4 x 20	1390	1639	7 x 8	939	1110	9 x 18	1533	1809
2 x 20	1295	1525				7 x 9	994	1174	9 x 19	1581	1866
			5 x 5	699	828	7 x 10	1039	1228	9 x 20	1630	1925
3 x 3	511	603	5 x 6	750	885	7 x 11	1090	1291			
3 x 4	559	658	5 x 7	800	947	7 x 12	1138	1344	10 x 10	1186	1400
3 x 5	607	718	5 x 8	847	1002	7 x 13	1190	1406	10 x 11	1233	1454
3 x 6	654	776	5 x 9	900	1065	7 x 14	1236	1458	10 x 12	1284	1518
3 x 7	704	832	5 x 10	944	1117	7 x 15	1291	1523	10 x 13	1331	1570
3 x 8	753	887	5 x 11	994	1174	7 x 16	1336	1578	10 x 14	1378	1625
3 x 9	805	951	5 x 12	1051	1236	7 x 17	1390	1639	10 x 15	1432	1688
3 x 10	853	1004	5 x 13	1092	1293	7 x 18	1438	1695	10 x 16	1479	1743
3 x 11	902	1066	5 x 14	1141	1348	7 x 19	1486	1754	10 x 17	1529	1803
3 x 12	950	1125	5 x 15	1195	1409	7 x 20	1533	1809	10 x 18	1576	1861
3 x 13	1002	1181	5 x 16	1241	1469	8 x 8	988	1168	10 x 19	1629	1923
3 x 14	1053	1239	5 x 17	1291	1523	8 x 9	1039	1228	10 x 20	1677	1972
3 x 15	1102	1299	5 x 18	1344	1585	8 x 10	1088	1283			
3 x 16	1148	1354	5 x 19	1391	1640	8 x 11	1137	1343			
3 x 17	1196	1410	5 x 20	1438	1695	8 x 12	1188	1402			
3 x 18	1248	1471				8 x 13	1236	1458			
3 x 19	1296	1526									
3 x 20	1348	1586									

Kits Include:

- Mill Finish or Dk. Bronze
- Cut to size and mitered bodies
- Cut to size and mitered frames with covers
- Tension Clips
- Frame Braces (Part #5352)
- All screws required to assemble by mechanical fastening
- All Corner Angles and/or Corner Keys required
- Packaging

Not Included in Kits:

- Face or Back
- Electrical Component
- Back Braces and Gussets
- Frame Support Tube - See optional accessories
- Tension Tool - See optional accessories
- 6" Radius Corners - See optional accessories
- Mounting Provisions

Optional Accessories (pgs 127-128):

- Frame Support Tube
- Tension Tool
- 6" Radius Corners

Kit Specifications:

- Recommended for LED applications
- Custom size kits may be cut to any dimension
- Flexible Face Preparation - See page 129
- Frame Brace / Frame Support Tube placement - See page 130
- Tension Frame II is not engineered to integrate with the Divider System

Additional Information (pgs 196-197)

Note: All dimensions are subject to the tolerance standards of the aluminum extrusion industry. Profile drawings are illustrative and rounded to the nearest 1/16".

CURRENT PRICE as of April 1, 2022



COMMERCIAL

Unassembled Single Face Kits w/ Reveal - For Flexible Faces

Single Face Body w/ Tension Frame II and Bleed Tension Frame Cover

Part #2025
KSF/86/95

Part #2086

Part #2095

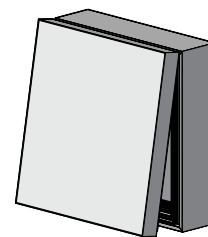
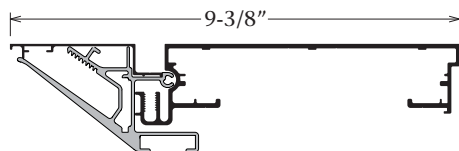

Size H'xW'	Mill Finish	Dk. Bronze	Size H'xW'	Mill Finish	Dk. Bronze	Size H'xW'	Mill Finish	Dk. Bronze	Size H'xW'	Mill Finish	Dk. Bronze
2 x 3	\$471	\$562	4 x 4	\$621	\$742	6 x 6	\$853	\$1013	8 x 14	\$1415	\$1675
2 x 4	519	618	4 x 5	673	805	6 x 7	918	1088	8 x 15	1469	1739
2 x 5	574	682	4 x 6	736	876	6 x 8	967	1149	8 x 16	1522	1793
2 x 6	638	758	4 x 7	805	951	6 x 9	1021	1209	8 x 17	1584	1869
2 x 7	699	831	4 x 8	853	1013	6 x 10	1083	1285	8 x 18	1637	1933
2 x 8	748	888	4 x 9	911	1077	6 x 11	1138	1344	8 x 19	1699	2007
2 x 9	808	953	4 x 10	970	1152	6 x 12	1189	1410	8 x 20	1752	2067
2 x 10	868	1027	4 x 11	1021	1209	6 x 13	1252	1482	9 x 9	1188	1409
2 x 11	923	1090	4 x 12	1074	1274	6 x 14	1303	1541	9 x 10	1249	1477
2 x 12	974	1153	4 x 13	1145	1351	6 x 15	1358	1609	9 x 11	1303	1541
2 x 13	1038	1232	4 x 14	1189	1410	6 x 16	1419	1677	9 x 12	1351	1600
2 x 14	1086	1285	4 x 15	1244	1473	6 x 17	1470	1743	9 x 13	1419	1677
2 x 15	1146	1355	4 x 16	1308	1545	6 x 18	1525	1803	9 x 14	1467	1737
2 x 16	1205	1423	4 x 17	1358	1609	6 x 19	1589	1877	9 x 15	1525	1803
2 x 17	1256	1485	4 x 18	1413	1669	6 x 20	1639	1937	9 x 16	1585	1871
2 x 18	1309	1546	4 x 19	1478	1746	7 x 7	979	1161	9 x 17	1639	1937
2 x 19	1372	1623	4 x 20	1525	1803	7 x 8	1027	1216	9 x 18	1691	1998
2 x 20	1425	1681				7 x 9	1085	1284	9 x 19	1754	2069
			5 x 5	724	865	7 x 10	1145	1355	9 x 20	1804	2135
3 x 3	524	626	5 x 6	790	938	7 x 11	1199	1421	10 x 10	1311	1548
3 x 4	575	683	5 x 7	855	1014	7 x 12	1251	1478	10 x 11	1360	1607
3 x 5	627	748	5 x 8	904	1074	7 x 13	1316	1556	10 x 12	1415	1675
3 x 6	688	820	5 x 9	960	1141	7 x 14	1363	1611	10 x 13	1478	1742
3 x 7	752	895	5 x 10	1021	1209	7 x 15	1422	1680	10 x 14	1528	1802
3 x 8	805	951	5 x 11	1073	1272	7 x 16	1481	1751	10 x 15	1584	1869
3 x 9	859	1019	5 x 12	1130	1335	7 x 17	1537	1815	10 x 16	1645	1940
3 x 10	923	1090	5 x 13	1189	1410	7 x 18	1588	1875	10 x 17	1697	2004
3 x 11	975	1156	5 x 14	1240	1470	7 x 19	1653	1951	10 x 18	1747	2065
3 x 12	1026	1220	5 x 15	1296	1533	7 x 20	1703	2012	10 x 19	1815	2144
3 x 13	1090	1291	5 x 16	1358	1609	8 x 8	1079	1277	10 x 20	1866	2198
3 x 14	1145	1351	5 x 17	1410	1668	8 x 9	1133	1343			
3 x 15	1196	1416	5 x 18	1466	1734	8 x 10	1184	1400			
3 x 16	1257	1486	5 x 19	1526	1804	8 x 11	1249	1477			
3 x 17	1309	1546	5 x 20	1576	1863	8 x 12	1302	1540			
3 x 18	1363	1612				8 x 13	1351	1600			
3 x 19	1426	1683									
3 x 20	1482	1747									

Kits Include:

- Mill Finish or Dk. Bronze
- Cut to size and mitered bodies
- Cut to size and mitered frames with covers
- Tension Clips
- Frame Braces for LED applications (Part #5357)
- All screws required to assemble by mechanical fastening
- All Corner Angles and/or Corner Keys required
- Packaging

Not Included in Kits:

- Face or Back
- Electrical Components
- Ballast Bracket(s) - See optional accessories
- Back Braces and Gussets
- Frame Support Tube - See optional accessories
- Raceway Covers and Cover Screws - See optional accessories
- Tension Tool - See optional accessories
- 6" and 9" Radius Corners - See optional accessories
- Mounting Provisions

Optional Accessories (pgs 127-128):

- Ballast Bracket(s)
- Frame Support Tube
- Raceway Covers and Cover Screws
- Tension Tool
- 6" and 9" Radius Corners

Kit Specifications:

- It is recommended to order kits 1" over nominal T12 or T8 lamp size to utilize .040 flat Aluminum Raceway Covers
- Custom size kits may be cut to any dimension
- Flexible Face Preparation - See page 129
- Frame Brace / Frame Support Tube placement - See page 130
- Tension Frame II is not engineered to integrate with the Divider System

Recommended Lamp Spacing:

- For illuminated backgrounds - 12" on center, using T12 or T8 lamps
- Always place lamps 3/4" from back of sign
- When using lamps, deduct \$6.01 per Frame Brace

Additional Information (pgs 196-197)

UL Recognized Component Systems
The Underwriters Laboratory file number is E136850

Note: It is recommended to use safety chains and prop-bars on all hingeable faces.

US Patent Numbers 6,061,941 / 6,637,080
CA Patent Numbers 2,245,623 / 2,387,222

Unassembled Double Face Kits w/ Reveal - For Flexible Faces

Medium Body w/ Tension Frame II and Bleed Tension Frame Cover

Part #2015
KMB/86/95

Part #2086

Part #2095

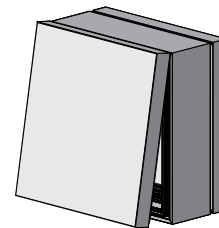
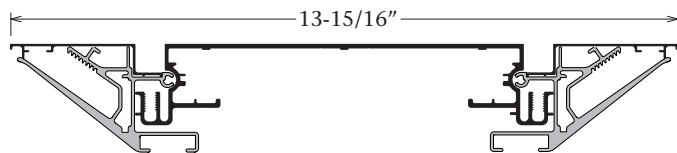

Size H'xW'	Mill Finish	Dk. Bronze	Size H'xW'	Mill Finish	Dk. Bronze	Size H'xW'	Mill Finish	Dk. Bronze	Size H'xW'	Mill Finish	Dk. Bronze
2 x 3	\$729	\$865	4 x 4	\$1014	\$1207	6 x 6	\$1346	\$1609	8 x 14	\$2222	\$2668
2 x 4	825	979	4 x 5	1097	1306	6 x 7	1441	1724	8 x 15	2305	2768
2 x 5	907	1082	4 x 6	1180	1409	6 x 8	1523	1823	8 x 16	2398	2879
2 x 6	990	1183	4 x 7	1272	1520	6 x 9	1605	1923	8 x 17	2483	2982
2 x 7	1086	1296	4 x 8	1356	1621	6 x 10	1700	2037	8 x 18	2564	3082
2 x 8	1168	1397	4 x 9	1441	1724	6 x 11	1784	2139	8 x 19	2659	3193
2 x 9	1251	1498	4 x 10	1534	1835	6 x 12	1866	2238	8 x 20	2742	3296
2 x 10	1346	1611	4 x 11	1616	1935	6 x 13	1962	2354	9 x 9	1866	2238
2 x 11	1430	1712	4 x 12	1700	2036	6 x 14	2044	2454	9 x 10	1961	2353
2 x 12	1513	1815	4 x 13	1794	2149	6 x 15	2127	2555	9 x 11	2044	2454
2 x 13	1605	1925	4 x 14	1877	2250	6 x 16	2222	2668	9 x 12	2127	2555
2 x 14	1688	2026	4 x 15	1961	2353	6 x 17	2306	2769	9 x 13	2222	2668
2 x 15	1772	2128	4 x 16	2053	2463	6 x 18	2388	2869	9 x 14	2305	2768
2 x 16	1867	2242	4 x 17	2139	2566	6 x 19	2483	2982	9 x 15	2388	2869
2 x 17	1951	2342	4 x 18	2222	2668	6 x 20	2564	3082	9 x 16	2483	2982
2 x 18	2035	2442	4 x 19	2314	2778	7 x 7	1533	1835	9 x 17	2564	3082
2 x 19	2128	2556	4 x 20	2398	2879	7 x 8	1616	1935	9 x 18	2647	3182
2 x 20	2212	2659				7 x 9	1699	2036	9 x 19	2742	3297
			5 x 5	1180	1409	7 x 10	1793	2149	9 x 20	2826	3398
3 x 3	824	979	5 x 6	1263	1509	7 x 11	1877	2250	10 x 10	2053	2463
3 x 4	920	1094	5 x 7	1356	1621	7 x 12	1961	2353	10 x 11	2137	2564
3 x 5	1003	1193	5 x 8	1441	1724	7 x 13	2053	2463	10 x 12	2222	2666
3 x 6	1085	1296	5 x 9	1523	1823	7 x 14	2139	2566	10 x 13	2314	2778
3 x 7	1181	1409	5 x 10	1616	1935	7 x 15	2222	2668	10 x 14	2398	2879
3 x 8	1263	1509	5 x 11	1700	2037	7 x 16	2314	2778	10 x 15	2481	2982
3 x 9	1346	1609	5 x 12	1784	2139	7 x 17	2398	2879	10 x 16	2572	3090
3 x 10	1441	1724	5 x 13	1877	2250	7 x 18	2483	2982	10 x 17	2659	3193
3 x 11	1525	1826	5 x 14	1961	2353	7 x 19	2572	3090	10 x 18	2742	3296
3 x 12	1605	1923	5 x 15	2044	2454	7 x 20	2659	3193	10 x 19	2837	3408
3 x 13	1700	2037	5 x 16	2139	2566	8 x 8	1699	2036	10 x 20	2911	3501
3 x 14	1784	2140	5 x 17	2222	2668	8 x 9	1784	2139			
3 x 15	1867	2242	5 x 18	2305	2769	8 x 10	1877	2250			
3 x 16	1962	2354	5 x 19	2398	2879	8 x 11	1961	2353			
3 x 17	2044	2454	5 x 20	2483	2982	8 x 12	2044	2452			
3 x 18	2127	2555				8 x 13	2139	2566			
3 x 19	2223	2668									
3 x 20	2306	2769									

Kits Include:

- Mill Finish or Dk. Bronze
- Cut to size and mitered bodies
- Cut to size and mitered frames with covers
- Tension Clips
- Frame Braces for LED applications (Part #5352)
- All screws required to assemble by mechanical fastening
- All Corner Angles and/or Corner Keys required
- Packaging

Not Included in Kits:

- Faces
- Electrical Components
- Ballast Bracket(s) - See optional accessories
- Internal Supports
- Frame Support Tube - See optional accessories
- Raceway Covers and Cover Screws - See optional accessories
- Tension Tool - See optional accessories
- 6" and 9" Radius Corners - See optional accessories

Optional Accessories (pgs 127-128):

- Ballast Bracket(s)
- Frame Support Tube
- Raceway Covers and Cover Screws
- Tension Tool
- 6" and 9" Radius Corners

Kit Specifications:

- It is recommended to order kits 1" over nominal T12 or T8 lamp size to utilize .040 flat Aluminum Raceway Covers
- Custom size kits may be cut to any dimension
- Flexible Face Preparation - See page 129
- Frame Brace / Frame Support Tube placement - See page 130
- Tension Frame II is not engineered to integrate with the Divider System

Recommended Lamp Spacing:

- For illuminated backgrounds - 12" on center, using T12 or T8 lamps

Additional Information (pgs 196-197)



Note: All dimensions are subject to the tolerance standards of the aluminum extrusion industry. Profile drawings are illustrative and rounded to the nearest 1/16".

CURRENT PRICE as of April 1, 2022



COMMERCIAL

Unassembled Double Face Kits w/ Reveal - For Flexible Faces

Wide Body w/ Tension Frame II and Bleed Tension Frame Cover

Part #2005
KWB/86/95

Part #2086

Part #2095

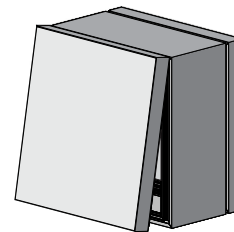
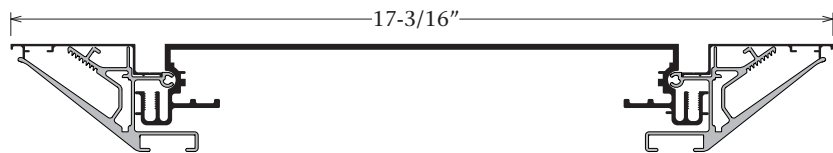

Size H'xW'	Mill Finish	Dk. Bronze	Size H'xW'	Mill Finish	Dk. Bronze	Size H'xW'	Mill Finish	Dk. Bronze	Size H'xW'	Mill Finish	Dk. Bronze
2 x 3	\$825	\$1006	4 x 4	\$1145	\$1398	6 x 6	\$1572	\$1921	8 x 14	\$2659	\$3249
2 x 4	932	1137	4 x 5	1240	1518	6 x 7	1702	2075	8 x 15	2754	3366
2 x 5	1029	1257	4 x 6	1359	1660	6 x 8	1798	2195	8 x 16	2859	3494
2 x 6	1145	1398	4 x 7	1488	1814	6 x 9	1890	2310	8 x 17	2982	3641
2 x 7	1277	1556	4 x 8	1581	1932	6 x 10	2020	2467	8 x 18	3073	3757
2 x 8	1372	1675	4 x 9	1679	2051	6 x 11	2116	2586	8 x 19	3203	3911
2 x 9	1466	1791	4 x 10	1807	2204	6 x 12	2212	2705	8 x 20	3299	4030
2 x 10	1596	1945	4 x 11	1901	2322	6 x 13	2342	2860	9 x 9	2212	2705
2 x 11	1692	2065	4 x 12	1996	2442	6 x 14	2435	2976	9 x 10	2342	2859
2 x 12	1787	2186	4 x 13	2127	2598	6 x 15	2531	3096	9 x 11	2433	2975
2 x 13	1916	2338	4 x 14	2221	2715	6 x 16	2661	3249	9 x 12	2531	3096
2 x 14	2012	2457	4 x 15	2319	2837	6 x 17	2756	3368	9 x 13	2659	3249
2 x 15	2108	2577	4 x 16	2445	2986	6 x 18	2848	3484	9 x 14	2754	3366
2 x 16	2235	2730	4 x 17	2540	3105	6 x 19	2982	3641	9 x 15	2848	3484
2 x 17	2333	2849	4 x 18	2638	3225	6 x 20	3073	3757	9 x 16	2982	3641
2 x 18	2425	2966	4 x 19	2765	3377	7 x 7	1833	2230	9 x 17	3073	3757
2 x 19	2555	3119	4 x 20	2859	3494	7 x 8	1926	2347	9 x 18	3170	3878
2 x 20	2651	3240				7 x 9	2020	2467	9 x 19	3299	4030
			5 x 5	1335	1636	7 x 10	2149	2622	9 x 20	3395	4149
3 x 3	932	1137	5 x 6	1451	1776	7 x 11	2244	2738	10 x 10	2468	3010
3 x 4	1039	1269	5 x 7	1581	1932	7 x 12	2342	2859	10 x 11	2563	3129
3 x 5	1133	1388	5 x 8	1679	2051	7 x 13	2468	3010	10 x 12	2659	3249
3 x 6	1251	1529	5 x 9	1774	2171	7 x 14	2563	3129	10 x 13	2789	3403
3 x 7	1384	1686	5 x 10	1901	2322	7 x 15	2659	3249	10 x 14	2884	3518
3 x 8	1477	1803	5 x 11	1996	2442	7 x 16	2789	3403	10 x 15	2982	3641
3 x 9	1572	1921	5 x 12	2092	2561	7 x 17	2884	3518	10 x 16	3106	3789
3 x 10	1702	2075	5 x 13	2221	2715	7 x 18	2982	3641	10 x 17	3203	3911
3 x 11	1799	2196	5 x 14	2319	2837	7 x 19	3107	3789	10 x 18	3299	4029
3 x 12	1890	2310	5 x 15	2412	2952	7 x 20	3203	3911	10 x 19	3428	4184
3 x 13	2021	2467	5 x 16	2540	3105	8 x 8	2020	2467	10 x 20	3470	4235
3 x 14	2116	2586	5 x 17	2638	3225	8 x 9	2116	2586			
3 x 15	2212	2705	5 x 18	2731	3345	8 x 10	2221	2715			
3 x 16	2342	2860	5 x 19	2859	3495	8 x 11	2342	2859			
3 x 17	2435	2976	5 x 20	2956	3617	8 x 12	2433	2975			
3 x 18	2531	3096				8 x 13	2540	3105			
3 x 19	2661	3250									
3 x 20	2756	3368									

Kits Include:

- Mill Finish or Dk. Bronze
- Cut to size and mitered bodies
- Cut to size and mitered frames with covers
- Tension Clips
- Frame Braces for LED applications (Part #5357)
- All screws required to assemble by mechanical fastening
- All Corner Angles and/or Corner Keys required
- Packaging

Not Included in Kits:

- Faces
- Electrical Components
- Ballast Bracket(s) - See optional accessories
- Internal Supports
- Frame Support Tube - See optional accessories
- Raceway Covers and Cover Screws - See optional accessories
- Tension Tool - See optional accessories
- 6" and 9" Radius Corners - See optional accessories

Optional Accessories (pgs 127-128):

- Ballast Bracket(s)
- Frame Support Tube
- Raceway Covers and Cover Screws
- Tension Tool
- 6" and 9" Radius Corners

Kit Specifications:

- It is recommended to order kits 1" over nominal T12 or T8 lamp size to utilize .040 flat Aluminum Raceway Covers
- Custom size kits may be cut to any dimension
- Flexible Face Preparation - See page 129
- Frame Brace / Frame Support Tube placement - See page 130
- Tension Frame II is not engineered to integrate with the Divider System

Recommended Lamp Spacing:

- For illuminated backgrounds - 12" on center, using T12 or T8 lamps
- When using lamps, deduct \$6.01 per Frame Brace

Additional Information (pgs 196-197)

UL Recognized Component Systems
The Underwriters Laboratory file number is E136850

Note: It is recommended to use safety chains and prop-bars on all hingeable faces.

US Patent Numbers 6,061,941 / 6,637,080
CA Patent Numbers 2,245,623 / 2,387,222

Unassembled Retro Kits w/ Reveal - For Flexible Faces

Retro Body w/ Tension Frame II and 1-1/2" Tension Frame Cover

Part #2040
K2040/86/84

Part #2086

Part #2084

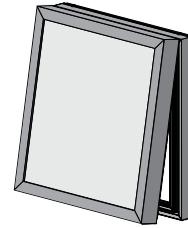
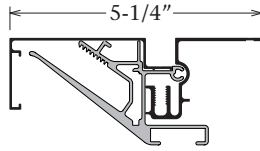

Size H'xW'	Mill Finish	Size H'xW'	Mill Finish	Size H'xW'	Mill Finish	Size H'xW'	Mill Finish
2 x 3	\$440	4 x 4	\$563	6 x 6	\$760	8 x 14	\$1239
2 x 4	483	4 x 5	607	6 x 7	820	8 x 15	1284
2 x 5	523	4 x 6	664	6 x 8	859	8 x 16	1323
2 x 6	579	4 x 7	721	6 x 9	907	8 x 17	1379
2 x 7	633	4 x 8	760	6 x 10	956	8 x 18	1422
2 x 8	674	4 x 9	808	6 x 11	1003	8 x 19	1479
2 x 9	724	4 x 10	860	6 x 12	1042	8 x 20	1525
2 x 10	780	4 x 11	907	6 x 13	1102		
2 x 11	821	4 x 12	950	6 x 14	1141	9 x 9	1043
2 x 12	865	4 x 13	1004	6 x 15	1190	9 x 10	1098
2 x 13	922	4 x 14	1043	6 x 16	1244	9 x 11	1141
2 x 14	962	4 x 15	1092	6 x 17	1288	9 x 12	1184
2 x 15	985	4 x 16	1148	6 x 18	1331	9 x 13	1244
2 x 16	1063	4 x 17	1190	6 x 19	1384	9 x 14	1281
2 x 17	1104	4 x 18	1237	6 x 20	1426	9 x 15	1331
2 x 18	1149	4 x 19	1290			9 x 16	1379
2 x 19	1204	4 x 20	1334	7 x 7	872	9 x 17	1426
2 x 20	1249			7 x 8	911	9 x 18	1466
		5 x 5	651	7 x 9	958	9 x 19	1528
		5 x 6	709	7 x 10	1013	9 x 20	1570
		5 x 7	762	7 x 11	1055		
3 x 3	485	5 x 8	801	7 x 12	1100	10 x 10	1148
3 x 4	528	5 x 9	851	7 x 13	1157	10 x 11	1192
3 x 5	567	5 x 10	903	7 x 14	1196	10 x 12	1239
3 x 6	623	5 x 11	946	7 x 15	1248	10 x 13	1293
3 x 7	677	5 x 12	992	7 x 16	1296	10 x 14	1332
3 x 8	724	5 x 13	1046	7 x 17	1343	10 x 15	1379
3 x 9	769	5 x 14	1088	7 x 18	1381	10 x 16	1434
3 x 10	823	5 x 15	1136	7 x 19	1441	10 x 17	1478
3 x 11	865	5 x 16	1190	7 x 20	1479	10 x 18	1525
3 x 12	912	5 x 17	1236			10 x 19	1581
3 x 13	969	5 x 18	1279	8 x 8	953	10 x 20	1618
3 x 14	1006	5 x 19	1334	8 x 9	1002		
3 x 15	1058	5 x 20	1372	8 x 10	1041		
3 x 16	1105			8 x 11	1098		
3 x 17	1149			8 x 12	1138		
3 x 18	1193			8 x 13	1184		
3 x 19	1253						
3 x 20	1293						

Kits Include:

- Mill Finish
- Cut to size and mitered bodies
- Cut to size and mitered frames with covers
- Tension Clips
- Frame Braces for LED applications (Part #5357)
- All screws required to assemble by mechanical fastening
- All Corner Angles and/or Corner Keys required
- Packaging
- Prices reflect one (1) Retro Body kit, SINGLE FACE APPLICATION

Not Included in Kits:

- Face
- Electrical Components
- Frame Support Tube - See optional accessories
- Tension Tool - See optional accessories
- Mounting Provisions

Optional Accessories (pg 127):

- Frame Support Tube
- Tension Tool

Kit Specifications:

- Kits will be cut .265" larger to fit over existing structure
- Custom size kits may be cut to any dimension
- Flexible Face Preparation - See page 129
- Frame Brace / Frame Support Tube placement - See page 130
- Illumination may vary depending on application
- Tension Frame II is not engineered to integrate with the Divider System

Additional Information (pgs 196-197)



Note: All dimensions are subject to the tolerance standards of the aluminum extrusion industry. Profile drawings are illustrative and rounded to the nearest 1/16".

CURRENT PRICE as of April 1, 2022



COMMERCIAL

Unassembled Single Face Kits w/ Reveal - For Flexible Faces

Slimline Single Face Body w/ Tension Frame II and 1-1/2" Tension Frame Cover

Part #2020
K2020/86/84

Part #2086

Part #2084

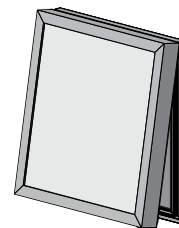
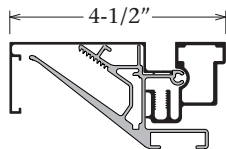

Size H'xW'	Mill Finish	Dk. Bronze	Size H'xW'	Mill Finish	Dk. Bronze	Size H'xW'	Mill Finish	Dk. Bronze	Size H'xW'	Mill Finish	Dk. Bronze
2 x 3	\$450	\$528	4 x 4	\$581	\$681	6 x 6	\$767	\$887	8 x 14	\$1221	\$1413
2 x 4	494	571	4 x 5	627	730	6 x 7	813	943	8 x 15	1269	1473
2 x 5	541	627	4 x 6	676	788	6 x 8	855	991	8 x 16	1312	1520
2 x 6	586	685	4 x 7	722	840	6 x 9	906	1054	8 x 17	1358	1573
2 x 7	629	738	4 x 8	767	887	6 x 10	947	1104	8 x 18	1403	1625
2 x 8	674	785	4 x 9	817	947	6 x 11	995	1157	8 x 19	1450	1679
2 x 9	728	843	4 x 10	857	995	6 x 12	1038	1205	8 x 20	1498	1731
2 x 10	771	895	4 x 11	906	1054	6 x 13	1089	1263			
2 x 11	817	947	4 x 12	953	1106	6 x 14	1130	1314	9 x 9	1039	1205
2 x 12	862	1003	4 x 13	998	1160	6 x 15	1181	1371	9 x 10	1085	1257
2 x 13	911	1055	4 x 14	1039	1205	6 x 16	1228	1421	9 x 11	1130	1314
2 x 14	953	1106	4 x 15	1090	1264	6 x 17	1274	1474	9 x 12	1177	1362
2 x 15	981	1142	4 x 16	1137	1316	6 x 18	1318	1528	9 x 13	1228	1421
2 x 16	1046	1213	4 x 17	1181	1371	6 x 19	1363	1577	9 x 14	1265	1469
2 x 17	1090	1264	4 x 18	1233	1423	6 x 20	1407	1629	9 x 15	1318	1528
2 x 18	1138	1319	4 x 19	1275	1477				9 x 16	1358	1573
2 x 19	1183	1374	4 x 20	1323	1529	7 x 7	857	995	9 x 17	1407	1629
2 x 20	1233	1423				7 x 8	900	1043	9 x 18	1450	1679
			5 x 5	674	785	7 x 9	950	1105	9 x 19	1501	1739
3 x 3	496	579	5 x 6	722	840	7 x 10	994	1150	9 x 20	1546	1786
3 x 4	544	631	5 x 7	768	890	7 x 11	1039	1205			
3 x 5	586	685	5 x 8	809	938	7 x 12	1086	1260	10 x 10	1125	1303
3 x 6	631	742	5 x 9	860	999	7 x 13	1133	1315	10 x 11	1172	1358
3 x 7	677	789	5 x 10	903	1045	7 x 14	1177	1362	10 x 12	1221	1413
3 x 8	728	843	5 x 11	950	1105	7 x 15	1232	1422	10 x 13	1265	1469
3 x 9	774	902	5 x 12	998	1160	7 x 16	1269	1473	10 x 14	1311	1516
3 x 10	820	948	5 x 13	1042	1211	7 x 17	1318	1528	10 x 15	1358	1573
3 x 11	862	1003	5 x 14	1086	1260	7 x 18	1362	1576	10 x 16	1402	1624
3 x 12	912	1057	5 x 15	1137	1316	7 x 19	1409	1632	10 x 17	1449	1677
3 x 13	959	1110	5 x 16	1181	1371	7 x 20	1450	1679	10 x 18	1498	1731
3 x 14	999	1162	5 x 17	1232	1422				10 x 19	1546	1786
3 x 15	1054	1218	5 x 18	1275	1477	8 x 8	943	1094	10 x 20	1586	1835
3 x 16	1092	1265	5 x 19	1323	1529	8 x 9	994	1150			
3 x 17	1138	1319	5 x 20	1363	1577	8 x 10	1037	1199			
3 x 18	1184	1375				8 x 11	1085	1257			
3 x 19	1236	1430				8 x 12	1129	1311			
3 x 20	1277	1478				8 x 13	1177	1362			

Kits Include:

- Mill Finish or Dk. Bronze
- Cut to size and mitered bodies
- Cut to size and mitered frames with covers
- Tension Clips
- Frame Angles (Part #5300)
- All screws required to assemble by mechanical fastening
- All Corner Angles and/or Corner Keys required
- Packaging

Not Included in Kits:

- Face or Back
- Electrical Components
- Back Braces and Gussets
- Frame Support Tube - See optional accessories
- Tension Tool - See optional accessories
- Mounting Provisions

Optional Accessories (pg 127):

- Frame Support Tube
- Tension Tool

Kit Specifications:

- Recommended for LED applications
- Custom size kits may be cut to any dimension
- Flexible Face Preparation - See page 129
- Frame Brace / Frame Support Tube placement - See page 130
- Tension Frame II is not engineered to integrate with the Divider System

Additional Information (pgs 196-197)

UL Recognized Component Systems
The Underwriters Laboratory file number is E136850

Note: It is recommended to use safety chains and prop-bars on all hingeable faces.

US Patent Numbers 6,061,941 / 6,637,080
CA Patent Numbers 2,245,623 / 2,387,222

Unassembled Single Face Kits w/ Reveal - For Flexible Faces

Narrow Single Face Body w/ Tension Frame II and 1-1/2" Tension Frame Cover

Part #2021
K2021/86/84

Part #2086

Part #2084

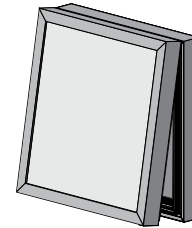
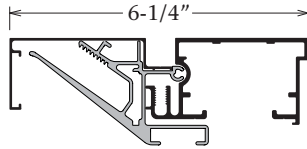

Size H'xW'	Mill Finish	Dk. Bronze	Size H'xW'	Mill Finish	Dk. Bronze	Size H'xW'	Mill Finish	Dk. Bronze	Size H'xW'	Mill Finish	Dk. Bronze
2 x 3	\$474	\$564	4 x 4	\$622	\$740	6 x 6	\$829	\$978	8 x 14	\$1342	\$1581
2 x 4	523	615	4 x 5	674	797	6 x 7	884	1041	8 x 15	1394	1651
2 x 5	575	678	4 x 6	728	862	6 x 8	931	1098	8 x 16	1442	1705
2 x 6	626	745	4 x 7	781	923	6 x 9	987	1168	8 x 17	1495	1764
2 x 7	676	807	4 x 8	829	978	6 x 10	1034	1225	8 x 18	1545	1828
2 x 8	725	860	4 x 9	885	1043	6 x 11	1088	1287	8 x 19	1600	1889
2 x 9	784	927	4 x 10	932	1102	6 x 12	1136	1343	8 x 20	1652	1948
2 x 10	835	985	4 x 11	987	1168	6 x 13	1192	1407	9 x 9	1137	1343
2 x 11	885	1043	4 x 12	1038	1228	6 x 14	1239	1467	9 x 10	1188	1403
2 x 12	936	1109	4 x 13	1089	1290	6 x 15	1295	1532	9 x 11	1239	1467
2 x 13	990	1170	4 x 14	1137	1343	6 x 16	1348	1589	9 x 12	1291	1523
2 x 14	1038	1228	4 x 15	1193	1409	6 x 17	1400	1652	9 x 13	1348	1589
2 x 15	1090	1291	4 x 16	1244	1470	6 x 18	1450	1712	9 x 14	1391	1648
2 x 16	1144	1351	4 x 17	1295	1532	6 x 19	1500	1771	9 x 15	1450	1712
2 x 17	1193	1409	4 x 18	1351	1593	6 x 20	1550	1831	9 x 16	1495	1764
2 x 18	1248	1473	4 x 19	1402	1653	7 x 7	932	1102	9 x 17	1550	1831
2 x 19	1297	1534	4 x 20	1453	1715	7 x 8	981	1158	9 x 18	1600	1889
2 x 20	1351	1593				7 x 9	1035	1227	9 x 19	1655	1957
			5 x 5	725	860	7 x 10	1086	1283	9 x 20	1705	2012
3 x 3	526	623	5 x 6	781	923	7 x 11	1137	1343	10 x 10	1235	1458
3 x 4	579	683	5 x 7	831	982	7 x 12	1189	1406	10 x 11	1287	1520
3 x 5	626	745	5 x 8	880	1038	7 x 13	1241	1469	10 x 12	1342	1581
3 x 6	678	808	5 x 9	935	1105	7 x 14	1291	1523	10 x 13	1391	1648
3 x 7	730	863	5 x 10	983	1160	7 x 15	1350	1590	10 x 14	1441	1702
3 x 8	784	927	5 x 11	1035	1227	7 x 16	1394	1651	10 x 15	1495	1764
3 x 9	837	991	5 x 12	1089	1290	7 x 17	1450	1712	10 x 16	1544	1826
3 x 10	887	1045	5 x 13	1138	1347	7 x 18	1498	1770	10 x 17	1598	1886
3 x 11	936	1109	5 x 14	1189	1406	7 x 19	1553	1833	10 x 18	1652	1948
3 x 12	991	1172	5 x 15	1244	1470	7 x 20	1600	1889	10 x 19	1705	2012
3 x 13	1043	1232	5 x 16	1295	1532	8 x 8	1030	1216	10 x 20	1752	2068
3 x 14	1090	1291	5 x 17	1350	1590	8 x 9	1086	1283			
3 x 15	1150	1356	5 x 18	1402	1653	8 x 10	1134	1339			
3 x 16	1195	1410	5 x 19	1453	1715	8 x 11	1188	1403			
3 x 17	1248	1473	5 x 20	1500	1771	8 x 12	1237	1465			
3 x 18	1299	1537				8 x 13	1291	1523			
3 x 19	1355	1600									
3 x 20	1403	1655									

Kits Include:

- Mill Finish or Dk. Bronze
- Cut to size and mitered bodies
- Cut to size and mitered frames with covers
- Tension Clips
- Frame Braces (Part #5352)
- All screws required to assemble by mechanical fastening
- All Corner Angles and/or Corner Keys required
- Packaging

Not Included in Kits:

- Face or Back
- Electrical Components
- Back Braces and Gussets
- Frame Support Tube - See optional accessories
- Tension Tool - See optional accessories
- Mounting Provisions

Optional Accessories (pg 127):

- Frame Support Tube
- Tension Tool

Kit Specifications:

- **Recommended for LED applications**
- Custom size kits may be cut to any dimension
- Flexible Face Preparation - See page 129
- Frame Brace / Frame Support Tube placement - See page 130
- Tension Frame II is not engineered to integrate with the Divider System

Additional Information (pgs 196-197)

Note: All dimensions are subject to the tolerance standards of the aluminum extrusion industry. Profile drawings are illustrative and rounded to the nearest 1/16".

CURRENT PRICE as of April 1, 2022



COMMERCIAL

Unassembled Single Face Kits w/ Reveal - For Flexible Faces

Single Face Body w/ Tension Frame II and 1-1/2" Tension Frame Cover

Part #2025
KSF/86/84

Part #2086

Part #2084

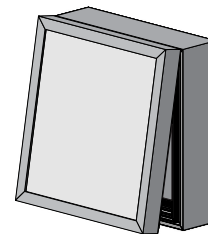
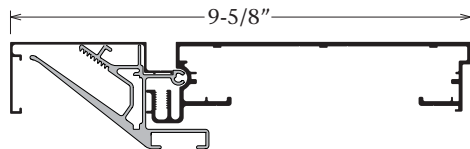

Size H'xW'	Mill Finish	Dk. Bronze	Size H'xW'	Mill Finish	Dk. Bronze	Size H'xW'	Mill Finish	Dk. Bronze	Size H'xW'	Mill Finish	Dk. Bronze
2 x 3	\$487	\$581	4 x 4	\$642	\$769	6 x 6	\$883	\$1045	8 x 14	\$1471	\$1739
2 x 4	538	637	4 x 5	698	831	6 x 7	953	1126	8 x 15	1528	1810
2 x 5	592	704	4 x 6	765	912	6 x 8	1003	1188	8 x 16	1577	1867
2 x 6	658	785	4 x 7	832	988	6 x 9	1063	1260	8 x 17	1645	1945
2 x 7	722	862	4 x 8	883	1045	6 x 10	1125	1335	8 x 18	1697	2009
2 x 8	776	922	4 x 9	942	1116	6 x 11	1181	1400	8 x 19	1768	2089
2 x 9	836	990	4 x 10	1004	1192	6 x 12	1232	1458	8 x 20	1823	2152
2 x 10	902	1067	4 x 11	1063	1260	6 x 13	1303	1541			
2 x 11	954	1129	4 x 12	1117	1327	6 x 14	1351	1604	9 x 9	1233	1458
2 x 12	1010	1197	4 x 13	1183	1403	6 x 15	1410	1672	9 x 10	1297	1534
2 x 13	1077	1274	4 x 14	1233	1458	6 x 16	1478	1746	9 x 11	1351	1604
2 x 14	1129	1339	4 x 15	1293	1530	6 x 17	1532	1812	9 x 12	1407	1664
2 x 15	1170	1391	4 x 16	1358	1607	6 x 18	1585	1878	9 x 13	1478	1746
2 x 16	1252	1481	4 x 17	1410	1672	6 x 19	1649	1951	9 x 14	1525	1807
2 x 17	1304	1542	4 x 18	1469	1737	6 x 20	1703	2014	9 x 15	1585	1878
2 x 18	1360	1611	4 x 19	1533	1814				9 x 16	1645	1945
2 x 19	1423	1686	4 x 20	1589	1879	7 x 7	1015	1204	9 x 17	1703	2014
2 x 20	1481	1748				7 x 8	1067	1264	9 x 18	1755	2076
			5 x 5	752	899	7 x 9	1126	1336	9 x 19	1826	2160
3 x 3	542	645	5 x 6	821	976	7 x 10	1192	1407	9 x 20	1879	2219
3 x 4	595	708	5 x 7	884	1050	7 x 11	1244	1470			
3 x 5	646	774	5 x 8	935	1110	7 x 12	1299	1538	10 x 10	1359	1607
3 x 6	713	852	5 x 9	995	1181	7 x 13	1366	1617	10 x 11	1415	1672
3 x 7	778	924	5 x 10	1058	1253	7 x 14	1419	1676	10 x 12	1471	1739
3 x 8	836	990	5 x 11	1114	1325	7 x 15	1479	1747	10 x 13	1537	1819
3 x 9	892	1060	5 x 12	1172	1391	7 x 16	1540	1822	10 x 14	1588	1877
3 x 10	959	1132	5 x 13	1236	1466	7 x 17	1596	1890	10 x 15	1645	1945
3 x 11	1010	1197	5 x 14	1287	1526	7 x 18	1647	1948	10 x 16	1709	2021
3 x 12	1067	1264	5 x 15	1346	1595	7 x 19	1719	2030	10 x 17	1764	2088
3 x 13	1134	1340	5 x 16	1410	1672	7 x 20	1768	2089	10 x 18	1823	2152
3 x 14	1184	1404	5 x 17	1467	1736				10 x 19	1891	2231
3 x 15	1247	1473	5 x 18	1522	1802	8 x 8	1118	1324	10 x 20	1941	2293
3 x 16	1306	1544	5 x 19	1589	1879	8 x 9	1180	1395			
3 x 17	1360	1611	5 x 20	1637	1940	8 x 10	1229	1454			
3 x 18	1413	1676				8 x 11	1297	1534			
3 x 19	1486	1756				8 x 12	1350	1600			
3 x 20	1537	1815				8 x 13	1407	1664			

Kits Include:

- Mill Finish or Dk. Bronze
- Cut to size and mitered bodies
- Cut to size and mitered frames with covers
- Tension Clips
- Frame Braces for LED applications (Part #5357)
- All screws required to assemble by mechanical fastening
- All Corner Angles and/or Corner Keys required
- Packaging

Not Included in Kits:

- Face or Back
- Electrical Components
- Ballast Bracket(s) - See optional accessories
- Back Braces and Gussets
- Frame Support Tube - See optional accessories
- Raceway Covers and Cover Screws - See optional accessories
- Tension Tool - See optional accessories
- Mounting Provisions

Optional Accessories (pg 127):

- Ballast Bracket(s)
- Frame Support Tube
- Raceway Covers and Cover Screws
- Tension Tool

Kit Specifications:

- It is recommended to order kits 1" over nominal T12 or T8 lamp size to utilize .040 flat Aluminum Raceway Covers
- Custom size kits may be cut to any dimension
- Flexible Face Preparation - See page 129
- Frame Brace / Frame Support Tube placement - See page 130
- Tension Frame II is not engineered to integrate with the Divider System

Recommended Lamp Spacing:

- For illuminated backgrounds - 12" on center, using T12 or T8 lamps
- Always place lamps 3/4" from back of sign
- When using lamps, deduct \$6.01 per Frame Brace

Additional Information (pgs 196-197)

UL Recognized Component Systems
The Underwriters Laboratory file number is E136850

Note: It is recommended to use safety chains and prop-bars on all hingeable faces.

US Patent Numbers 6,061,941 / 6,637,080
CA Patent Numbers 2,245,623 / 2,387,222

Unassembled Double Face Kits w/ Reveal - For Flexible Faces

Medium Body w/ Tension Frame II and 1-1/2" Tension Frame Cover

Part #2015
KMB/86/84

Part #2086

Part #2084

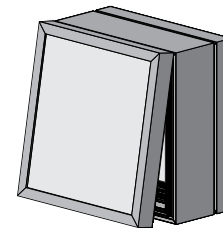
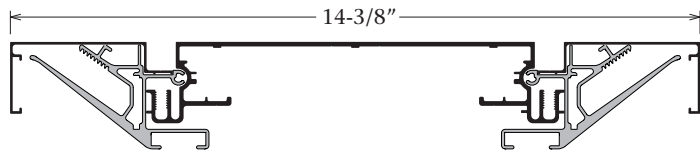

Size H'xW'	Mill Finish	Dk. Bronze	Size H'xW'	Mill Finish	Dk. Bronze	Size H'xW'	Mill Finish	Dk. Bronze	Size H'xW'	Mill Finish	Dk. Bronze
2 x 3	\$771	\$922	4 x 4	\$1066	\$1275	6 x 6	\$1410	\$1702	8 x 14	\$2326	\$2814
2 x 4	871	1039	4 x 5	1153	1382	6 x 7	1510	1821	8 x 15	2413	2921
2 x 5	958	1146	4 x 6	1239	1491	6 x 8	1598	1928	8 x 16	2509	3036
2 x 6	1042	1252	4 x 7	1336	1607	6 x 9	1683	2032	8 x 17	2598	3147
2 x 7	1142	1372	4 x 8	1423	1712	6 x 10	1782	2151	8 x 18	2682	3249
2 x 8	1227	1479	4 x 9	1510	1821	6 x 11	1869	2258	8 x 19	2781	3368
2 x 9	1315	1585	4 x 10	1608	1940	6 x 12	1954	2365	8 x 20	2869	3475
2 x 10	1413	1703	4 x 11	1693	2044	6 x 13	2053	2483	9 x 9	1954	2365
2 x 11	1500	1810	4 x 12	1782	2151	6 x 14	2140	2588	9 x 10	2053	2483
2 x 12	1588	1917	4 x 13	1881	2269	6 x 15	2228	2695	9 x 11	2140	2588
2 x 13	1683	2032	4 x 14	1966	2376	6 x 16	2326	2814	9 x 12	2227	2695
2 x 14	1771	2142	4 x 15	2053	2483	6 x 17	2413	2921	9 x 13	2326	2814
2 x 15	1859	2249	4 x 16	2151	2598	6 x 18	2497	3027	9 x 14	2413	2921
2 x 16	1957	2365	4 x 17	2237	2707	6 x 19	2598	3147	9 x 15	2497	3027
2 x 17	2045	2475	4 x 18	2326	2814	6 x 20	2682	3249	9 x 16	2598	3147
2 x 18	2130	2580	4 x 19	2425	2932	7 x 7	1608	1940	9 x 17	2682	3249
2 x 19	2228	2697	4 x 20	2509	3036	7 x 8	1692	2044	9 x 18	2770	3359
2 x 20	2317	2804				7 x 9	1782	2151	9 x 19	2869	3475
			5 x 5	1239	1491	7 x 10	1879	2269	9 x 20	2956	3582
3 x 3	871	1039	5 x 6	1324	1595	7 x 11	1966	2376	10 x 10	2149	2598
3 x 4	969	1160	5 x 7	1423	1714	7 x 12	2053	2483	10 x 11	2237	2707
3 x 5	1054	1265	5 x 8	1510	1821	7 x 13	2149	2598	10 x 12	2325	2814
3 x 6	1141	1371	5 x 9	1598	1928	7 x 14	2237	2707	10 x 13	2424	2931
3 x 7	1240	1491	5 x 10	1693	2044	7 x 15	2326	2814	10 x 14	2508	3036
3 x 8	1325	1596	5 x 11	1782	2151	7 x 16	2424	2932	10 x 15	2598	3145
3 x 9	1413	1702	5 x 12	1869	2258	7 x 17	2509	3036	10 x 16	2691	3259
3 x 10	1510	1821	5 x 13	1966	2376	7 x 18	2598	3147	10 x 17	2781	3367
3 x 11	1600	1928	5 x 14	2053	2483	7 x 19	2693	3260	10 x 18	2869	3475
3 x 12	1683	2032	5 x 15	2140	2588	7 x 20	2781	3368	10 x 19	2967	3593
3 x 13	1782	2151	5 x 16	2237	2707	8 x 8	1782	2151	10 x 20	3046	3692
3 x 14	1869	2258	5 x 17	2326	2814	8 x 9	1867	2258			
3 x 15	1957	2365	5 x 18	2413	2921	8 x 10	1966	2376			
3 x 16	2053	2485	5 x 19	2509	3038	8 x 11	2053	2483			
3 x 17	2140	2588	5 x 20	2598	3147	8 x 12	2140	2587			
3 x 18	2228	2695				8 x 13	2237	2707			
3 x 19	2326	2816									
3 x 20	2413	2921									

Kits Include:

- Mill Finish or Dk. Bronze
- Cut to size and mitered bodies
- Cut to size and mitered frames with covers
- Tension Clips
- Frame Braces for LED applications (Part #5352)
- All screws required to assemble by mechanical fastening
- All Corner Angles and/or Corner Keys required
- Packaging

Not Included in Kits:

- Faces
- Electrical Components
- Ballast Bracket(s) - See optional accessories
- Internal Supports
- Frame Support Tube - See optional accessories
- Raceway Covers and Cover Screws - See optional accessories
- Tension Tool - See optional accessories

Optional Accessories (pg 127):

- Ballast Bracket(s)
- Frame Support Tube
- Raceway Covers and Cover Screws
- Tension Tool

Kit Specifications:

- It is recommended to order kits 1" over nominal T12 or T8 lamp size to utilize .040 flat Aluminum Raceway Covers
- Custom size kits may be cut to any dimension
- Flexible Face Preparation - See page 129
- Frame Brace / Frame Support Tube placement - See page 130
- Tension Frame II is not engineered to integrate with the Divider System

Recommended Lamp Spacing:

- For illuminated backgrounds - 12" on center, using T12 or T8 lamps

Additional Information (pgs 196-197)

UL Recognized Component Systems
The Underwriters Laboratory file number is E136850

Note: It is recommended to use safety chains and prop-bars on all hingeable faces.

US Patent Numbers 6,061,941 / 6,637,080
CA Patent Numbers 2,245,623 / 2,387,222

Note: All dimensions are subject to the tolerance standards of the aluminum extrusion industry. Profile drawings are illustrative and rounded to the nearest 1/16".

CURRENT PRICE as of April 1, 2022



COMMERCIAL

Unassembled Double Face Kits w/ Reveal - For Flexible Faces

Wide Body w/ Tension Frame II and 1-1/2" Tension Frame Cover

Part #2005
KWB/86/84

Part #2086

Part #2084

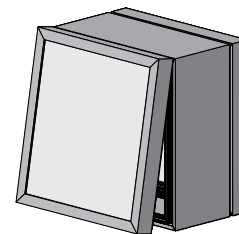
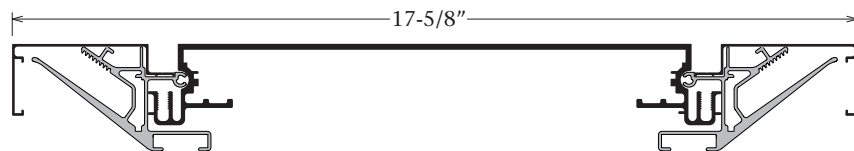

Size H'xW'	Mill Finish	Dk. Bronze	Size H'xW'	Mill Finish	Dk. Bronze	Size H'xW'	Mill Finish	Dk. Bronze	Size H'xW'	Mill Finish	Dk. Bronze
2 x 3	\$867	\$1061	4 x 4	\$1196	\$1469	6 x 6	\$1637	\$2014	8 x 14	\$2765	\$3396
2 x 4	978	1197	4 x 5	1296	1593	6 x 7	1772	2172	8 x 15	2863	3519
2 x 5	1077	1323	4 x 6	1418	1742	6 x 8	1870	2298	8 x 16	2970	3652
2 x 6	1197	1470	4 x 7	1550	1898	6 x 9	1968	2420	8 x 17	3098	3804
2 x 7	1334	1630	4 x 8	1649	2023	6 x 10	2103	2580	8 x 18	3193	3926
2 x 8	1431	1756	4 x 9	1748	2149	6 x 11	2202	2706	8 x 19	3327	4084
2 x 9	1529	1879	4 x 10	1882	2307	6 x 12	2301	2828	8 x 20	3426	4208
2 x 10	1663	2037	4 x 11	1980	2430	6 x 13	2435	2991	9 x 9	2301	2828
2 x 11	1762	2164	4 x 12	2077	2555	6 x 14	2532	3113	9 x 10	2433	2989
2 x 12	1862	2289	4 x 13	2214	2717	6 x 15	2631	3237	9 x 11	2532	3113
2 x 13	1993	2447	4 x 14	2311	2840	6 x 16	2765	3396	9 x 12	2631	3237
2 x 14	2093	2571	4 x 15	2412	2967	6 x 17	2863	3519	9 x 13	2765	3396
2 x 15	2194	2695	4 x 16	2540	3121	6 x 18	2961	3642	9 x 14	2863	3519
2 x 16	2325	2854	4 x 17	2642	3247	6 x 19	3098	3804	9 x 15	2961	3642
2 x 17	2426	2980	4 x 18	2741	3373	6 x 20	3193	3926	9 x 16	3098	3804
2 x 18	2523	3102	4 x 19	2873	3530	7 x 7	1907	2333	9 x 17	3193	3926
2 x 19	2656	3260	4 x 20	2970	3652	7 x 8	2004	2456	9 x 18	3293	4052
2 x 20	2756	3387				7 x 9	2103	2580	9 x 19	3426	4210
			5 x 5	1394	1718	7 x 10	2237	2740	9 x 20	3526	4335
3 x 3	978	1196	5 x 6	1514	1863	7 x 11	2335	2863	10 x 10	2564	3145
3 x 4	1088	1335	5 x 7	1649	2024	7 x 12	2433	2989	10 x 11	2663	3270
3 x 5	1186	1457	5 x 8	1748	2149	7 x 13	2564	3145	10 x 12	2763	3395
3 x 6	1308	1605	5 x 9	1847	2275	7 x 14	2663	3270	10 x 13	2896	3555
3 x 7	1442	1767	5 x 10	1980	2430	7 x 15	2765	3396	10 x 14	2995	3677
3 x 8	1541	1890	5 x 11	2077	2555	7 x 16	2898	3555	10 x 15	3096	3804
3 x 9	1637	2014	5 x 12	2176	2681	7 x 17	2995	3677	10 x 16	3225	3958
3 x 10	1772	2172	5 x 13	2311	2840	7 x 18	3098	3804	10 x 17	3327	4084
3 x 11	1870	2298	5 x 14	2412	2967	7 x 19	3226	3958	10 x 18	3426	4208
3 x 12	1968	2420	5 x 15	2508	3089	7 x 20	3327	4084	10 x 19	3559	4369
3 x 13	2103	2582	5 x 16	2642	3247	8 x 8	2103	2580	10 x 20	3675	4476
3 x 14	2202	2706	5 x 17	2741	3373	8 x 9	2202	2706			
3 x 15	2302	2830	5 x 18	2840	3496	8 x 10	2311	2840			
3 x 16	2435	2991	5 x 19	2971	3652	8 x 11	2433	2989			
3 x 17	2532	3113	5 x 20	3073	3779	8 x 12	2531	3113			
3 x 18	2631	3237				8 x 13	2642	3247			
3 x 19	2765	3396									
3 x 20	2864	3519									

Kits Include:

- Mill Finish or Dk. Bronze
- Cut to size and mitered bodies
- Cut to size and mitered frames with covers
- Tension Clips
- Frame Braces for LED applications (Part #5357)
- All screws required to assemble by mechanical fastening
- All Corner Angles and/or Corner Keys required
- Packaging

Not Included in Kits:

- Faces
- Electrical Components
- Ballast Bracket(s) - See optional accessories
- Internal Supports
- Frame Support Tube - See optional accessories
- Raceway Covers and Cover Screws - See optional accessories
- Tension Tool - See optional accessories

Optional Accessories (pg 127):

- Ballast Bracket(s)
- Frame Support Tube
- Raceway Covers and Cover Screws
- Tension Tool

Kit Specifications:

- It is recommended to order kits 1" over nominal T12 or T8 lamp size to utilize .040 flat Aluminum Raceway Covers
- Custom size kits may be cut to any dimension
- Flexible Face Preparation - See page 129
- Frame Brace / Frame Support Tube placement - See page 130
- Tension Frame II is not engineered to integrate with the Divider System

Recommended Lamp Spacing:

- For illuminated backgrounds - 12" on center, using T12 or T8 lamps
- When using lamps, deduct \$6.01 per Frame Brace

Additional Information (pgs 196-197)

UL Recognized Component Systems
The Underwriters Laboratory file number is E136850

Note: It is recommended to use safety chains and prop-bars on all hingeable faces.

US Patent Numbers 6,061,941 / 6,637,080
CA Patent Numbers 2,245,623 / 2,387,222

Unassembled Retro Kits w/ Reveal - For Flexible Faces

Retro Body w/ Tension Frame and Bleed Tension Frame Cover

Part #2040
K2040/85/95

Part #2085

Part #2095

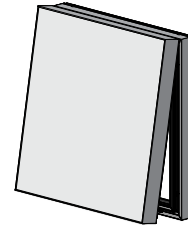
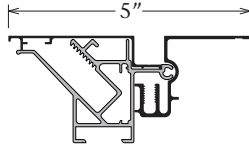

Size H'xW'	Mill Finish	Size H'xW'	Mill Finish	Size H'xW'	Mill Finish	Size H'xW'	Mill Finish
2 x 3	\$372	4 x 4	\$474	6 x 6	\$642	8 x 14	\$1043
2 x 4	404	4 x 5	511	6 x 7	690	8 x 15	1082
2 x 5	443	4 x 6	557	6 x 8	725	8 x 16	1117
2 x 6	490	4 x 7	611	6 x 9	762	8 x 17	1164
2 x 7	538	4 x 8	642	6 x 10	808	8 x 18	1201
2 x 8	569	4 x 9	685	6 x 11	849	8 x 19	1248
2 x 9	614	4 x 10	728	6 x 12	881	8 x 20	1284
2 x 10	657	4 x 11	762	6 x 13	930		
2 x 11	698	4 x 12	799	6 x 14	963	9 x 9	880
2 x 12	730	4 x 13	853	6 x 15	1002	9 x 10	924
2 x 13	778	4 x 14	881	6 x 16	1049	9 x 11	963
2 x 14	811	4 x 15	922	6 x 17	1083	9 x 12	997
2 x 15	855	4 x 16	967	6 x 18	1121	9 x 13	1049
2 x 16	897	4 x 17	1002	6 x 19	1170	9 x 14	1081
2 x 17	934	4 x 18	1041	6 x 20	1202	9 x 15	1121
2 x 18	969	4 x 19	1089			9 x 16	1165
2 x 19	1015	4 x 20	1121	7 x 7	737	9 x 17	1202
2 x 20	1053			7 x 8	769	9 x 18	1239
		5 x 5	546	7 x 9	809	9 x 19	1285
3 x 3	411	5 x 6	597	7 x 10	855	9 x 20	1320
3 x 4	444	5 x 7	643	7 x 11	891		
3 x 5	480	5 x 8	677	7 x 12	927	10 x 10	972
3 x 6	526	5 x 9	717	7 x 13	976	10 x 11	1006
3 x 7	574	5 x 10	762	7 x 14	1009	10 x 12	1043
3 x 8	611	5 x 11	797	7 x 15	1050	10 x 13	1090
3 x 9	648	5 x 12	840	7 x 16	1094	10 x 14	1122
3 x 10	698	5 x 13	881	7 x 17	1133	10 x 15	1164
3 x 11	732	5 x 14	918	7 x 18	1168	10 x 16	1209
3 x 12	767	5 x 15	956	7 x 19	1217	10 x 17	1247
3 x 13	815	5 x 16	1002	7 x 20	1252	10 x 18	1280
3 x 14	853	5 x 17	1038			10 x 19	1331
3 x 15	888	5 x 18	1077	8 x 8	804	10 x 20	1366
3 x 16	935	5 x 19	1122	8 x 9	843		
3 x 17	969	5 x 20	1157	8 x 10	876		
3 x 18	1009			8 x 11	924		
3 x 19	1054			8 x 12	962		
3 x 20	1094			8 x 13	997		

Kits Include:

- Mill Finish
- Cut to size and mitered bodies
- Cut to size and mitered frames with covers
- Tension Clips
- Frame Braces for LED applications (Part #5357)
- All screws required to assemble by mechanical fastening
- All Corner Angles and/or Corner Keys required
- Packaging
- Prices reflect one (1) Retro Body kit, SINGLE FACE APPLICATION

Not Included in Kits:

- Face
- Electrical Components
- Frame Support Tube - See optional accessories
- Tension Tool - See optional accessories
- Mounting Provisions

Optional Accessories (pg 127):

- Frame Support Tube
- Tension Tool

Kit Specifications:

- Kits will be cut .265" larger to fit over existing structure
- Custom size kits may be cut to any dimension
- Flexible Face Preparation - See page 129
- Frame Brace / Frame Support Tube placement - See page 130
- Illumination may vary depending on application
- Tension Frame is not engineered to integrate with the Divider System

Additional Information (pgs 196-197)

Note: All dimensions are subject to the tolerance standards of the aluminum extrusion industry. Profile drawings are illustrative and rounded to the nearest 1/16".

CURRENT PRICE as of April 1, 2022



COMMERCIAL

Unassembled Single Face Kits w/ Reveal - For Flexible Faces

Slimline Single Face Body w/ Tension Frame and Bleed Tension Frame Cover

Part #2020
K2020/85/95

Part #2085

Part #2095

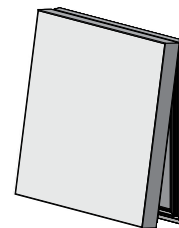
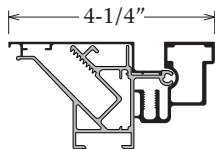

Size H'xW'	Mill Finish	Dk. Bronze	Size H'xW'	Mill Finish	Dk. Bronze	Size H'xW'	Mill Finish	Dk. Bronze	Size H'xW'	Mill Finish	Dk. Bronze
2 x 3	\$385	\$459	4 x 4	\$495	\$590	6 x 6	\$651	\$769	8 x 14	\$1030	\$1213
2 x 4	419	499	4 x 5	535	637	6 x 7	689	812	8 x 15	1070	1263
2 x 5	462	546	4 x 6	571	678	6 x 8	725	859	8 x 16	1110	1299
2 x 6	500	592	4 x 7	615	724	6 x 9	765	903	8 x 17	1146	1346
2 x 7	538	639	4 x 8	651	769	6 x 10	804	950	8 x 18	1188	1394
2 x 8	571	678	4 x 9	694	816	6 x 11	845	991	8 x 19	1223	1438
2 x 9	618	725	4 x 10	728	860	6 x 12	881	1039	8 x 20	1263	1481
2 x 10	653	771	4 x 11	765	903	6 x 13	918	1083	9 x 9	880	1038
2 x 11	694	816	4 x 12	807	950	6 x 14	956	1125	9 x 10	915	1077
2 x 12	730	862	4 x 13	851	998	6 x 15	998	1176	9 x 11	956	1125
2 x 13	769	911	4 x 14	881	1039	6 x 16	1035	1217	9 x 12	992	1168
2 x 14	807	950	4 x 15	923	1086	6 x 17	1071	1265	9 x 13	1035	1217
2 x 15	852	1002	4 x 16	960	1130	6 x 18	1113	1309	9 x 14	1069	1260
2 x 16	885	1041	4 x 17	998	1176	6 x 19	1153	1354	9 x 15	1113	1309
2 x 17	923	1086	4 x 18	1039	1220	6 x 20	1189	1395	9 x 16	1148	1348
2 x 18	962	1132	4 x 19	1079	1267	7 x 7	725	859	9 x 17	1189	1395
2 x 19	1002	1177	4 x 20	1113	1309	7 x 8	760	897	9 x 18	1225	1441
2 x 20	1039	1220				7 x 9	805	948	9 x 19	1264	1483
			5 x 5	571	678	7 x 10	839	990	9 x 20	1300	1530
3 x 3	425	507	5 x 6	613	722	7 x 11	880	1038	10 x 10	953	1121
3 x 4	463	547	5 x 7	653	771	7 x 12	916	1079	10 x 11	990	1164
3 x 5	502	594	5 x 8	689	812	7 x 13	958	1129	10 x 12	1030	1213
3 x 6	538	639	5 x 9	730	862	7 x 14	992	1168	10 x 13	1067	1252
3 x 7	576	683	5 x 10	765	903	7 x 15	1037	1218	10 x 14	1104	1296
3 x 8	615	724	5 x 11	805	948	7 x 16	1070	1263	10 x 15	1146	1346
3 x 9	657	776	5 x 12	849	994	7 x 17	1113	1309	10 x 16	1183	1388
3 x 10	694	816	5 x 13	881	1039	7 x 18	1150	1351	10 x 17	1221	1434
3 x 11	732	863	5 x 14	918	1083	7 x 19	1190	1397	10 x 18	1257	1479
3 x 12	769	911	5 x 15	960	1130	7 x 20	1225	1441	10 x 19	1299	1529
3 x 13	809	954	5 x 16	998	1176	8 x 8	799	942	10 x 20	1339	1564
3 x 14	851	998	5 x 17	1037	1218	8 x 9	839	990			
3 x 15	888	1045	5 x 18	1079	1267	8 x 10	876	1030			
3 x 16	924	1088	5 x 19	1114	1311	8 x 11	915	1077			
3 x 17	962	1132	5 x 20	1150	1351	8 x 12	954	1122			
3 x 18	1004	1180				8 x 13	992	1168			
3 x 19	1041	1221									
3 x 20	1083	1268									

Kits Include:

- Mill Finish or Dk. Bronze
- Cut to size and mitered bodies
- Cut to size and mitered frames with covers
- Tension Clips
- Frame Braces (Part #5352)
- All screws required to assemble by mechanical fastening
- All Corner Angles and/or Corner Keys required
- Packaging

Not Included in Kits:

- Face or Back
- Electrical Components
- Back Braces and Gussets
- Frame Support Tube - See optional accessories
- Tension Tool - See optional accessories
- Mounting Provisions

Optional Accessories (pg 127):

- Frame Support Tube
- Tension Tool

Kit Specifications:

- Recommended for LED applications
- Custom size kits may be cut to any dimension
- Flexible Face Preparation - See page 129
- Frame Brace / Frame Support Tube placement - See page 130
- Tension Frame is not engineered to integrate with the Divider System

Additional Information (pgs 196-197)

UL Recognized Component Systems
The Underwriters Laboratory file number is E136850

Note: It is recommended to use safety chains and prop-bars on all hingeable faces.

US Patent Numbers 6,061,941 / 6,637,080
CA Patent Numbers 2,245,623 / 2,387,222

Unassembled Single Face Kits w/ Reveal - For Flexible Faces

Narrow Single Face Body w/ Tension Frame and Bleed Tension Frame Cover

Part #2021
K2021/85/95

Part #2085

Part #2095

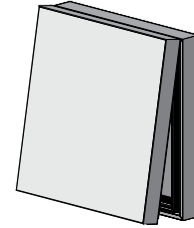
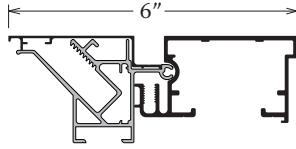

Size H'xW'	Mill Finish	Dk. Bronze	Size H'xW'	Mill Finish	Dk. Bronze	Size H'xW'	Mill Finish	Dk. Bronze	Size H'xW'	Mill Finish	Dk. Bronze
2 x 3	\$415	\$499	4 x 4	\$542	\$654	6 x 6	\$721	\$867	8 x 14	\$1160	\$1394
2 x 4	456	548	4 x 5	587	708	6 x 7	765	918	8 x 15	1207	1450
2 x 5	502	602	4 x 6	630	761	6 x 8	808	975	8 x 16	1251	1495
2 x 6	547	657	4 x 7	681	813	6 x 9	853	1026	8 x 17	1295	1550
2 x 7	591	710	4 x 8	721	867	6 x 10	897	1081	8 x 18	1342	1607
2 x 8	630	761	4 x 9	771	922	6 x 11	944	1130	8 x 19	1382	1657
2 x 9	683	816	4 x 10	809	976	6 x 12	987	1188	8 x 20	1427	1709
2 x 10	722	869	4 x 11	853	1026	6 x 13	1030	1239			
2 x 11	771	922	4 x 12	900	1081	6 x 14	1073	1288	9 x 9	985	1186
2 x 12	812	978	4 x 13	950	1136	6 x 15	1120	1347	9 x 10	1027	1233
2 x 13	857	1034	4 x 14	987	1188	6 x 16	1164	1397	9 x 11	1073	1288
2 x 14	900	1081	4 x 15	1035	1241	6 x 17	1208	1453	9 x 12	1116	1340
2 x 15	951	1138	4 x 16	1079	1293	6 x 18	1253	1504	9 x 13	1164	1397
2 x 16	991	1189	4 x 17	1120	1347	6 x 19	1300	1558	9 x 14	1205	1449
2 x 17	1035	1241	4 x 18	1168	1400	6 x 20	1343	1608	9 x 15	1253	1504
2 x 18	1081	1295	4 x 19	1213	1454				9 x 16	1296	1554
2 x 19	1122	1348	4 x 20	1253	1504	7 x 7	808	975	9 x 17	1343	1608
2 x 20	1168	1400				7 x 8	849	1019	9 x 18	1387	1661
			5 x 5	630	761	7 x 9	899	1079	9 x 19	1430	1712
3 x 3	462	555	5 x 6	677	812	7 x 10	938	1129	9 x 20	1473	1768
3 x 4	503	603	5 x 7	722	869	7 x 11	985	1186			
3 x 5	548	658	5 x 8	765	918	7 x 12	1029	1235	10 x 10	1070	1285
3 x 6	591	710	5 x 9	812	978	7 x 13	1076	1291	10 x 11	1113	1335
3 x 7	637	767	5 x 10	853	1026	7 x 14	1116	1340	10 x 12	1160	1394
3 x 8	681	813	5 x 11	899	1079	7 x 15	1165	1398	10 x 13	1202	1441
3 x 9	728	874	5 x 12	948	1133	7 x 16	1207	1450	10 x 14	1244	1493
3 x 10	771	922	5 x 13	987	1188	7 x 17	1253	1504	10 x 15	1295	1550
3 x 11	813	979	5 x 14	1030	1239	7 x 18	1299	1557	10 x 16	1336	1601
3 x 12	857	1034	5 x 15	1079	1293	7 x 19	1344	1609	10 x 17	1381	1655
3 x 13	903	1085	5 x 16	1120	1347	7 x 20	1387	1661	10 x 18	1423	1708
3 x 14	950	1136	5 x 17	1165	1398				10 x 19	1471	1767
3 x 15	994	1193	5 x 18	1213	1454	8 x 8	891	1071	10 x 20	1516	1810
3 x 16	1037	1243	5 x 19	1255	1505	8 x 9	938	1129			
3 x 17	1081	1295	5 x 20	1299	1557	8 x 10	982	1177			
3 x 18	1128	1350				8 x 11	1027	1233			
3 x 19	1170	1402				8 x 12	1071	1287			
3 x 20	1218	1455				8 x 13	1116	1340			

Kits Include:

- Mill Finish or Dk. Bronze
- Cut to size and mitered bodies
- Cut to size and mitered frames with covers
- Tension Clips
- Frame Braces (Part #5350)
- All screws required to assemble by mechanical fastening
- All Corner Angles and/or Corner Keys required
- Packaging

Not Included in Kits:

- Face or Back
- Electrical Components
- Back Braces and Gussets
- Frame Support Tube - See optional accessories
- Tension Tool - See optional accessories
- 6" Radius Corners - See optional accessories
- Mounting Provisions

Optional Accessories (pgs 127-128):

- Frame Support Tube
- Tension Tool
- 6" Radius Corners

Kit Specifications:

- **Recommended for LED applications**
- Custom size kits may be cut to any dimension
- Flexible Face Preparation - See page 129
- Frame Brace / Frame Support Tube placement - See page 130
- Tension Frame is not engineered to integrate with the Divider System

Additional Information (pgs 196-197)

Note: All dimensions are subject to the tolerance standards of the aluminum extrusion industry. Profile drawings are illustrative and rounded to the nearest 1/16".

CURRENT PRICE as of April 1, 2022



COMMERCIAL

Unassembled Single Face Kits w/ Reveal - For Flexible Faces

Single Face Body w/ Tension Frame and Bleed Tension Frame Cover

Part #2025
KSF/85/95

Part #2085

Part #2095

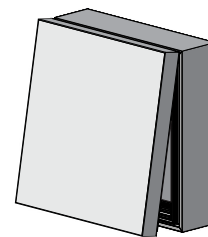
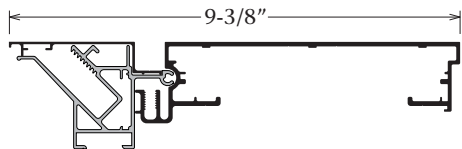

Size H'xW'	Mill Finish	Dk. Bronze	Size H'xW'	Mill Finish	Dk. Bronze	Size H'xW'	Mill Finish	Dk. Bronze	Size H'xW'	Mill Finish	Dk. Bronze
2 x 3	\$431	\$520	4 x 4	\$567	\$689	6 x 6	\$781	\$942	8 x 14	\$1299	\$1558
2 x 4	474	574	4 x 5	615	748	6 x 7	841	1011	8 x 15	1348	1620
2 x 5	523	631	4 x 6	674	815	6 x 8	888	1070	8 x 16	1397	1669
2 x 6	583	704	4 x 7	738	884	6 x 9	936	1126	8 x 17	1454	1740
2 x 7	642	774	4 x 8	781	942	6 x 10	995	1196	8 x 18	1504	1800
2 x 8	686	827	4 x 9	835	1002	6 x 11	1046	1251	8 x 19	1562	1869
2 x 9	742	885	4 x 10	890	1071	6 x 12	1090	1312	8 x 20	1609	1926
2 x 10	796	958	4 x 11	936	1126	6 x 13	1149	1379			
2 x 11	847	1014	4 x 12	987	1184	6 x 14	1196	1434	9 x 9	1089	1311
2 x 12	892	1073	4 x 13	1051	1257	6 x 15	1247	1498	9 x 10	1146	1374
2 x 13	953	1145	4 x 14	1090	1312	6 x 16	1304	1562	9 x 11	1196	1434
2 x 14	998	1196	4 x 15	1142	1371	6 x 17	1350	1623	9 x 12	1241	1489
2 x 15	1053	1260	4 x 16	1201	1438	6 x 18	1400	1679	9 x 13	1304	1562
2 x 16	1106	1325	4 x 17	1247	1498	6 x 19	1461	1747	9 x 14	1347	1618
2 x 17	1153	1382	4 x 18	1297	1554	6 x 20	1505	1802	9 x 15	1400	1679
2 x 18	1202	1439	4 x 19	1358	1624				9 x 16	1455	1743
2 x 19	1260	1511	4 x 20	1400	1679	7 x 7	900	1082	9 x 17	1505	1802
2 x 20	1309	1565				7 x 8	944	1132	9 x 18	1553	1861
			5 x 5	662	804	7 x 9	997	1195	9 x 19	1612	1929
3 x 3	480	581	5 x 6	722	871	7 x 10	1051	1260	9 x 20	1657	1988
3 x 4	524	633	5 x 7	783	944	7 x 11	1101	1323			
3 x 5	574	693	5 x 8	828	998	7 x 12	1148	1375	10 x 10	1205	1442
3 x 6	630	762	5 x 9	880	1060	7 x 13	1209	1449	10 x 11	1249	1497
3 x 7	690	831	5 x 10	936	1126	7 x 14	1253	1501	10 x 12	1299	1558
3 x 8	738	884	5 x 11	985	1183	7 x 15	1306	1564	10 x 13	1358	1621
3 x 9	789	948	5 x 12	1038	1243	7 x 16	1360	1632	10 x 14	1403	1679
3 x 10	847	1014	5 x 13	1090	1312	7 x 17	1411	1691	10 x 15	1454	1740
3 x 11	895	1074	5 x 14	1137	1367	7 x 18	1458	1746	10 x 16	1513	1807
3 x 12	942	1133	5 x 15	1189	1426	7 x 19	1520	1816	10 x 17	1561	1866
3 x 13	1002	1202	5 x 16	1247	1498	7 x 20	1565	1874	10 x 18	1605	1925
3 x 14	1051	1257	5 x 17	1295	1553				10 x 19	1668	1998
3 x 15	1100	1318	5 x 18	1346	1612	8 x 8	990	1189	10 x 20	1715	2047
3 x 16	1156	1384	5 x 19	1402	1680	8 x 9	1039	1249			
3 x 17	1202	1439	5 x 20	1447	1734	8 x 10	1086	1302			
3 x 18	1252	1501				8 x 11	1146	1374			
3 x 19	1311	1568				8 x 12	1195	1432			
3 x 20	1362	1625				8 x 13	1241	1489			

Kits Include:

- Mill Finish or Dk. Bronze
- Cut to size and mitered bodies
- Cut to size and mitered frames with covers
- Tension Clips
- Frame Braces for LED applications (Part #5357)
- All screws required to assemble by mechanical fastening
- All Corner Angles and/or Corner Keys required
- Packaging

Not Included in Kits:

- Face or Back
- Electrical Components
- Ballast Bracket(s) - See optional accessories
- Back Braces and Gussets
- Frame Support Tube - See optional accessories
- Raceway Covers and Cover Screws- See optional accessories
- Tension Tool - See optional accessories
- 6" and 9" Radius Corners - See optional accessories
- Mounting Provisions

Optional Accessories (pgs 127-128):

- Ballast Bracket(s)
- Frame Support Tube
- Raceway Covers and Cover Screws
- Tension Tool
- 6" and 9" Radius Corners

Kit Specifications:

- It is recommended to order kits 1" over nominal T12 or T8 lamp size to utilize .040 flat Aluminum Raceway Covers
- Custom size kits may be cut to any dimension
- Flexible Face Preparation - See page 129
- Frame Brace / Frame Support Tube placement - See page 130

Recommended Lamp Spacing:

- For illuminated backgrounds - 12" on center, using T12 or T8 lamps
- Always place lamps 3/4" from back of sign
- When using lamps, deduct \$6.01 per Frame Brace

Additional Information (pgs 196-197)



Note: It is recommended to use safety chains and prop-bars on all hingeable faces.

US Patent Numbers 6,061,941 / 6,637,080
CA Patent Numbers 2,245,623 / 2,387,222

Unassembled Double Face Kits w/ Reveal - For Flexible Faces

Medium Body w/ Tension Frame and Bleed Tension Frame Cover

Part #2015
KMB/85/95

Part #2085

Part #2095

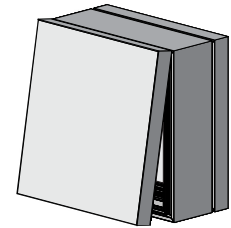
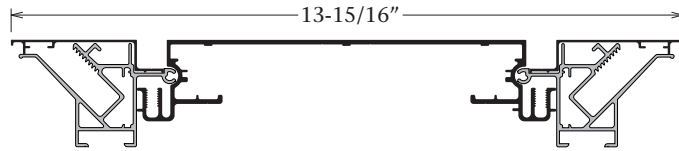

Size H'xW'	Mill Finish	Dk. Bronze	Size H'xW'	Mill Finish	Dk. Bronze	Size H'xW'	Mill Finish	Dk. Bronze	Size H'xW'	Mill Finish	Dk. Bronze
2 x 3	\$705	\$853	4 x 4	\$938	\$1133	6 x 6	\$1311	\$1572	8 x 14	\$2195	\$2623
2 x 4	778	943	4 x 5	1019	1235	6 x 7	1413	1693	8 x 15	2282	2730
2 x 5	860	1039	4 x 6	1126	1356	6 x 8	1488	1783	8 x 16	2356	2819
2 x 6	964	1164	4 x 7	1228	1477	6 x 9	1573	1891	8 x 17	2463	2940
2 x 7	1069	1284	4 x 8	1308	1569	6 x 10	1675	2002	8 x 18	2542	3039
2 x 8	1148	1375	4 x 9	1393	1672	6 x 11	1754	2097	8 x 19	2646	3161
2 x 9	1233	1482	4 x 10	1489	1786	6 x 12	1835	2199	8 x 20	2725	3253
2 x 10	1334	1595	4 x 11	1572	1889	6 x 13	1940	2321	9 x 9	1837	2202
2 x 11	1413	1693	4 x 12	1655	1984	6 x 14	2017	2416	9 x 10	1935	2314
2 x 12	1494	1790	4 x 13	1758	2108	6 x 15	2105	2517	9 x 11	2018	2417
2 x 13	1598	1916	4 x 14	1834	2198	6 x 16	2199	2628	9 x 12	2097	2509
2 x 14	1675	2002	4 x 15	1923	2305	6 x 17	2286	2731	9 x 13	2200	2634
2 x 15	1760	2109	4 x 16	2018	2417	6 x 18	2365	2829	9 x 14	2278	2729
2 x 16	1859	2222	4 x 17	2104	2511	6 x 19	2470	2948	9 x 15	2366	2830
2 x 17	1940	2321	4 x 18	2180	2614	6 x 20	2548	3043	9 x 16	2464	2945
2 x 18	2020	2419	4 x 19	2287	2733	7 x 7	1517	1814	9 x 17	2549	3044
2 x 19	2128	2540	4 x 20	2361	2826	7 x 8	1593	1902	9 x 18	2627	3142
2 x 20	2199	2628				7 x 9	1680	2008	9 x 19	2731	3265
			5 x 5	1102	1332	7 x 10	1776	2121	9 x 20	2808	3356
3 x 3	789	953	5 x 6	1204	1451	7 x 11	1858	2221	10 x 10	2033	2426
3 x 4	862	1041	5 x 7	1312	1573	7 x 12	1940	2321	10 x 11	2111	2526
3 x 5	947	1144	5 x 8	1386	1668	7 x 13	2044	2442	10 x 12	2196	2626
3 x 6	1050	1265	5 x 9	1471	1768	7 x 14	2115	2531	10 x 13	2301	2745
3 x 7	1156	1387	5 x 10	1570	1883	7 x 15	2203	2638	10 x 14	2378	2833
3 x 8	1229	1478	5 x 11	1651	1980	7 x 16	2307	2754	10 x 15	2463	2940
3 x 9	1319	1584	5 x 12	1732	2083	7 x 17	2386	2852	10 x 16	2563	3058
3 x 10	1416	1696	5 x 13	1837	2202	7 x 18	2467	2947	10 x 17	2643	3157
3 x 11	1495	1791	5 x 14	1911	2291	7 x 19	2574	3073	10 x 18	2725	3253
3 x 12	1577	1894	5 x 15	1998	2398	7 x 20	2646	3161	10 x 19	2829	3377
3 x 13	1684	2018	5 x 16	2097	2509	8 x 8	1667	1993	10 x 20	2905	3466
3 x 14	1758	2108	5 x 17	2176	2611	8 x 9	1754	2097			
3 x 15	1846	2211	5 x 18	2262	2707	8 x 10	1826	2191			
3 x 16	1946	2328	5 x 19	2366	2830	8 x 11	1933	2313			
3 x 17	2024	2424	5 x 20	2440	2920	8 x 12	2016	2413			
3 x 18	2107	2524				8 x 13	2092	2507			
3 x 19	2211	2646									
3 x 20	2287	2733									

Kits Include:

- Mill Finish or Dk. Bronze
- Cut to size and mitered bodies
- Cut to size and mitered frames with covers
- Tension Clips
- Frame Braces for LED applications (Part #5357)
- All screws required to assemble by mechanical fastening
- All Corner Angles and/or Corner Keys required
- Packaging

Not Included in Kits:

- Faces
- Electrical Components
- Ballast Bracket(s) - See optional accessories
- Internal Supports
- Frame Support Tube - See optional accessories
- Raceway Covers and Cover Screws- See optional accessories
- Tension Tool - See optional accessories
- 6" and 9" Radius Corners - See optional accessories

Optional Accessories (pgs 127-128):

- Ballast Bracket(s)
- Frame Support Tube
- Raceway Covers and Cover Screws
- Tension Tool
- 6" and 9" Radius Corners

Kit Specifications:

- It is recommended to order kits 1" over nominal T12 or T8 lamp size to utilize .040 flat Aluminum Raceway Covers
- Custom size kits may be cut to any dimension
- Flexible Face Preparation - See page 129
- Frame Brace / Frame Support Tube placement - See page 130
- Tension Frame is not engineered to integrate with the Divider System

Recommended Lamp Spacing:

- For illuminated backgrounds - 12" on center, using T12 or T8 lamps
- When using lamps, deduct \$6.01 per Frame Brace

Additional Information (pgs 196-197)

Note: All dimensions are subject to the tolerance standards of the aluminum extrusion industry. Profile drawings are illustrative and rounded to the nearest 1/16".

CURRENT PRICE as of April 1, 2022



COMMERCIAL

Unassembled Double Face Kits w/ Reveal - For Flexible Faces

Wide Body w/ Tension Frame and Bleed Tension Frame Cover

Part #2005
KWB/85/95

Part #2085

Part #2095

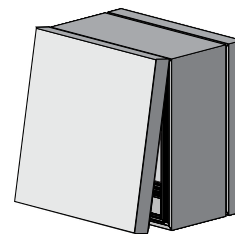
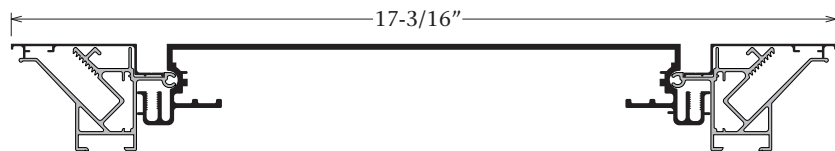

Size H'xW'	Mill Finish	Dk. Bronze	Size H'xW'	Mill Finish	Dk. Bronze	Size H'xW'	Mill Finish	Dk. Bronze	Size H'xW'	Mill Finish	Dk. Bronze
2 x 3	\$792	\$956	4 x 4	\$1067	\$1290	6 x 6	\$1493	\$1790	8 x 14	\$2516	\$3011
2 x 4	881	1066	4 x 5	1162	1404	6 x 7	1609	1933	8 x 15	2618	3137
2 x 5	975	1176	4 x 6	1283	1544	6 x 8	1696	2036	8 x 16	2706	3244
2 x 6	1092	1315	4 x 7	1398	1679	6 x 9	1800	2164	8 x 17	2826	3380
2 x 7	1212	1457	4 x 8	1486	1787	6 x 10	1911	2291	8 x 18	2917	3494
2 x 8	1302	1568	4 x 9	1588	1913	6 x 11	2008	2410	8 x 19	3039	3636
2 x 9	1403	1688	4 x 10	1702	2039	6 x 12	2100	2521	8 x 20	3129	3743
2 x 10	1516	1814	4 x 11	1798	2160	6 x 13	2222	2662	9 x 9	2105	2523
2 x 11	1609	1933	4 x 12	1891	2273	6 x 14	2310	2766	9 x 10	2216	2659
2 x 12	1707	2044	4 x 13	2012	2413	6 x 15	2413	2891	9 x 11	2311	2770
2 x 13	1825	2188	4 x 14	2097	2517	6 x 16	2524	3020	9 x 12	2404	2888
2 x 14	1911	2291	4 x 15	2202	2640	6 x 17	2619	3138	9 x 13	2526	3024
2 x 15	2017	2416	4 x 16	2313	2772	6 x 18	2712	3252	9 x 14	2614	3135
2 x 16	2124	2544	4 x 17	2408	2889	6 x 19	2833	3389	9 x 15	2714	3253
2 x 17	2222	2662	4 x 18	2504	3002	6 x 20	2919	3499	9 x 16	2830	3387
2 x 18	2314	2777	4 x 19	2622	3140	7 x 7	1731	2068	9 x 17	2921	3502
2 x 19	2436	2915	4 x 20	2710	3249	7 x 8	1815	2174	9 x 18	3018	3617
2 x 20	2526	3024				7 x 9	1921	2303	9 x 19	3137	3755
			5 x 5	1259	1520	7 x 10	2030	2426	9 x 20	3226	3859
3 x 3	888	1076	5 x 6	1374	1653	7 x 11	2124	2544	10 x 10	2328	2785
3 x 4	981	1184	5 x 7	1494	1798	7 x 12	2219	2661	10 x 11	2421	2896
3 x 5	1073	1297	5 x 8	1580	1902	7 x 13	2338	2800	10 x 12	2517	3014
3 x 6	1192	1434	5 x 9	1684	2024	7 x 14	2425	2907	10 x 13	2638	3152
3 x 7	1314	1577	5 x 10	1795	2155	7 x 15	2527	3026	10 x 14	2726	3260
3 x 8	1400	1684	5 x 11	1890	2269	7 x 16	2643	3162	10 x 15	2829	3384
3 x 9	1501	1807	5 x 12	1985	2386	7 x 17	2737	3276	10 x 16	2939	3514
3 x 10	1616	1938	5 x 13	2105	2523	7 x 18	2832	3388	10 x 17	3036	3631
3 x 11	1709	2053	5 x 14	2194	2635	7 x 19	2951	3527	10 x 18	3130	3744
3 x 12	1804	2168	5 x 15	2293	2754	7 x 20	3039	3636	10 x 19	3250	3883
3 x 13	1925	2306	5 x 16	2404	2888	8 x 8	1905	2282	10 x 20	3336	3993
3 x 14	2012	2413	5 x 17	2504	3002	8 x 9	2007	2402			
3 x 15	2114	2536	5 x 18	2598	3117	8 x 10	2095	2512			
3 x 16	2228	2665	5 x 19	2714	3253	8 x 11	2212	2650			
3 x 17	2318	2781	5 x 20	2806	3361	8 x 12	2310	2766			
3 x 18	2414	2892				8 x 13	2401	2884			
3 x 19	2532	3035									
3 x 20	2624	3142									

Kits Include:

- Mill Finish or Dk. Bronze
- Cut to size and mitered bodies
- Cut to size and mitered frames with covers
- Tension Clips
- Frame Braces for LED applications (Part #5357)
- All screws required to assemble by mechanical fastening
- All Corner Angles and/or Corner Keys required
- Packaging

Not Included in Kits:

- Faces
- Electrical Components
- Ballast Bracket(s) - See optional accessories
- Internal Supports
- Frame Support Tube - See optional accessories
- Raceway Covers and Cover Screws- See optional accessories
- Tension Tool - See optional accessories
- 6" and 9" Radius Corners - See optional accessories

Optional Accessories (pgs 127-128):

- Ballast Bracket(s)
- Frame Support Tube
- Raceway Covers and Cover Screws
- Tension Tool
- 6" and 9" Radius Corners

Kit Specifications:

- It is recommended to order kits 1" over nominal T12 or T8 lamp size to utilize .040 flat Aluminum Raceway Covers
- Custom size kits may be cut to any dimension
- Flexible Face Preparation - See page 129
- Frame Brace / Frame Support Tube placement - See page 130
- Tension Frame is not engineered to integrate with the Divider System

Recommended Lamp Spacing:

- For illuminated backgrounds - 12" on center, using T12 or T8 lamps
- When using lamps, deduct \$6.01 per Frame Brace

Additional Information (pgs 196-197)

UL Recognized Component Systems
The Underwriters Laboratory file number is E136850

Note: It is recommended to use safety chains and prop-bars on all hingeable faces.

US Patent Numbers 6,061,941 / 6,637,080
CA Patent Numbers 2,245,623 / 2,387,222

Unassembled Retro Kits w/ Reveal - For Flexible Faces

Retro Body w/ Tension Frame and 1-1/2" Tension Frame Cover

Part #2040
K2040/85/84

Part #2085

Part #2084

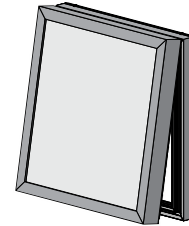
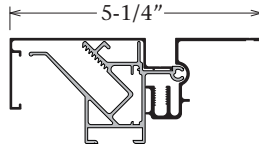

Size H'xW'	Mill Finish	Size H'xW'	Mill Finish	Size H'xW'	Mill Finish	Size H'xW'	Mill Finish
2 x 3	\$388	4 x 4	\$495	6 x 6	\$6673	8 x 14	\$1101
2 x 4	424	4 x 5	536	6 x 7	729	8 x 15	1141
2 x 5	463	4 x 6	586	6 x 8	761	8 x 16	1176
2 x 6	511	4 x 7	639	6 x 9	805	8 x 17	1227
2 x 7	562	4 x 8	673	6 x 10	849	8 x 18	1264
2 x 8	597	4 x 9	717	6 x 11	891	8 x 19	1316
2 x 9	642	4 x 10	762	6 x 12	924	8 x 20	1356
2 x 10	690	4 x 11	805	6 x 13	981		
2 x 11	730	4 x 12	841	6 x 14	1013	9 x 9	927
2 x 12	767	4 x 13	892	6 x 15	1055	9 x 10	975
2 x 13	820	4 x 14	927	6 x 16	1106	9 x 11	1013
2 x 14	853	4 x 15	970	6 x 17	1145	9 x 12	1053
2 x 15	895	4 x 16	1019	6 x 18	1181	9 x 13	1106
2 x 16	944	4 x 17	1055	6 x 19	1229	9 x 14	1137
2 x 17	982	4 x 18	1098	6 x 20	1268	9 x 15	1181
2 x 18	1021	4 x 19	1148			9 x 16	1227
2 x 19	1070	4 x 20	1184	7 x 7	774	9 x 17	1268
2 x 20	1110			7 x 8	809	9 x 18	1303
		5 x 5	574	7 x 9	851	9 x 19	1359
		5 x 6	627	7 x 10	900	9 x 20	1395
		5 x 7	674	7 x 11	938		
		5 x 8	710	7 x 12	976	10 x 10	1021
		5 x 9	752	7 x 13	1027	10 x 11	1060
		5 x 10	801	7 x 14	1065	10 x 12	1101
		5 x 11	839	7 x 15	1109	10 x 13	1149
		5 x 12	881	7 x 16	1152	10 x 14	1186
		5 x 13	928	7 x 17	1193	10 x 15	1227
		5 x 14	964	7 x 18	1228	10 x 16	1274
		5 x 15	1007	7 x 19	1283	10 x 17	1315
		5 x 16	1055	7 x 20	1316	10 x 18	1356
		5 x 17	1097			10 x 19	1407
		5 x 18	1136	8 x 8	845	10 x 20	1439
		5 x 19	1184	8 x 9	888		
		5 x 20	1218	8 x 10	923		
				8 x 11	975		
				8 x 12	1011		
				8 x 13	1053		

Kits Include:

- Mill Finish
- Cut to size and mitered bodies
- Cut to size and mitered frames with covers
- Tension Clips
- Frame Braces for LED applications (Part #5357)
- All screws required to assemble by mechanical fastening
- All Corner Angles and/or Corner Keys required
- Packaging
- Prices reflect one (1) Retro Body kit, SINGLE FACE APPLICATION

Not Included in Kits:

- Face
- Electrical Components
- Frame Support Tube - See optional accessories
- Tension Tool - See optional accessories
- Mounting Provisions

Optional Accessories (pg 127):

- Frame Support Tube
- Tension Tool

Kit Specifications:

- Kits will be cut .265" larger to fit over existing structure
- Custom size kits may be cut to any dimension
- Flexible Face Preparation - See page 129
- Frame Brace / Frame Support Tube placement - See page 130
- Illumination may vary depending on application
- Tension Frame is not engineered to integrate with the Divider System

Additional Information (pgs 196-197)

Note: All dimensions are subject to the tolerance standards of the aluminum extrusion industry. Profile drawings are illustrative and rounded to the nearest 1/16".

CURRENT PRICE as of April 1, 2022



COMMERCIAL

Unassembled Single Face Kits w/ Reveal - For Flexible Faces

Slimline Single Face Body w/ Tension Frame and 1-1/2" Tension Frame Cover

Part #2020
K2020/85/84

Part #2085

Part #2084

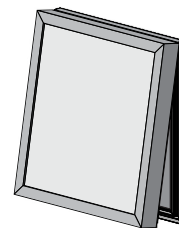
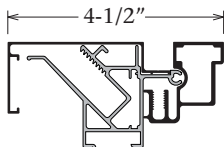

Size H'xW'	Mill Finish	Dk. Bronze	Size H'xW'	Mill Finish	Dk. Bronze	Size H'xW'	Mill Finish	Dk. Bronze	Size H'xW'	Mill Finish	Dk. Bronze
2 x 3	\$400	\$478	4 x 4	\$518	\$617	6 x 6	\$682	\$804	8 x 14	\$1088	\$1279
2 x 4	440	518	4 x 5	560	662	6 x 7	725	853	8 x 15	1130	1332
2 x 5	483	569	4 x 6	601	714	6 x 8	761	899	8 x 16	1167	1375
2 x 6	522	622	4 x 7	643	761	6 x 9	807	954	8 x 17	1211	1423
2 x 7	562	670	4 x 8	682	804	6 x 10	844	999	8 x 18	1249	1471
2 x 8	599	710	4 x 9	728	856	6 x 11	887	1046	8 x 19	1291	1520
2 x 9	646	762	4 x 10	762	902	6 x 12	924	1090	8 x 20	1332	1565
2 x 10	688	809	4 x 11	807	954	6 x 13	969	1142			
2 x 11	728	856	4 x 12	849	1003	6 x 14	1006	1189	9 x 9	927	1090
2 x 12	768	907	4 x 13	888	1051	6 x 15	1053	1241	9 x 10	964	1137
2 x 13	809	956	4 x 14	927	1090	6 x 16	1094	1285	9 x 11	1006	1189
2 x 14	849	1003	4 x 15	972	1144	6 x 17	1134	1335	9 x 12	1050	1233
2 x 15	890	1053	4 x 16	1011	1192	6 x 18	1173	1382	9 x 13	1094	1285
2 x 16	932	1098	4 x 17	1053	1241	6 x 19	1213	1427	9 x 14	1128	1330
2 x 17	972	1144	4 x 18	1097	1288	6 x 20	1253	1474	9 x 15	1173	1382
2 x 18	1013	1195	4 x 19	1136	1336				9 x 16	1211	1423
2 x 19	1054	1243	4 x 20	1176	1384	7 x 7	762	902	9 x 17	1253	1474
2 x 20	1097	1288				7 x 8	800	944	9 x 18	1291	1520
			5 x 5	599	710	7 x 9	845	1002	9 x 19	1336	1574
3 x 3	443	524	5 x 6	643	761	7 x 10	885	1042	9 x 20	1375	1616
3 x 4	485	574	5 x 7	683	807	7 x 11	927	1090			
3 x 5	522	622	5 x 8	721	851	7 x 12	966	1141	10 x 10	1002	1181
3 x 6	563	671	5 x 9	767	904	7 x 13	1009	1190	10 x 11	1043	1228
3 x 7	602	716	5 x 10	804	947	7 x 14	1050	1233	10 x 12	1088	1279
3 x 8	646	762	5 x 11	845	1002	7 x 15	1095	1287	10 x 13	1128	1330
3 x 9	690	816	5 x 12	888	1051	7 x 16	1130	1332	10 x 14	1165	1372
3 x 10	729	857	5 x 13	928	1095	7 x 17	1173	1382	10 x 15	1211	1423
3 x 11	768	907	5 x 14	966	1141	7 x 18	1212	1426	10 x 16	1248	1470
3 x 12	811	958	5 x 15	1011	1192	7 x 19	1255	1477	10 x 17	1290	1518
3 x 13	855	1004	5 x 16	1053	1241	7 x 20	1291	1520	10 x 18	1332	1565
3 x 14	890	1053	5 x 17	1095	1287				10 x 19	1375	1616
3 x 15	938	1104	5 x 18	1136	1336	8 x 8	840	990	10 x 20	1413	1661
3 x 16	974	1145	5 x 19	1176	1384	8 x 9	885	1042			
3 x 17	1013	1195	5 x 20	1213	1427	8 x 10	923	1086			
3 x 18	1055	1244				8 x 11	964	1137			
3 x 19	1100	1295				8 x 12	1004	1186			
3 x 20	1137	1339				8 x 13	1050	1233			

Kits Include:

- Mill Finish or Dk. Bronze
- Cut to size and mitered bodies
- Cut to size and mitered frames with covers
- Tension Clips
- Frame Braces (Part #5352)
- All screws required to assemble by mechanical fastening
- All Corner Angles and/or Corner Keys required
- Packaging

Not Included in Kits:

- Face or Back
- Electrical Components
- Back Braces and Gussets
- Frame Support Tube - See optional accessories
- Tension Tool - See optional accessories
- Mounting Provisions

Optional Accessories (pg 127):

- Frame Support Tube
- Tension Tool

Kit Specifications:

- Recommended for LED applications
- Custom size kits may be cut to any dimension
- Flexible Face Preparation - See page 129
- Frame Brace / Frame Support Tube placement - See page 130
- Tension Frame is not engineered to integrate with the Divider System

Additional Information (pgs 196-197)

UL Recognized Component Systems
The Underwriters Laboratory file number is E136850

Note: It is recommended to use safety chains and prop-bars on all hingeable faces.

US Patent Numbers 6,061,941 / 6,637,080
CA Patent Numbers 2,245,623 / 2,387,222

Unassembled Single Face Kits w/ Reveal - For Flexible Faces

Narrow Single Face Body w/ Tension Frame and 1-1/2" Tension Frame Cover

Part #2021
K2021/85/84

Part #2085

Part #2084

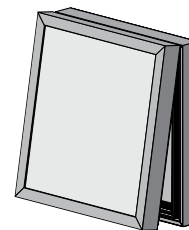
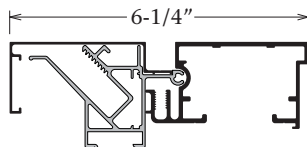

Size H'xW'	Mill Finish	Dk. Bronze	Size H'xW'	Mill Finish	Dk. Bronze	Size H'xW'	Mill Finish	Dk. Bronze	Size H'xW'	Mill Finish	Dk. Bronze
2 x 3	\$431	\$519	4 x 4	\$564	\$682	6 x 6	\$752	\$902	8 x 14	\$1217	\$1458
2 x 4	475	567	4 x 5	613	734	6 x 7	801	959	8 x 15	1265	1522
2 x 5	522	626	4 x 6	661	796	6 x 8	844	1013	8 x 16	1309	1572
2 x 6	569	688	4 x 7	708	852	6 x 9	896	1077	8 x 17	1358	1629
2 x 7	614	744	4 x 8	752	902	6 x 10	936	1130	8 x 18	1403	1684
2 x 8	658	795	4 x 9	804	962	6 x 11	987	1186	8 x 19	1451	1740
2 x 9	710	853	4 x 10	845	1015	6 x 12	1030	1239	8 x 20	1500	1794
2 x 10	756	907	4 x 11	896	1077	6 x 13	1082	1297			
2 x 11	804	962	4 x 12	942	1133	6 x 14	1122	1351	9 x 9	1031	1239
2 x 12	851	1022	4 x 13	988	1189	6 x 15	1174	1413	9 x 10	1077	1293
2 x 13	899	1079	4 x 14	1031	1239	6 x 16	1223	1466	9 x 11	1122	1351
2 x 14	942	1133	4 x 15	1083	1299	6 x 17	1269	1523	9 x 12	1172	1403
2 x 15	990	1190	4 x 16	1130	1355	6 x 18	1315	1578	9 x 13	1223	1466
2 x 16	1038	1247	4 x 17	1174	1413	6 x 19	1362	1633	9 x 14	1263	1518
2 x 17	1083	1299	4 x 18	1225	1469	6 x 20	1407	1687	9 x 15	1315	1578
2 x 18	1132	1358	4 x 19	1271	1525				9 x 16	1358	1629
2 x 19	1176	1415	4 x 20	1318	1580	7 x 7	845	1015	9 x 17	1407	1687
2 x 20	1225	1469				7 x 8	888	1067	9 x 18	1451	1740
			5 x 5	658	795	7 x 9	938	1132	9 x 19	1502	1803
3 x 3	478	575	5 x 6	708	852	7 x 10	985	1181	9 x 20	1548	1854
3 x 4	524	630	5 x 7	753	904	7 x 11	1031	1239			
3 x 5	569	688	5 x 8	797	956	7 x 12	1079	1296	10 x 10	1118	1344
3 x 6	615	745	5 x 9	849	1019	7 x 13	1128	1354	10 x 11	1167	1400
3 x 7	662	797	5 x 10	891	1069	7 x 14	1172	1403	10 x 12	1217	1458
3 x 8	710	853	5 x 11	938	1132	7 x 15	1224	1467	10 x 13	1263	1518
3 x 9	760	914	5 x 12	988	1189	7 x 16	1265	1522	10 x 14	1306	1569
3 x 10	805	963	5 x 13	1034	1243	7 x 17	1315	1578	10 x 15	1358	1629
3 x 11	851	1022	5 x 14	1079	1296	7 x 18	1360	1632	10 x 16	1402	1683
3 x 12	900	1081	5 x 15	1130	1355	7 x 19	1409	1688	10 x 17	1450	1739
3 x 13	948	1134	5 x 16	1174	1413	7 x 20	1451	1740	10 x 18	1500	1794
3 x 14	990	1190	5 x 17	1224	1467				10 x 19	1548	1854
3 x 15	1043	1251	5 x 18	1271	1525	8 x 8	934	1120	10 x 20	1589	1907
3 x 16	1085	1300	5 x 19	1318	1580	8 x 9	985	1181			
3 x 17	1132	1358	5 x 20	1362	1633	8 x 10	1029	1235			
3 x 18	1177	1416				8 x 11	1077	1293			
3 x 19	1228	1474				8 x 12	1121	1348			
3 x 20	1272	1526				8 x 13	1172	1403			

Kits Include:

- Mill Finish or Dk. Bronze
- Cut to size and mitered bodies
- Cut to size and mitered frames with covers
- Tension Clips
- Frame Braces (Part #5350)
- All screws required to assemble by mechanical fastening
- All Corner Angles and/or Corner Keys required
- Packaging

Not Included in Kits:

- Face or Back
- Electrical Components
- Back Braces and Gussets
- Frame Support Tube - See optional accessories
- Tension Tool - See optional accessories
- Mounting Provisions

Optional Accessories (pg 127):

- Frame Support Tube
- Tension Tool

Kit Specifications:

- **Recommended for LED applications**
- Custom size kits may be cut to any dimension
- Flexible Face Preparation - See page 129
- Frame Brace / Frame Support Tube placement - See page 130
- Tension Frame is not engineered to integrate with the Divider System

Additional Information (pgs 196-197)

Note: All dimensions are subject to the tolerance standards of the aluminum extrusion industry. Profile drawings are illustrative and rounded to the nearest 1/16".

CURRENT PRICE as of April 1, 2022



COMMERCIAL

Unassembled Single Face Kits w/ Reveal - For Flexible Faces

Single Face Body w/ Tension Frame and 1-1/2" Tension Frame Cover

Part #2025
KSF/85/84

Part #2085

Part #2084

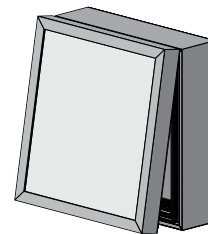
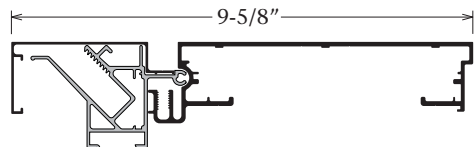

Size H'xW'	Mill Finish	Dk. Bronze	Size H'xW'	Mill Finish	Dk. Bronze	Size H'xW'	Mill Finish	Dk. Bronze	Size H'xW'	Mill Finish	Dk. Bronze
2 x 3	\$445	\$541	4 x 4	\$590	\$717	6 x 6	\$812	\$976	8 x 14	\$1358	\$1624
2 x 4	494	592	4 x 5	641	774	6 x 7	880	1051	8 x 15	1409	1692
2 x 5	544	655	4 x 6	704	849	6 x 8	923	1109	8 x 16	1454	1746
2 x 6	606	733	4 x 7	767	922	6 x 9	978	1177	8 x 17	1517	1818
2 x 7	666	805	4 x 8	812	976	6 x 10	1035	1247	8 x 18	1565	1878
2 x 8	714	859	4 x 9	868	1041	6 x 11	1088	1308	8 x 19	1630	1953
2 x 9	769	923	4 x 10	924	1113	6 x 12	1134	1363	8 x 20	1681	2012
2 x 10	831	995	4 x 11	978	1177	6 x 13	1201	1438	9 x 9	1136	1363
2 x 11	881	1054	4 x 12	1027	1237	6 x 14	1247	1498	9 x 10	1196	1434
2 x 12	931	1118	4 x 13	1089	1311	6 x 15	1300	1562	9 x 11	1247	1498
2 x 13	992	1190	4 x 14	1136	1363	6 x 16	1363	1630	9 x 12	1297	1554
2 x 14	1039	1249	4 x 15	1190	1427	6 x 17	1413	1693	9 x 13	1363	1630
2 x 15	1090	1312	4 x 16	1252	1501	6 x 18	1462	1754	9 x 14	1404	1687
2 x 16	1153	1382	4 x 17	1300	1562	6 x 19	1522	1822	9 x 15	1462	1754
2 x 17	1202	1439	4 x 18	1355	1621	6 x 20	1570	1881	9 x 16	1517	1818
2 x 18	1253	1504	4 x 19	1415	1695	7 x 7	936	1125	9 x 17	1570	1881
2 x 19	1314	1576	4 x 20	1465	1755	7 x 8	983	1180	9 x 18	1617	1940
2 x 20	1366	1633				7 x 9	1037	1248	9 x 19	1684	2018
			5 x 5	690	836	7 x 10	1098	1314	9 x 20	1732	2073
3 x 3	496	599	5 x 6	755	911	7 x 11	1148	1375	10 x 10	1253	1501
3 x 4	547	661	5 x 7	815	979	7 x 12	1197	1437	10 x 11	1304	1562
3 x 5	594	721	5 x 8	860	1035	7 x 13	1260	1511	10 x 12	1358	1624
3 x 6	655	795	5 x 9	915	1102	7 x 14	1309	1565	10 x 13	1416	1699
3 x 7	717	862	5 x 10	975	1170	7 x 15	1364	1632	10 x 14	1465	1755
3 x 8	769	923	5 x 11	1025	1236	7 x 16	1421	1703	10 x 15	1517	1818
3 x 9	821	988	5 x 12	1077	1299	7 x 17	1473	1764	10 x 16	1577	1890
3 x 10	883	1055	5 x 13	1137	1367	7 x 18	1518	1821	10 x 17	1629	1951
3 x 11	931	1118	5 x 14	1186	1425	7 x 19	1585	1895	10 x 18	1681	2012
3 x 12	983	1180	5 x 15	1240	1489	7 x 20	1630	1953	10 x 19	1744	2084
3 x 13	1046	1251	5 x 16	1300	1562	8 x 8	1031	1237	10 x 20	1790	2143
3 x 14	1090	1312	5 x 17	1354	1620	8 x 9	1086	1302			
3 x 15	1148	1375	5 x 18	1403	1683	8 x 10	1133	1359			
3 x 16	1204	1441	5 x 19	1465	1755	8 x 11	1196	1434			
3 x 17	1253	1504	5 x 20	1510	1810	8 x 12	1244	1494			
3 x 18	1303	1565				8 x 13	1297	1554			
3 x 19	1370	1640									
3 x 20	1416	1696									

Kits Include:

- Mill Finish or Dk. Bronze
- Cut to size and mitered bodies
- Cut to size and mitered frames with covers
- Tension Clips
- Frame Braces for LED applications (Part #5357)
- All screws required to assemble by mechanical fastening
- All Corner Angles and/or Corner Keys required
- Packaging

Not Included in Kits:

- Face or Back
- Electrical Components
- Ballast Bracket(s) - See optional accessories
- Back Braces and Gussets
- Frame Support Tube - See optional accessories
- Raceway Covers and Cover Screws- See optional accessories
- Tension Tool - See optional accessories
- Mounting Provisions

Optional Accessories (pg 127):

- Ballast Bracket(s)
- Frame Support Tube
- Raceway Covers and Cover Screws
- Tension Tool

Kit Specifications:

- It is recommended to order kits 1" over nominal T12 or T8 lamp size to utilize .040 flat Aluminum Raceway Covers
- Custom size kits may be cut to any dimension
- Flexible Face Preparation - See page 129
- Frame Brace / Frame Support Tube placement - See page 130
- Tension Frame is not engineered to integrate with the Divider System

Recommended Lamp Spacing:

- For illuminated backgrounds - 12" on center, using T12 or T8 lamps
- Always place lamps 3/4" from back of sign
- When using lamps, deduct \$6.01 per Frame Brace

Additional Information (pgs 196-197)

UL Recognized Component Systems
The Underwriters Laboratory file number is E136850

Note: It is recommended to use safety chains and prop-bars on all hingeable faces.

US Patent Numbers 6,061,941 / 6,637,080
CA Patent Numbers 2,245,623 / 2,387,222

Unassembled Double Face Kits w/ Reveal - For Flexible Faces

Medium Body w/ Tension Frame and 1-1/2" Tension Frame Cover

Part #2015
KMB/85/84

Part #2085

Part #2084

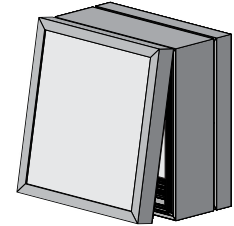
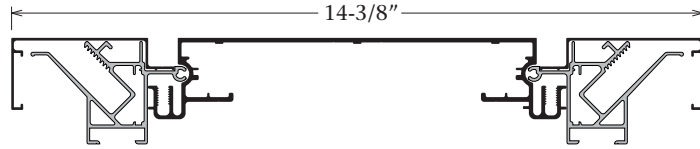

Size H'xW'	Mill Finish	Dk. Bronze	Size H'xW'	Mill Finish	Dk. Bronze	Size H'xW'	Mill Finish	Dk. Bronze	Size H'xW'	Mill Finish	Dk. Bronze
2 x 3	\$732	\$887	4 x 4	\$983	\$1189	6 x 6	\$1374	\$1647	8 x 14	\$2305	\$2758
2 x 4	813	985	4 x 5	1069	1291	6 x 7	1478	1775	8 x 15	2396	2869
2 x 5	900	1089	4 x 6	1178	1423	6 x 8	1560	1870	8 x 16	2477	2967
2 x 6	1009	1217	4 x 7	1288	1550	6 x 9	1655	1984	8 x 17	2586	3096
2 x 7	1120	1343	4 x 8	1372	1645	6 x 10	1758	2108	8 x 18	2674	3196
2 x 8	1199	1442	4 x 9	1462	1758	6 x 11	1843	2206	8 x 19	2782	3327
2 x 9	1290	1553	4 x 10	1564	1877	6 x 12	1930	2311	8 x 20	2864	3423
2 x 10	1397	1669	4 x 11	1651	1980	6 x 13	2040	2440	9 x 9	1932	2318
2 x 11	1478	1775	4 x 12	1736	2084	6 x 14	2119	2536	9 x 10	2033	2435
2 x 12	1569	1878	4 x 13	1847	2214	6 x 15	2210	2647	9 x 11	2120	2537
2 x 13	1680	2008	4 x 14	1926	2307	6 x 16	2311	2765	9 x 12	2206	2643
2 x 14	1758	2108	4 x 15	2020	2421	6 x 17	2398	2870	9 x 13	2317	2770
2 x 15	1849	2216	4 x 16	2120	2537	6 x 18	2481	2975	9 x 14	2394	2864
2 x 16	1954	2335	4 x 17	2207	2646	6 x 19	2598	3103	9 x 15	2487	2976
2 x 17	2040	2440	4 x 18	2294	2750	6 x 20	2675	3200	9 x 16	2594	3101
2 x 18	2121	2540	4 x 19	2401	2877	7 x 7	1589	1901	9 x 17	2677	3201
2 x 19	2233	2671	4 x 20	2480	2972	7 x 8	1672	1997	9 x 18	2763	3307
2 x 20	2317	2770				7 x 9	1762	2111	9 x 19	2873	3435
			5 x 5	1153	1395	7 x 10	1862	2228	9 x 20	2954	3530
3 x 3	825	999	5 x 6	1263	1518	7 x 11	1953	2333	10 x 10	2135	2554
3 x 4	902	1094	5 x 7	1375	1651	7 x 12	2035	2436	10 x 11	2221	2655
3 x 5	988	1199	5 x 8	1453	1748	7 x 13	2144	2564	10 x 12	2307	2761
3 x 6	1100	1325	5 x 9	1546	1861	7 x 14	2223	2659	10 x 13	2417	2888
3 x 7	1211	1453	5 x 10	1649	1977	7 x 15	2319	2775	10 x 14	2497	2986
3 x 8	1288	1550	5 x 11	1736	2084	7 x 16	2420	2893	10 x 15	2588	3099
3 x 9	1379	1661	5 x 12	1821	2186	7 x 17	2507	2999	10 x 16	2695	3217
3 x 10	1485	1782	5 x 13	1932	2318	7 x 18	2596	3102	10 x 17	2780	3321
3 x 11	1570	1883	5 x 14	2009	2412	7 x 19	2702	3226	10 x 18	2865	3426
3 x 12	1657	1990	5 x 15	2100	2521	7 x 20	2782	3327	10 x 19	2977	3553
3 x 13	1768	2116	5 x 16	2206	2643	8 x 8	1751	2093	10 x 20	3055	3650
3 x 14	1847	2214	5 x 17	2294	2750	8 x 9	1838	2204			
3 x 15	1941	2325	5 x 18	2376	2849	8 x 10	1923	2305			
3 x 16	2044	2445	5 x 19	2487	2976	8 x 11	2030	2426			
3 x 17	2128	2547	5 x 20	2568	3075	8 x 12	2116	2535			
3 x 18	2214	2651				8 x 13	2200	2635			
3 x 19	2323	2778									
3 x 20	2401	2877									

Kits Include:

- Mill Finish or Dk. Bronze
- Cut to size and mitered bodies
- Cut to size and mitered frames with covers
- Tension Clips
- Frame Braces for LED applications (Part #5357)
- All screws required to assemble by mechanical fastening
- All Corner Angles and/or Corner Keys required
- Packaging

Not Included in Kits:

- Faces
- Electrical Components
- Ballast Bracket(s) - See optional accessories
- Internal Supports
- Frame Support Tube - See optional accessories
- Raceway Covers and Cover Screws- See optional accessories
- Tension Tool - See optional accessories

Optional Accessories (pg 127):

- Ballast Bracket(s)
- Frame Support Tube
- Raceway Covers and Cover Screws
- Tension Tool

Kit Specifications:

- It is recommended to order kits 1" over nominal T12 or T8 lamp size to utilize .040 flat Aluminum Raceway Covers
- Custom size kits may be cut to any dimension
- Flexible Face Preparation - See page 129
- Frame Brace / Frame Support Tube placement - See page 130
- Tension Frame is not engineered to integrate with the Divider System

Recommended Lamp Spacing:

- For illuminated backgrounds - 12" on center, using T12 or T8 lamps
- When using lamps, deduct \$6.01 per Frame Brace

Additional Information (pgs 196-197)

Note: All dimensions are subject to the tolerance standards of the aluminum extrusion industry. Profile drawings are illustrative and rounded to the nearest 1/16".

CURRENT PRICE as of April 1, 2022



COMMERCIAL

Unassembled Double Face Kits w/ Reveal - For Flexible Faces

Wide Body w/ Tension Frame and 1-1/2" Tension Frame Cover

Part #2005
KWB/85/84

Part #2085

Part #2084

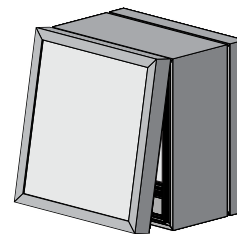
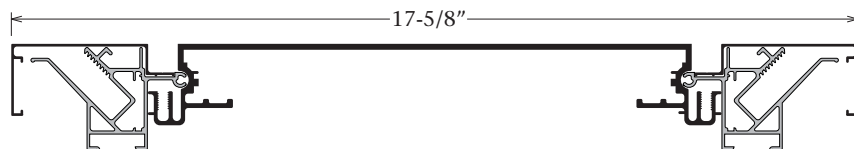

Size H'xW'	Mill Finish	Dk. Bronze	Size H'xW'	Mill Finish	Dk. Bronze	Size H'xW'	Mill Finish	Dk. Bronze	Size H'xW'	Mill Finish	Dk. Bronze
2 x 3	\$824	\$995	4 x 4	\$1113	\$1347	6 x 6	\$1554	\$1870	8 x 14	\$2627	\$3146
2 x 4	916	1109	4 x 5	1211	1465	6 x 7	1680	2014	8 x 15	2734	3277
2 x 5	1014	1228	4 x 6	1336	1609	6 x 8	1774	2127	8 x 16	2830	3391
2 x 6	1138	1372	4 x 7	1458	1754	6 x 9	1878	2254	8 x 17	2951	3534
2 x 7	1260	1517	4 x 8	1550	1869	6 x 10	1997	2396	8 x 18	3051	3656
2 x 8	1355	1629	4 x 9	1660	2001	6 x 11	2096	2515	8 x 19	3178	3801
2 x 9	1465	1759	4 x 10	1778	2137	6 x 12	2196	2638	8 x 20	3269	3915
2 x 10	1577	1894	4 x 11	1875	2253	6 x 13	2318	2781	9 x 9	2199	2639
2 x 11	1680	2014	4 x 12	1976	2374	6 x 14	2414	2892	9 x 10	2314	2777
2 x 12	1779	2139	4 x 13	2100	2521	6 x 15	2521	3023	9 x 11	2416	2896
2 x 13	1902	2279	4 x 14	2194	2635	6 x 16	2634	3158	9 x 12	2517	3018
2 x 14	1997	2396	4 x 15	2303	2761	6 x 17	2735	3281	9 x 13	2638	3165
2 x 15	2105	2523	4 x 16	2419	2898	6 x 18	2837	3396	9 x 14	2733	3275
2 x 16	2222	2662	4 x 17	2520	3020	6 x 19	2963	3549	9 x 15	2838	3404
2 x 17	2318	2781	4 x 18	2622	3143	6 x 20	3052	3659	9 x 16	2955	3538
2 x 18	2421	2900	4 x 19	2738	3282	7 x 7	1803	2162	9 x 17	3054	3660
2 x 19	2544	3046	4 x 20	2833	3395	7 x 8	1894	2275	9 x 18	3157	3779
2 x 20	2634	3158				7 x 9	2001	2400	9 x 19	3280	3923
			5 x 5	1311	1584	7 x 10	2119	2536	9 x 20	3371	4041
3 x 3	924	1118	5 x 6	1434	1728	7 x 11	2219	2661	10 x 10	2428	2911
3 x 4	1019	1235	5 x 7	1556	1871	7 x 12	2317	2778	10 x 11	2531	3033
3 x 5	1118	1351	5 x 8	1653	1985	7 x 13	2442	2921	10 x 12	2631	3150
3 x 6	1239	1497	5 x 9	1758	2119	7 x 14	2537	3036	10 x 13	2756	3299
3 x 7	1367	1644	5 x 10	1875	2253	7 x 15	2644	3166	10 x 14	2849	3411
3 x 8	1462	1758	5 x 11	1973	2373	7 x 16	2758	3303	10 x 15	2954	3537
3 x 9	1568	1882	5 x 12	2073	2492	7 x 17	2861	3422	10 x 16	3071	3677
3 x 10	1683	2024	5 x 13	2202	2640	7 x 18	2961	3541	10 x 17	3173	3799
3 x 11	1783	2144	5 x 14	2291	2753	7 x 19	3082	3685	10 x 18	3269	3915
3 x 12	1881	2262	5 x 15	2400	2882	7 x 20	3178	3801	10 x 19	3394	4064
3 x 13	2008	2410	5 x 16	2520	3020	8 x 8	1992	2385	10 x 20	3489	4175
3 x 14	2100	2521	5 x 17	2614	3142	8 x 9	2095	2512			
3 x 15	2210	2650	5 x 18	2715	3259	8 x 10	2188	2627			
3 x 16	2326	2784	5 x 19	2838	3404	8 x 11	2311	2770			
3 x 17	2425	2907	5 x 20	2931	3514	8 x 12	2413	2891			
3 x 18	2524	3026				8 x 13	2515	3012			
3 x 19	2649	3170									
3 x 20	2740	3284									

Kits Include:

- Mill Finish or Dk. Bronze
- Cut to size and mitered bodies
- Cut to size and mitered frames with covers
- Tension Clips
- Frame Braces for LED applications (Part #5357)
- All screws required to assemble by mechanical fastening
- All Corner Angles and/or Corner Keys required
- Packaging

Not Included in Kits:

- Faces
- Electrical Components
- Ballast Bracket(s) - See optional accessories
- Internal Supports
- Frame Support Tube - See optional accessories
- Raceway Covers and Cover Screws- See optional accessories
- Tension Tool - See optional accessories

Optional Accessories (pg 127):

- Ballast Bracket(s)
- Frame Support Tube
- Raceway Covers and Cover Screws
- Tension Tool

Kit Specifications:

- It is recommended to order kits 1" over nominal T12 or T8 lamp size to utilize .040 flat Aluminum Raceway Covers
- Custom size kits may be cut to any dimension
- Flexible Face Preparation - See page 129
- Frame Brace / Frame Support Tube placement - See page 130
- Tension Frame is not engineered to integrate with the Divider System

Recommended Lamp Spacing:

- For illuminated backgrounds - 12" on center, using T12 or T8 lamps
- When using lamps, deduct \$6.01 per Frame Brace

Additional Information (pgs 196-197)

UL Recognized Component Systems
The Underwriters Laboratory file number is E136850

Note: It is recommended to use safety chains and prop-bars on all hingeable faces.

US Patent Numbers 6,061,941 / 6,637,080
CA Patent Numbers 2,245,623 / 2,387,222

Unassembled Retro Kits w/ Reveal - For Vandal Retainers

Retro Body w/ Inner Frame and Outer Frame

Part #2040
K2040/99/42

Part #2099

Part #1942

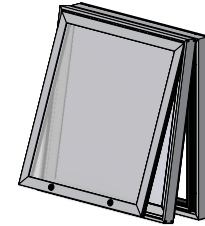
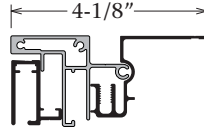

Size H'xW'	Mill Finish	Size H'xW'	Mill Finish	Size H'xW'	Mill Finish	Size H'xW'	Mill Finish
2 x 3	\$301	4 x 4	\$435	6 x 6	\$618	8 x 14	\$1092
2 x 4	348	4 x 5	484	6 x 7	670	8 x 15	1144
2 x 5	395	4 x 6	534	6 x 8	717	8 x 16	1188
2 x 6	444	4 x 7	579	6 x 9	767	8 x 17	1239
2 x 7	494	4 x 8	627	6 x 10	813	8 x 18	1288
2 x 8	539	4 x 9	677	6 x 11	860	8 x 19	1335
2 x 9	591	4 x 10	724	6 x 12	911	8 x 20	1382
2 x 10	641	4 x 11	774	6 x 13	956		
2 x 11	688	4 x 12	823	6 x 14	1006	9 x 9	897
2 x 12	733	4 x 13	874	6 x 15	1055	9 x 10	944
2 x 13	784	4 x 14	918	6 x 16	1100	9 x 11	992
2 x 14	829	4 x 15	969	6 x 17	1153	9 x 12	1039
2 x 15	880	4 x 16	1014	6 x 18	1199	9 x 13	1088
2 x 16	931	4 x 17	1061	6 x 19	1247	9 x 14	1137
2 x 17	976	4 x 18	1113	6 x 20	1296	9 x 15	1184
2 x 18	1025	4 x 19	1161			9 x 16	1236
2 x 19	1073	4 x 20	1207	7 x 7	714	9 x 17	1280
2 x 20	1118			7 x 8	760	9 x 18	1330
		5 x 5	526	7 x 9	805	9 x 19	1379
3 x 3	345	5 x 6	576	7 x 10	857	9 x 20	1426
3 x 4	392	5 x 7	623	7 x 11	904		
3 x 5	439	5 x 8	673	7 x 12	953	10 x 10	985
3 x 6	491	5 x 9	720	7 x 13	1003	10 x 11	1037
3 x 7	536	5 x 10	771	7 x 14	1050	10 x 12	1083
3 x 8	587	5 x 11	820	7 x 15	1097	10 x 13	1132
3 x 9	637	5 x 12	865	7 x 16	1146	10 x 14	1181
3 x 10	681	5 x 13	914	7 x 17	1195	10 x 15	1228
3 x 11	730	5 x 14	963	7 x 18	1241	10 x 16	1277
3 x 12	778	5 x 15	1010	7 x 19	1293	10 x 17	1325
3 x 13	827	5 x 16	1058	7 x 20	1340	10 x 18	1375
3 x 14	876	5 x 17	1109			10 x 19	1422
3 x 15	923	5 x 18	1157	8 x 8	801	10 x 20	1470
3 x 16	974	5 x 19	1202	8 x 9	853		
3 x 17	1021	5 x 20	1255	8 x 10	902		
3 x 18	1067			8 x 11	948		
3 x 19	1116			8 x 12	998		
3 x 20	1165			8 x 13	1043		

Kits Include:

- Mill Finish
- Cut to size and mitered bodies
- Cut to size and mitered Inner/Outer Frame Retainers
- All screws required to assemble by mechanical fastening
- All Corner Angles and/or Corner Keys required
- Cut to size 2Part Hinge
- Two (2) 2Part Locks and One (1) 2Part Lock Wrench
- Packaging
- Prices reflect one (1) Retro Body kit, SINGLE FACE APPLICATION

Kit Specifications:

- Kits will be cut .265" larger to fit over existing structure
- Custom size kits may be cut to any dimension
- Illumination may vary depending on application
- Vandal Retainer is not designed to be used with SignComp Gas Supports

Additional Information (pgs 196-197)

Not Included in Kits:

- Faces
- Electrical Components
- Drilling of holes for locks
- Attachment of locks and hinge
- Mounting Provisions

Note: It is recommended to use safety chains and prop-bars on all hingeable faces.

Note: All dimensions are subject to the tolerance standards of the aluminum extrusion industry. Profile drawings are illustrative and rounded to the nearest 1/16".

CURRENT PRICE as of April 1, 2022



COMMERCIAL

Unassembled Single Face Kits w/ Reveal - For Vandal Retainers

Slimline Single Face Body w/ Inner Frame and Outer Frame

Part #2020
K2020/99/42

Part #2099

Part #1942

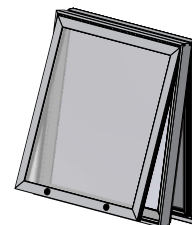
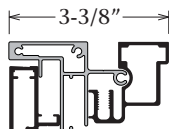

Size H'xW'	Mill Finish	Dk. Bronze	Size H'xW'	Mill Finish	Dk. Bronze	Size H'xW'	Mill Finish	Dk. Bronze	Size H'xW'	Mill Finish	Dk. Bronze
2 x 3	\$312	\$400	4 x 4	\$457	\$592	6 x 6	\$651	\$852	8 x 14	\$1150	\$1523
2 x 4	364	469	4 x 5	507	664	6 x 7	704	923	8 x 15	1205	1593
2 x 5	413	539	4 x 6	560	730	6 x 8	753	990	8 x 16	1251	1663
2 x 6	467	607	4 x 7	607	799	6 x 9	805	1060	8 x 17	1304	1728
2 x 7	518	674	4 x 8	661	865	6 x 10	857	1129	8 x 18	1358	1795
2 x 8	566	745	4 x 9	710	934	6 x 11	906	1196	8 x 19	1406	1867
2 x 9	618	809	4 x 10	761	1006	6 x 12	959	1264	8 x 20	1457	1937
2 x 10	673	880	4 x 11	812	1073	6 x 13	1006	1331			
2 x 11	721	951	4 x 12	865	1138	6 x 14	1058	1402	9 x 9	944	1244
2 x 12	771	1018	4 x 13	918	1208	6 x 15	1111	1469	9 x 10	994	1311
2 x 13	824	1088	4 x 14	966	1277	6 x 16	1160	1537	9 x 11	1045	1382
2 x 14	874	1156	4 x 15	1019	1343	6 x 17	1213	1608	9 x 12	1095	1450
2 x 15	924	1221	4 x 16	1067	1416	6 x 18	1264	1677	9 x 13	1146	1516
2 x 16	979	1291	4 x 17	1117	1483	6 x 19	1314	1742	9 x 14	1197	1586
2 x 17	1026	1360	4 x 18	1172	1550	6 x 20	1366	1812	9 x 15	1248	1655
2 x 18	1077	1430	4 x 19	1221	1621				9 x 16	1302	1724
2 x 19	1130	1497	4 x 20	1269	1687	7 x 7	750	983	9 x 17	1350	1790
2 x 20	1177	1564				7 x 8	799	1051	9 x 18	1402	1861
			5 x 5	552	724	7 x 9	849	1118	9 x 19	1454	1926
3 x 3	361	464	5 x 6	603	793	7 x 10	903	1188	9 x 20	1502	1997
3 x 4	411	532	5 x 7	655	860	7 x 11	953	1259			
3 x 5	460	598	5 x 8	706	930	7 x 12	1003	1327	10 x 10	1038	1375
3 x 6	515	669	5 x 9	756	994	7 x 13	1055	1394	10 x 11	1092	1441
3 x 7	563	738	5 x 10	809	1066	7 x 14	1105	1465	10 x 12	1142	1510
3 x 8	615	805	5 x 11	862	1134	7 x 15	1157	1529	10 x 13	1192	1580
3 x 9	669	875	5 x 12	911	1202	7 x 16	1208	1598	10 x 14	1244	1649
3 x 10	716	944	5 x 13	962	1272	7 x 17	1259	1671	10 x 15	1296	1714
3 x 11	768	1010	5 x 14	1013	1339	7 x 18	1309	1737	10 x 16	1347	1784
3 x 12	817	1079	5 x 15	1063	1409	7 x 19	1363	1804	10 x 17	1397	1853
3 x 13	871	1148	5 x 16	1114	1474	7 x 20	1410	1874	10 x 18	1450	1922
3 x 14	922	1216	5 x 17	1167	1544				10 x 19	1498	1992
3 x 15	972	1284	5 x 18	1217	1614	8 x 8	845	1111	10 x 20	1550	2055
3 x 16	1022	1355	5 x 19	1267	1683	8 x 9	899	1181			
3 x 17	1073	1421	5 x 20	1323	1752	8 x 10	950	1251			
3 x 18	1122	1488				8 x 11	998	1316			
3 x 19	1174	1557				8 x 12	1051	1388			
3 x 20	1225	1625				8 x 13	1100	1455			

Kits Include:

- Mill Finish or Dk. Bronze
- Cut to size and mitered bodies
- Cut to size and mitered Inner/Outer Frame Retainers
- All screws required to assemble by mechanical fastening
- All Corner Angles and/or Corner Keys required
- Cut to size 2Part Hinge
- Two (2) 2Part Locks and One (1) 2Part Lock Wrench
- Packaging

Not Included in Kits:

- Faces or Back
- Electrical Components
- Back Braces and Gussets
- Drilling of holes for locks
- Attachment of locks and hinge
- Mounting Provisions

Kit Specifications:

- Recommended for LED applications
- Custom size kits may be cut to any dimension
- Vandal Retainer is not designed to be used with SignComp Gas Supports

Additional Information (pgs 196-197)

Note: It is recommended to use safety chains and prop-bars on all hingeable faces.

Unassembled Single Face Kits w/ Reveal - For Vandal Retainers

Narrow Single Face Body w/ Inner Frame and Outer Frame

Part #2021
K2021/99/42

Part #2099

Part #1942

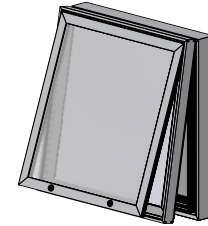
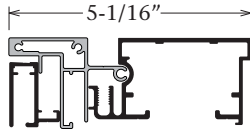

Size H'xW'	Mill Finish	Dk. Bronze	Size H'xW'	Mill Finish	Dk. Bronze	Size H'xW'	Mill Finish	Dk. Bronze	Size H'xW'	Mill Finish	Dk. Bronze
2 x 3	\$341	\$441	4 x 4	\$503	\$657	6 x 6	\$721	\$950	8 x 14	\$1280	\$1703
2 x 4	399	519	4 x 5	560	736	6 x 7	780	1029	8 x 15	1340	1782
2 x 5	455	597	4 x 6	618	812	6 x 8	836	1105	8 x 16	1393	1859
2 x 6	514	673	4 x 7	673	888	6 x 9	895	1183	8 x 17	1453	1933
2 x 7	570	748	4 x 8	730	963	6 x 10	951	1259	8 x 18	1511	2009
2 x 8	625	827	4 x 9	788	1039	6 x 11	1006	1335	8 x 19	1565	2089
2 x 9	683	900	4 x 10	844	1120	6 x 12	1065	1410	8 x 20	1624	2165
2 x 10	744	978	4 x 11	902	1196	6 x 13	1117	1486	9 x 9	1051	1393
2 x 11	797	1057	4 x 12	959	1269	6 x 14	1176	1564	9 x 10	1106	1466
2 x 12	853	1133	4 x 13	1018	1346	6 x 15	1235	1639	9 x 11	1164	1546
2 x 13	912	1211	4 x 14	1071	1425	6 x 16	1288	1716	9 x 12	1218	1621
2 x 14	966	1285	4 x 15	1132	1498	6 x 17	1348	1795	9 x 13	1275	1695
2 x 15	1025	1360	4 x 16	1186	1578	6 x 18	1404	1871	9 x 14	1332	1775
2 x 16	1085	1439	4 x 17	1240	1655	6 x 19	1461	1946	9 x 15	1390	1850
2 x 17	1137	1516	4 x 18	1300	1731	6 x 20	1520	2024	9 x 16	1450	1928
2 x 18	1195	1593	4 x 19	1356	1809	7 x 7	832	1098	9 x 17	1504	2002
2 x 19	1252	1667	4 x 20	1410	1883	7 x 8	887	1173	9 x 18	1561	2080
2 x 20	1306	1744				7 x 9	942	1249	9 x 19	1621	2155
			5 x 5	613	807	7 x 10	1003	1325	9 x 20	1676	2234
3 x 3	396	515	5 x 6	670	883	7 x 11	1058	1406	10 x 10	1157	1538
3 x 4	450	590	5 x 7	725	959	7 x 12	1114	1482	10 x 11	1216	1611
3 x 5	507	664	5 x 8	783	1035	7 x 13	1173	1557	10 x 12	1271	1691
3 x 6	567	742	5 x 9	839	1110	7 x 14	1227	1635	10 x 13	1327	1768
3 x 7	622	821	5 x 10	899	1189	7 x 15	1285	1709	10 x 14	1387	1844
3 x 8	681	896	5 x 11	956	1265	7 x 16	1343	1786	10 x 15	1443	1919
3 x 9	738	974	5 x 12	1010	1342	7 x 17	1400	1866	10 x 16	1501	1997
3 x 10	792	1051	5 x 13	1067	1421	7 x 18	1455	1942	10 x 17	1557	2073
3 x 11	851	1125	5 x 14	1125	1494	7 x 19	1517	2017	10 x 18	1616	2151
3 x 12	906	1201	5 x 15	1181	1573	7 x 20	1572	2095	10 x 19	1671	2230
3 x 13	963	1279	5 x 16	1237	1647	8 x 8	938	1241	10 x 20	1728	2302
3 x 14	1021	1354	5 x 17	1296	1724	8 x 9	998	1319			
3 x 15	1077	1431	5 x 18	1351	1803	8 x 10	1055	1398			
3 x 16	1134	1510	5 x 19	1407	1879	8 x 11	1110	1471			
3 x 17	1192	1584	5 x 20	1470	1957	8 x 12	1168	1550			
3 x 18	1247	1660				8 x 13	1223	1627			
3 x 19	1303	1737									
3 x 20	1362	1814									

Kits Include:

- Mill Finish or Dk. Bronze
- Cut to size and mitered bodies
- Cut to size and mitered Inner/Outer Frame Retainers
- All screws required to assemble by mechanical fastening
- All Corner Angles and/or Corner Keys required
- Cut to size 2Part Hinge
- Two (2) 2Part Locks and One (1) 2Part Lock Wrench
- Packaging

Not Included in Kits:

- Faces or Back
- Electrical Components
- Back Braces and Gussets
- Drilling of holes for locks
- Attachment of locks and hinge
- Mounting Provisions

Kit Specifications:

- **Recommended for LED applications**
- Custom size kits may be cut to any dimension
- Vandal Retainer is not designed to be used with SignComp Gas Supports

Additional Information (pgs 196-197)

Note: It is recommended to use safety chains and prop-bars on all hingeable faces.

Note: All dimensions are subject to the tolerance standards of the aluminum extrusion industry. Profile drawings are illustrative and rounded to the nearest 1/16".

CURRENT PRICE as of April 1, 2022



COMMERCIAL

Unassembled Single Face Kits w/ Reveal - For Vandal Retainers

Single Face Body w/ Inner Frame and Outer Frame

Part #2025
KSF/99/42

Part #2099

Part #1942

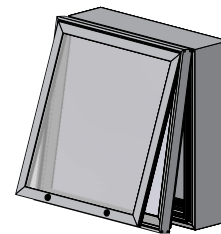
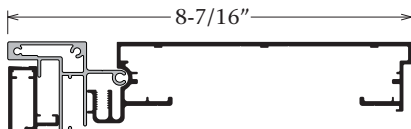

Size H'xW'	Mill Finish	Dk. Bronze	Size H'xW'	Mill Finish	Dk. Bronze	Size H'xW'	Mill Finish	Dk. Bronze	Size H'xW'	Mill Finish	Dk. Bronze
2 x 3	\$357	\$463	4 x 4	\$528	\$692	6 x 6	\$758	\$1002	8 x 14	\$1348	\$1795
2 x 4	417	544	4 x 5	587	776	6 x 7	821	1085	8 x 15	1410	1879
2 x 5	475	626	4 x 6	649	855	6 x 8	880	1164	8 x 16	1467	1961
2 x 6	538	706	4 x 7	706	935	6 x 9	939	1247	8 x 17	1529	2039
2 x 7	598	785	4 x 8	768	1014	6 x 10	1002	1327	8 x 18	1590	2120
2 x 8	655	869	4 x 9	828	1095	6 x 11	1058	1407	8 x 19	1649	2203
2 x 9	718	947	4 x 10	887	1180	6 x 12	1120	1486	8 x 20	1709	2283
2 x 10	780	1029	4 x 11	948	1260	6 x 13	1176	1569			
2 x 11	837	1113	4 x 12	1009	1339	6 x 14	1239	1651	9 x 9	1106	1469
2 x 12	897	1192	4 x 13	1070	1419	6 x 15	1299	1730	9 x 10	1165	1546
2 x 13	959	1274	4 x 14	1129	1501	6 x 16	1356	1810	9 x 11	1225	1632
2 x 14	1015	1354	4 x 15	1190	1578	6 x 17	1421	1894	9 x 12	1284	1711
2 x 15	1077	1432	4 x 16	1248	1664	6 x 18	1479	1974	9 x 13	1344	1788
2 x 16	1141	1516	4 x 17	1304	1744	6 x 19	1537	2052	9 x 14	1404	1871
2 x 17	1196	1596	4 x 18	1370	1823	6 x 20	1600	2135	9 x 15	1465	1953
2 x 18	1257	1679	4 x 19	1427	1907				9 x 16	1526	2035
2 x 19	1318	1758	4 x 20	1485	1986	7 x 7	876	1158	9 x 17	1584	2114
2 x 20	1375	1838				7 x 8	934	1237	9 x 18	1644	2196
			5 x 5	643	849	7 x 9	991	1318	9 x 19	1707	2275
3 x 3	415	539	5 x 6	704	930	7 x 10	1055	1398	9 x 20	1763	2357
3 x 4	472	618	5 x 7	762	1010	7 x 11	1114	1482			
3 x 5	532	698	5 x 8	824	1090	7 x 12	1173	1562	10 x 10	1218	1624
3 x 6	595	780	5 x 9	883	1168	7 x 13	1236	1641	10 x 11	1280	1702
3 x 7	653	862	5 x 10	944	1252	7 x 14	1293	1725	10 x 12	1340	1784
3 x 8	716	942	5 x 11	1006	1332	7 x 15	1354	1803	10 x 13	1398	1866
3 x 9	776	1025	5 x 12	1063	1415	7 x 16	1415	1883	10 x 14	1461	1946
3 x 10	831	1106	5 x 13	1122	1497	7 x 17	1474	1969	10 x 15	1520	2024
3 x 11	895	1184	5 x 14	1184	1574	7 x 18	1532	2048	10 x 16	1580	2107
3 x 12	953	1265	5 x 15	1243	1657	7 x 19	1596	2127	10 x 17	1639	2187
3 x 13	1013	1347	5 x 16	1302	1736	7 x 20	1653	2210	10 x 18	1702	2271
3 x 14	1073	1426	5 x 17	1364	1816				10 x 19	1759	2353
3 x 15	1133	1507	5 x 18	1423	1900	8 x 8	988	1311	10 x 20	1819	2429
3 x 16	1193	1590	5 x 19	1482	1982	8 x 9	1051	1393			
3 x 17	1253	1668	5 x 20	1546	2063	8 x 10	1111	1474			
3 x 18	1312	1751				8 x 11	1168	1553			
3 x 19	1372	1831				8 x 12	1232	1636			
3 x 20	1432	1911				8 x 13	1288	1716			

Kits Include:

- Mill Finish or Dk. Bronze
- Cut to size and mitered bodies
- Cut to size and mitered Inner/Outer Frame Retainers
- All screws required to assemble by mechanical fastening
- All Corner Angles and/or Corner Keys required
- Cut to size 2Part Hinge
- Two (2) 2Part Locks and One (1) 2Part Lock Wrench
- Packaging

Not Included in Kits:

- Faces or Back
- Electrical Components
- Ballast Bracket(s) - See optional accessories
- Back Braces and Gussets
- Drilling of holes for locks
- Attachment of locks and hinge
- Raceway Covers and Cover Screws - See optional accessories
- Mounting Provisions

Optional Accessories (pg 127):

- Ballast Bracket(s)
- Raceway Covers and Cover Screws

Kit Specifications:

- It is recommended to order kits 1" over nominal T12 or T8 lamp size to utilize .040 flat Aluminum Raceway Covers.
- Custom size kits may be cut to any dimension
- Vandal Retainer is not designed to be used with SignComp Gas Supports

Recommended Lamp Spacing:

- For illuminated backgrounds - 8" on center, using T12 or T8 lamps
- Always place lamps 3/4" from back of sign

Additional Information (pgs 196-197)

Note: It is recommended to use safety chains and prop-bars on all hingeable faces.

Unassembled Double Face Kits w/ Reveal - For Vandal Retainers

Medium Body w/ Inner Frame and Outer Frame

Part #2015
KMB/99/42

Part #2099

Part #1942

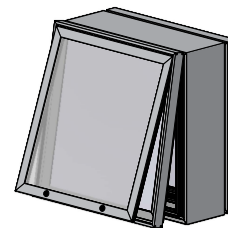
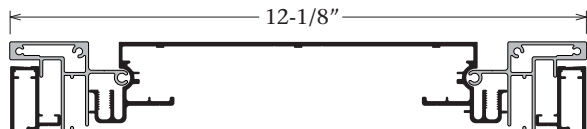

Size H'xW'	Mill Finish	Dk. Bronze	Size H'xW'	Mill Finish	Dk. Bronze	Size H'xW'	Mill Finish	Dk. Bronze	Size H'xW'	Mill Finish	Dk. Bronze
2 x 3	\$621	\$799	4 x 4	\$912	\$1192	6 x 6	\$1303	\$1742	8 x 14	\$2311	\$3079
2 x 4	725	939	4 x 5	1013	1331	6 x 7	1406	1881	8 x 15	2413	3220
2 x 5	828	1081	4 x 6	1116	1470	6 x 8	1507	2021	8 x 16	2516	3357
2 x 6	930	1218	4 x 7	1220	1608	6 x 9	1609	2160	8 x 17	2619	3496
2 x 7	1035	1358	4 x 8	1320	1744	6 x 10	1712	2302	8 x 18	2721	3636
2 x 8	1136	1495	4 x 9	1426	1885	6 x 11	1816	2444	8 x 19	2826	3773
2 x 9	1237	1635	4 x 10	1528	2023	6 x 12	1922	2584	8 x 20	2929	3911
2 x 10	1340	1772	4 x 11	1629	2160	6 x 13	2023	2725	9 x 9	1891	2511
2 x 11	1443	1910	4 x 12	1731	2298	6 x 14	2126	2865	9 x 10	1993	2650
2 x 12	1546	2049	4 x 13	1837	2441	6 x 15	2228	3006	9 x 11	2099	2788
2 x 13	1649	2190	4 x 14	1938	2575	6 x 16	2329	3145	9 x 12	2202	2928
2 x 14	1751	2328	4 x 15	2040	2718	6 x 17	2432	3285	9 x 13	2302	3066
2 x 15	1854	2468	4 x 16	2143	2856	6 x 18	2536	3427	9 x 14	2404	3205
2 x 16	1958	2604	4 x 17	2247	2995	6 x 19	2635	3566	9 x 15	2509	3343
2 x 17	2061	2745	4 x 18	2350	3133	6 x 20	2740	3708	9 x 16	2612	3482
2 x 18	2160	2882	4 x 19	2452	3270	7 x 7	1501	2005	9 x 17	2714	3620
2 x 19	2263	3023	4 x 20	2555	3410	7 x 8	1602	2144	9 x 18	2816	3759
2 x 20	2366	3159				7 x 9	1705	2287	9 x 19	2917	3899
			5 x 5	1109	1455	7 x 10	1807	2429	9 x 20	3022	4038
3 x 3	717	928	5 x 6	1208	1593	7 x 11	1909	2570	10 x 10	2089	2775
3 x 4	816	1067	5 x 7	1312	1731	7 x 12	2012	2712	10 x 11	2190	2915
3 x 5	920	1201	5 x 8	1416	1870	7 x 13	2116	2849	10 x 12	2294	3054
3 x 6	1025	1343	5 x 9	1517	2012	7 x 14	2218	2992	10 x 13	2397	3191
3 x 7	1128	1483	5 x 10	1623	2147	7 x 15	2322	3130	10 x 14	2496	3331
3 x 8	1232	1621	5 x 11	1725	2289	7 x 16	2425	3270	10 x 15	2599	3468
3 x 9	1331	1759	5 x 12	1826	2426	7 x 17	2527	3411	10 x 16	2705	3608
3 x 10	1434	1897	5 x 13	1928	2567	7 x 18	2630	3553	10 x 17	2809	3747
3 x 11	1537	2037	5 x 14	2030	2705	7 x 19	2731	3694	10 x 18	2909	3886
3 x 12	1639	2174	5 x 15	2133	2842	7 x 20	2832	3832	10 x 19	3011	4024
3 x 13	1740	2317	5 x 16	2237	2983	8 x 8	1697	2273	10 x 20	3114	4163
3 x 14	1843	2454	5 x 17	2340	3118	8 x 9	1799	2417			
3 x 15	1946	2594	5 x 18	2437	3259	8 x 10	1901	2558			
3 x 16	2049	2730	5 x 19	2547	3396	8 x 11	2002	2697			
3 x 17	2154	2870	5 x 20	2649	3537	8 x 12	2105	2838			
3 x 18	2256	3010				8 x 13	2207	2943			
3 x 19	2358	3147									
3 x 20	2460	3287									

Kits Include:

- Mill Finish or Dk. Bronze
- Cut to size and mitered bodies
- Cut to size and mitered Inner/Outer Frame Retainers
- All screws required to assemble by mechanical fastening
- All Corner Angles and/or Corner Keys required
- Cut to size 2Part Hinges
- Four (4) 2Part Locks and One (1) 2Part Lock Wrench
- Packaging

Not Included in Kits:

- Faces
- Electrical Components
- Ballast Bracket(s) - See optional accessories
- Internal Supports
- Drilling of holes for locks
- Attachment of locks and hinges
- Raceway Covers and Cover Screws - See optional accessories

Optional Accessories (pg 127):

- Ballast Bracket(s)
- Raceway Covers and Cover Screws

Kit Specifications:

- It is recommended to order kits 1" over nominal T12 or T8 lamp size to utilize .040 flat Aluminum Raceway Covers
- Custom size kits may be cut to any dimension
- Vandal Retainer is not designed to be used with SignComp Gas Supports

Recommended Lamp Spacing:

- For illuminated backgrounds - 6" on center, using T12 or T8 lamps

Additional Information (pgs 196-197)

Note: It is recommended to use safety chains and prop-bars on all hingeable faces.

Note: All dimensions are subject to the tolerance standards of the aluminum extrusion industry. Profile drawings are illustrative and rounded to the nearest 1/16".

CURRENT PRICE as of April 1, 2022



COMMERCIAL

Unassembled Double Face Kits w/ Reveal - For Vandal Retainers

Wide Body w/ Inner Frame and Outer Frame

Part #2005
KWB/99/42

Part #2099

Part #1942

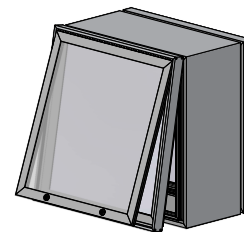
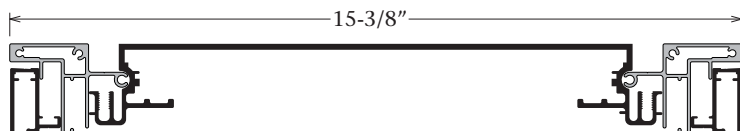

Size H'xW'	Mill Finish	Dk. Bronze	Size H'xW'	Mill Finish	Dk. Bronze	Size H'xW'	Mill Finish	Dk. Bronze	Size H'xW'	Mill Finish	Dk. Bronze
2 x 3	\$699	\$908	4 x 4	\$1038	\$1363	6 x 6	\$1493	\$1980	8 x 14	\$2658	\$3555
2 x 4	820	1070	4 x 5	1157	1526	6 x 7	1609	2139	8 x 15	2777	3715
2 x 5	936	1228	4 x 6	1272	1686	6 x 8	1730	2297	8 x 16	2895	3874
2 x 6	1055	1388	4 x 7	1394	1843	6 x 9	1846	2458	8 x 17	3011	4036
2 x 7	1174	1554	4 x 8	1510	2008	6 x 10	1966	2619	8 x 18	3133	4195
2 x 8	1291	1714	4 x 9	1630	2167	6 x 11	2087	2781	8 x 19	3253	4357
2 x 9	1410	1870	4 x 10	1746	2325	6 x 12	2200	2937	8 x 20	3371	4515
2 x 10	1528	2032	4 x 11	1865	2483	6 x 13	2322	3103	9 x 9	2174	2900
2 x 11	1649	2195	4 x 12	1986	2647	6 x 14	2442	3261	9 x 10	2294	3061
2 x 12	1767	2353	4 x 13	2103	2812	6 x 15	2556	3420	9 x 11	2414	3217
2 x 13	1886	2511	4 x 14	2222	2967	6 x 16	2675	3582	9 x 12	2531	3383
2 x 14	2001	2675	4 x 15	2338	3131	6 x 17	2796	3741	9 x 13	2647	3542
2 x 15	2124	2832	4 x 16	2460	3288	6 x 18	2915	3901	9 x 14	2768	3701
2 x 16	2238	2994	4 x 17	2579	3448	6 x 19	3031	4062	9 x 15	2885	3862
2 x 17	2357	3159	4 x 18	2694	3609	6 x 20	3152	4223	9 x 16	3006	4022
2 x 18	2479	3315	4 x 19	2813	3771	7 x 7	1719	2286	9 x 17	3122	4179
2 x 19	2596	3475	4 x 20	2936	3929	7 x 8	1838	2445	9 x 18	3241	4343
2 x 20	2717	3634				7 x 9	1958	2607	9 x 19	3361	4505
			5 x 5	1265	1672	7 x 10	2075	2768	9 x 20	3480	4662
3 x 3	811	1057	5 x 6	1382	1831	7 x 11	2195	2928	10 x 10	2402	3206
3 x 4	928	1220	5 x 7	1500	1993	7 x 12	3211	3087	10 x 11	2521	3368
3 x 5	1043	1376	5 x 8	1623	2152	7 x 13	2430	3245	10 x 12	2640	3526
3 x 6	1165	1537	5 x 9	1739	2313	7 x 14	2549	3408	10 x 13	2756	3687
3 x 7	1285	1699	5 x 10	1855	2475	7 x 15	2666	3570	10 x 14	2877	3847
3 x 8	1402	1859	5 x 11	1973	2633	7 x 16	2785	3727	10 x 15	2995	4006
3 x 9	1518	2018	5 x 12	2095	2794	7 x 17	2905	3889	10 x 16	3113	4171
3 x 10	1639	2179	5 x 13	2215	2954	7 x 18	3024	4049	10 x 17	3232	4329
3 x 11	1759	2341	5 x 14	2329	3114	7 x 19	3142	4207	10 x 18	3348	4488
3 x 12	1875	2501	5 x 15	2449	3270	7 x 20	3261	4371	10 x 19	3470	4650
3 x 13	1993	2661	5 x 16	2568	3436	8 x 8	1945	2592	10 x 20	3590	4811
3 x 14	2114	2819	5 x 17	2687	3597	8 x 9	2067	2753			
3 x 15	2231	2982	5 x 18	2802	3752	8 x 10	2186	2915			
3 x 16	2350	3142	5 x 19	2923	3917	8 x 11	2302	3075			
3 x 17	2467	3299	5 x 20	3046	4080	8 x 12	2420	3234			
3 x 18	2586	3464				8 x 13	2542	3392			
3 x 19	2705	3622									
3 x 20	2826	3780									

Kits Include:

- Mill Finish or Dk. Bronze
- Cut to size and mitered bodies
- Cut to size and mitered Inner/Outer Frame Retainers
- All screws required to assemble by mechanical fastening
- All Corner Angles and/or Corner Keys required
- Cut to size 2Part Hinges
- Four (4) 2Part Locks and One (1) 2Part Lock Wrench
- Packaging

Not Included in Kits:

- Faces
- Electrical Components
- Ballast Bracket(s) - See optional accessories
- Internal Supports
- Drilling of holes for locks
- Attachment of locks and hinges
- Raceway Covers and Cover Screws - See optional accessories

Optional Accessories (pg 127):

- Ballast Bracket(s)
- Raceway Covers and Cover Screws

Kit Specifications:

- It is recommended to order kits 1" over nominal T12 or T8 lamp size to utilize .040 flat Aluminum Raceway Covers
- Custom size kits may be cut to any dimension
- Vandal Retainer is not designed to be used with SignComp Gas Supports

Recommended Lamp Spacing:

- For illuminated backgrounds - 10" on center, using T12 or T8 lamps

Additional Information (pgs 196-197)

Note: It is recommended to use safety chains and prop-bars on all hingeable faces.

Unassembled Retro Kits w/ Reveal - For Vandal Retainers

Retro Body w/ Large Inner Frame and Large Outer Frame

Part #2040
K2040/97/41

Part #2097

Part #1941

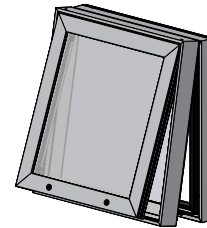
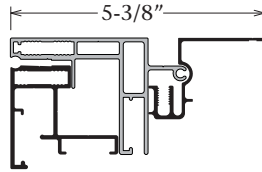

Size H'xW'	Mill Finish	Size H'xW'	Mill Finish	Size H'xW'	Mill Finish	Size H'xW'	Mill Finish
2 x 3	381	4 x 4	\$564	6 x 6	\$811	8 x 14	\$1447
2 x 4	444	4 x 5	627	6 x 7	880	8 x 15	1513
2 x 5	508	4 x 6	694	6 x 8	942	8 x 16	1574
2 x 6	574	4 x 7	756	6 x 9	1007	8 x 17	1640
2 x 7	639	4 x 8	821	6 x 10	1071	8 x 18	1707
2 x 8	701	4 x 9	887	6 x 11	1134	8 x 19	1770
2 x 9	768	4 x 10	950	6 x 12	1199	8 x 20	1834
2 x 10	832	4 x 11	1014	6 x 13	1263		
2 x 11	897	4 x 12	1081	6 x 14	1327	9 x 9	1186
2 x 12	959	4 x 13	1146	6 x 15	1394	9 x 10	1251
2 x 13	1026	4 x 14	1208	6 x 16	1454	9 x 11	1315
2 x 14	1088	4 x 15	1275	6 x 17	1523	9 x 12	1378
2 x 15	1153	4 x 16	1336	6 x 18	1586	9 x 13	1442
2 x 16	1220	4 x 17	1400	6 x 19	1649	9 x 14	1507
2 x 17	1283	4 x 18	1467	6 x 20	1714	9 x 15	1572
2 x 18	1346	4 x 19	1530			9 x 16	1637
2 x 19	1413	4 x 20	1593	7 x 7	938	9 x 17	1699
2 x 20	1473			7 x 8	1002	9 x 18	1764
		5 x 5	689	7 x 9	1063	9 x 19	1831
3 x 3	441	5 x 6	753	7 x 10	1132	9 x 20	1893
3 x 4	506	5 x 7	816	7 x 11	1193		
3 x 5	567	5 x 8	883	7 x 12	1259	10 x 10	1306
3 x 6	637	5 x 9	944	7 x 13	1324	10 x 11	1375
3 x 7	698	5 x 10	1011	7 x 14	1388	10 x 12	1438
3 x 8	765	5 x 11	1077	7 x 15	1451	10 x 13	1501
3 x 9	828	5 x 12	1138	7 x 16	1517	10 x 14	1569
3 x 10	890	5 x 13	1202	7 x 17	1581	10 x 15	1632
3 x 11	956	5 x 14	1269	7 x 18	1644	10 x 16	1695
3 x 12	1019	5 x 15	1331	7 x 19	1711	10 x 17	1760
3 x 13	1085	5 x 16	1397	7 x 20	1775	10 x 18	1826
3 x 14	1149	5 x 17	1462			10 x 19	1889
3 x 15	1212	5 x 18	1526	8 x 8	1060	10 x 20	1953
3 x 16	1279	5 x 19	1589	8 x 9	1128		
3 x 17	1343	5 x 20	1657	8 x 10	1190		
3 x 18	1406			8 x 11	1253		
3 x 19	1470			8 x 12	1319		
3 x 20	1534			8 x 13	1382		

Kits Include:

- Mill Finish
- Cut to size and mitered bodies
- Cut to size and mitered Lg Inner/Lg Outer Frame Retainers
- All screws required to assemble by mechanical fastening
- All Corner Angles and/or Corner Keys required
- Cut to size 2Part Large Hinge
- Two (2) 2Part Large Locks
- Packaging
- Prices reflect one (1) Retro Body kit, SINGLE FACE APPLICATION

Not Included in Kits:

- Faces
- Electrical Components
- Drilling of holes for locks
- Attachment of locks and hinge
- Gas Supports and Mounting Hardware - See optional accessories
- Mounting Provisions

Optional Accessories (pg 128):

- Gas Supports and Mounting Hardware (Call Customer Service for size and price)

Kit Specifications:

- Kits will be cut .265" larger to fit over existing structure
- Custom size kits may be cut to any dimension
- Illumination may vary depending on application

Additional Information (pgs 196-197)

Note: It is recommended to use safety chains and prop-bars on all hingeable faces.

Note: All dimensions are subject to the tolerance standards of the aluminum extrusion industry. Profile drawings are illustrative and rounded to the nearest 1/16".

CURRENT PRICE as of April 1, 2022



COMMERCIAL

Unassembled Single Face Kits w/ Reveal - For Vandal Retainers

Slimline Single Face Body w/ Large Inner Frame and Large Outer Frame

Part #2020
K2020/97/41

Part #2097

Part #1941

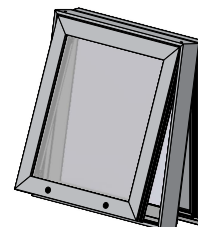
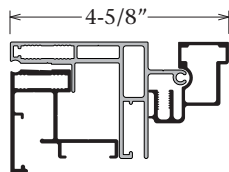

Size H'xW'	Mill Finish	Dk. Bronze	Size H'xW'	Mill Finish	Dk. Bronze	Size H'xW'	Mill Finish	Dk. Bronze	Size H'xW'	Mill Finish	Dk. Bronze
2 x 3	\$393	\$511	4 x 4	\$586	\$769	6 x 6	844	\$1117	8 x 14	\$1505	\$2009
2 x 4	460	601	4 x 5	651	862	6 x 7	914	1211	8 x 15	1574	2100
2 x 5	526	694	4 x 6	721	951	6 x 8	979	1299	8 x 16	1637	2194
2 x 6	595	784	4 x 7	784	1041	6 x 9	1045	1391	8 x 17	1708	2279
2 x 7	662	874	4 x 8	853	1132	6 x 10	1116	1482	8 x 18	1776	2372
2 x 8	728	964	4 x 9	922	1221	6 x 11	1180	1573	8 x 19	1841	2464
2 x 9	796	1053	4 x 10	987	1315	6 x 12	1248	1661	8 x 20	1909	2555
2 x 10	865	1145	4 x 11	1054	1404	6 x 13	1312	1752	9 x 9	1235	1641
2 x 11	931	1239	4 x 12	1122	1494	6 x 14	1379	1843	9 x 10	1300	1730
2 x 12	995	1327	4 x 13	1192	1584	6 x 15	1450	1933	9 x 11	1367	1823
2 x 13	1065	1419	4 x 14	1255	1676	6 x 16	1513	2023	9 x 12	1367	1823
2 x 14	1132	1509	4 x 15	1325	1762	6 x 17	1584	2116	9 x 13	1434	1914
2 x 15	1197	1598	4 x 16	1390	1858	6 x 18	1651	2206	9 x 14	1501	2001
2 x 16	1268	1688	4 x 17	1455	1948	6 x 19	1715	2294	9 x 15	1569	2095
2 x 17	1331	1779	4 x 18	1526	2037	6 x 20	1784	2386	9 x 16	1635	2184
2 x 18	1398	1870	4 x 19	1590	2128	7 x 7	976	1293	9 x 17	1705	2275
2 x 19	1469	1961	4 x 20	1656	2218	7 x 8	1039	1381	9 x 18	1768	2365
2 x 20	1532	2051				7 x 9	1106	1473	9 x 19	1837	2457
			5 x 5	716	944	7 x 10	1176	1562	9 x 20	1906	2544
3 x 3	457	597	5 x 6	781	1035	7 x 11	1241	1656		1969	2638
3 x 4	523	688	5 x 7	849	1128	7 x 12	1309	1746	10 x 10	1360	1816
3 x 5	590	776	5 x 8	916	1217	7 x 13	1376	1835	10 x 11	1431	1906
3 x 6	658	867	5 x 9	982	1303	7 x 14	1443	1928	10 x 12	1497	1997
3 x 7	724	959	5 x 10	1051	1397	7 x 15	1510	2016	10 x 13	1561	2089
3 x 8	793	1046	5 x 11	1120	1488	7 x 16	1577	2105	10 x 14	1632	2179
3 x 9	860	1141	5 x 12	1184	1578	7 x 17	1647	2200	10 x 15	1699	2265
3 x 10	924	1233	5 x 13	1251	1671	7 x 18	1711	2289	10 x 16	1764	2358
3 x 11	992	1319	5 x 14	1319	1758	7 x 19	1782	2380	10 x 17	1833	2449
3 x 12	1058	1409	5 x 15	1384	1850	7 x 20	1846	2470	10 x 18	1900	2540
3 x 13	1129	1502	5 x 16	1453	1940	8 x 8	1104	1466	10 x 19	1965	2633
3 x 14	1195	1590	5 x 17	1522	2029	8 x 9	1172	1557	10 x 20	2035	2719
3 x 15	1260	1681	5 x 18	1586	2123	8 x 10	1239	1649			
3 x 16	1328	1775	5 x 19	1653	2212	8 x 11	1303	1736			
3 x 17	1395	1862	5 x 20	1725	2303	8 x 12	1372	1830			
3 x 18	1462	1953				8 x 13	1439	1921			
3 x 19	1529	2044									
3 x 20	1596	2133									

Kits Include:

- Mill Finish or Dk. Bronze
- Cut to size and mitered bodies
- Cut to size and mitered Lg Inner/Lg Outer Frame Retainers
- All screws required to assemble by mechanical fastening
- All Corner Angles and/or Corner Keys required
- Cut to size 2Part Large Hinge
- Two (2) 2Part Large Locks
- Packaging

Not Included in Kits:

- Faces or Back
- Electrical Components
- Back Braces and Gussets
- Drilling of holes for locks
- Attachment of locks and hinge
- Gas Supports and Mounting Hardware - See optional accessories
- Mounting Provisions

Optional Accessories (pg 128):

- Gas Supports and Mounting Hardware (Call Customer Service for size and price)

Kit Specifications:

- Recommended for LED applications
- Custom size kits may be cut to any dimension

Additional Information (pgs 196-197)

Note: It is recommended to use safety chains and prop-bars on all hingeable faces.

Unassembled Single Face Kits w/ Reveal - For Vandal Retainers

Narrow Single Face Body w/ Large Inner Frame and Large Outer Frame

Part #2021
K2021/97/41

Part #2097

Part #1941

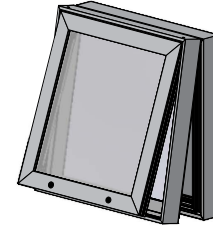
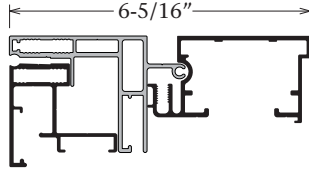

Size H'xW'	Mill Finish	Dk. Bronze	Size H'xW'	Mill Finish	Dk. Bronze	Size H'xW'	Mill Finish	Dk. Bronze	Size H'xW'	Mill Finish	Dk. Bronze
2 x 3	\$423	\$551	4 x 4	\$631	\$835	6 x 6	\$914	\$1216	8 x 14	\$1635	\$2190
2 x 4	495	651	4 x 5	704	935	6 x 7	990	1316	8 x 15	1709	2289
2 x 5	567	752	4 x 6	780	1034	6 x 8	1061	1415	8 x 16	1779	2388
2 x 6	642	851	4 x 7	851	1132	6 x 9	1134	1513	8 x 17	1855	2485
2 x 7	716	947	4 x 8	923	1228	6 x 10	1209	1612	8 x 18	1930	2584
2 x 8	785	1046	4 x 9	998	1327	6 x 11	1279	1711	8 x 19	2001	2686
2 x 9	860	1142	4 x 10	1069	1430	6 x 12	1354	1809	8 x 20	2075	2782
2 x 10	935	1243	4 x 11	1142	1528	6 x 13	1423	1907	9 x 9	1340	1790
2 x 11	1007	1344	4 x 12	1217	1624	6 x 14	1498	2005	9 x 10	1413	1885
2 x 12	1079	1442	4 x 13	1291	1721	6 x 15	1573	2104	9 x 11	1485	1988
2 x 13	1153	1542	4 x 14	1362	1822	6 x 16	1641	2203	9 x 12	1557	2087
2 x 14	1224	1639	4 x 15	1438	1917	6 x 17	1718	2305	9 x 13	1630	2182
2 x 15	1297	1736	4 x 16	1507	2020	6 x 18	1791	2402	9 x 14	1703	2282
2 x 16	1374	1837	4 x 17	1578	2120	6 x 19	1863	2497	9 x 15	1776	2381
2 x 17	1443	1935	4 x 18	1655	2218	6 x 20	1938	2599	9 x 16	1853	2480
2 x 18	1517	2035	4 x 19	1727	2317	7 x 7	1058	1407	9 x 17	1922	2579
2 x 19	1590	2131	4 x 20	1798	2413	7 x 8	1129	1504	9 x 18	1997	2677
2 x 20	1661	2231				7 x 9	1199	1604	9 x 19	2072	2773
			5 x 5	774	1027	7 x 10	1275	1702	9 x 20	2142	2875
3 x 3	492	646	5 x 6	847	1125	7 x 11	1347	1804	10 x 10	1478	1980
3 x 4	564	745	5 x 7	918	1224	7 x 12	1421	1901	10 x 11	1554	2076
3 x 5	637	840	5 x 8	992	1323	7 x 13	1495	1998	10 x 12	1625	2176
3 x 6	710	939	5 x 9	1065	1419	7 x 14	1565	2099	10 x 13	1697	2277
3 x 7	783	1041	5 x 10	1138	1520	7 x 15	1639	2196	10 x 14	1772	2374
3 x 8	857	1137	5 x 11	1213	1620	7 x 16	1712	2294	10 x 15	1846	2470
3 x 9	931	1239	5 x 12	1284	1716	7 x 17	1787	2397	10 x 16	1919	2571
3 x 10	1002	1339	5 x 13	1356	1818	7 x 18	1859	2493	10 x 17	1992	2670
3 x 11	1076	1434	5 x 14	1431	1913	7 x 19	1935	2592	10 x 18	2067	2769
3 x 12	1146	1532	5 x 15	1502	2014	7 x 20	2005	2691	10 x 19	2137	2870
3 x 13	1221	1633	5 x 16	1576	2109	8 x 8	1196	1596	10 x 20	2211	2964
3 x 14	1295	1730	5 x 17	1651	2210	8 x 9	1271	1695			
3 x 15	1366	1830	5 x 18	1721	2310	8 x 10	1344	1795			
3 x 16	1441	1930	5 x 19	1794	2409	8 x 11	1416	1891			
3 x 17	1513	2024	5 x 20	1871	2508	8 x 12	1491	1992			
3 x 18	1585	2124				8 x 13	1561	2092			
3 x 19	1657	2223									
3 x 20	1731	2322									

Kits Include:

- Mill Finish or Dk. Bronze
- Cut to size and mitered bodies
- Cut to size and mitered Lg Inner/Lg Outer Frame Retainers
- All screws required to assemble by mechanical fastening
- All Corner Angles and/or Corner Keys required
- Cut to size 2Part Large Hinge
- Two (2) 2Part Large Locks
- Packaging

Not Included in Kits:

- Faces or Back
- Electrical Components
- Back Braces and Gussets
- Drilling of holes for locks
- Attachment of locks and hinge
- Gas Supports and Mounting Hardware - See optional accessories
- Mounting Provisions

Optional Accessories (pg 128):

- Gas Supports and Mounting Hardware (Call Customer Service for size and price)

Kit Specifications:

- Recommended for LED applications
- Custom size kits may be cut to any dimension

Additional Information (pgs 196-197)

Note: It is recommended to use safety chains and prop-bars on all hingeable faces.

Note: All dimensions are subject to the tolerance standards of the aluminum extrusion industry. Profile drawings are illustrative and rounded to the nearest 1/16".

CURRENT PRICE as of April 1, 2022



COMMERCIAL

Unassembled Single Face Kits w/ Reveal - For Vandal Retainers

Single Face Body w/ Large Inner Frame and Large Outer Frame

Part #2025
KSF/97/41

Part #2097

Part #1941

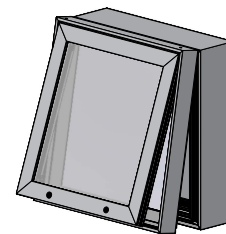
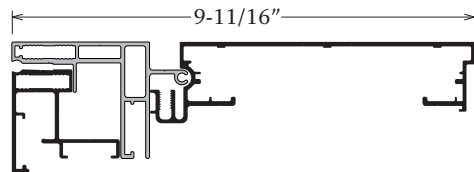

Size H'xW'	Mill Finish	Dk. Bronze	Size H'xW'	Mill Finish	Dk. Bronze	Size H'xW'	Mill Finish	Dk. Bronze	Size H'xW'	Mill Finish	Dk. Bronze
2 x 3	\$439	\$574	4 x 4	\$657	\$869	6 x 6	\$951	\$1267	8 x 14	\$1703	\$2282
2 x 4	515	676	4 x 5	732	975	6 x 7	1030	1372	8 x 15	1782	2386
2 x 5	590	781	4 x 6	811	1076	6 x 8	1105	1473	8 x 16	1854	2491
2 x 6	667	884	4 x 7	884	1177	6 x 9	1181	1577	8 x 17	1932	2590
2 x 7	744	985	4 x 8	960	1280	6 x 10	1259	1681	8 x 18	2009	2694
2 x 8	817	1089	4 x 9	1038	1382	6 x 11	1331	1784	8 x 19	2083	2800
2 x 9	896	1189	4 x 10	1113	1488	6 x 12	1409	1885	8 x 20	2159	2903
2 x 10	974	1295	4 x 11	1189	1590	6 x 13	1482	1988	9 x 9	1395	1866
2 x 11	1046	1400	4 x 12	1267	1692	6 x 14	1560	2092	9 x 10	1471	1966
2 x 12	1121	1501	4 x 13	1344	1794	6 x 15	1637	2195	9 x 11	1548	2073
2 x 13	1199	1605	4 x 14	1418	1898	6 x 16	1711	2297	9 x 12	1623	2175
2 x 14	1274	1708	4 x 15	1497	1998	6 x 17	1790	2402	9 x 13	1699	2275
2 x 15	1350	1809	4 x 16	1570	2105	6 x 18	1866	2505	9 x 14	1775	2381
2 x 16	1430	1913	4 x 17	1644	2210	6 x 19	1940	2604	9 x 15	1850	2483
2 x 17	1502	2016	4 x 18	1724	2310	6 x 20	2017	2710	9 x 16	1928	2586
2 x 18	1578	2120	4 x 19	1798	2414	7 x 7	1102	1467	9 x 17	2001	2689
2 x 19	1656	2222	4 x 20	1871	2516	7 x 8	1174	1569	9 x 18	2079	2793
2 x 20	1730	2325				7 x 9	1249	1672	9 x 19	2156	2893
			5 x 5	805	1069	7 x 10	1328	1775	9 x 20	2230	2998
3 x 3	511	671	5 x 6	881	1172	7 x 11	1403	1881	10 x 10	1540	2065
3 x 4	586	774	5 x 7	956	1275	7 x 12	1479	1984	10 x 11	1620	2167
3 x 5	661	875	5 x 8	1034	1378	7 x 13	1557	2083	10 x 12	1693	2271
3 x 6	740	979	5 x 9	1109	1478	7 x 14	1632	2190	10 x 13	1768	2374
3 x 7	813	1083	5 x 10	1186	1584	7 x 15	1708	2289	10 x 14	1847	2477
3 x 8	891	1184	5 x 11	1264	1687	7 x 16	1784	2390	10 x 15	1922	2575
3 x 9	967	1290	5 x 12	1336	1790	7 x 17	1862	2497	10 x 16	1998	2682
3 x 10	1041	1394	5 x 13	1413	1894	7 x 18	1935	2599	10 x 17	2075	2785
3 x 11	1118	1494	5 x 14	1491	1993	7 x 19	2014	2702	10 x 18	2152	2889
3 x 12	1193	1596	5 x 15	1564	2099	7 x 20	2089	2806	10 x 19	2226	2994
3 x 13	1271	1702	5 x 16	1640	2200	8 x 8	1247	1664	10 x 20	2303	3091
3 x 14	1347	1803	5 x 17	1718	2303	8 x 9	1324	1768			
3 x 15	1422	1906	5 x 18	1793	2409	8 x 10	1400	1871			
3 x 16	1500	2012	5 x 19	1869	2511	8 x 11	1474	1972			
3 x 17	1576	2109	5 x 20	1948	2614	8 x 12	1553	2077			
3 x 18	1651	2215				8 x 13	1627	2182			
3 x 19	1727	2317									
3 x 20	1803	2419									

Kits Include:

- Mill Finish or Dk. Bronze
- Cut to size and mitered bodies
- Cut to size and mitered Lg Inner/Lg Outer Frame Retainers
- All screws required to assemble by mechanical fastening
- All Corner Angles and/or Corner Keys required
- Cut to size 2Part Large Hinge
- Two (2) 2Part Large Locks
- Packaging

Not Included in Kits:

- Faces or Back
- Electrical Components
- Ballast Bracket(s) - See optional accessories
- Back Braces and Gussets
- Drilling of holes for locks
- Attachment of locks and hinge
- Raceway Covers and Cover Screws - See optional accessories
- Gas Supports and Mounting Hardware - See optional accessories
- Mounting Provisions

Optional Accessories (pgs 127-128):

- Ballast Bracket(s)
- Raceway Covers and Cover Screws
- Gas Supports and Mounting Hardware (Call Customer Service for size and price)

Kit Specifications:

- It is recommended to order kits 1" over nominal T12 or T8 lamp size to utilize .040 flat Aluminum Raceway Covers
- Custom size kits may be cut to any dimension

Recommended Lamp Spacing:

- For illuminated backgrounds - 8" on center, using T12 or T8 lamps
- Always place lamps 3/4" from back of sign

Additional Information (pgs 196-197)

Note: It is recommended to use safety chains and prop-bars on all hingeable faces.

Unassembled Double Face Kits w/ Reveal - For Vandal Retainers

Medium Body w/ Large Inner Frame and Large Outer Frame

Part #2015
KMB/97/41

Part #2097

Part #1941

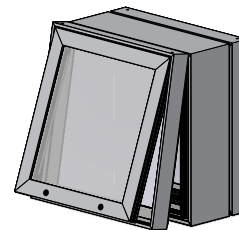
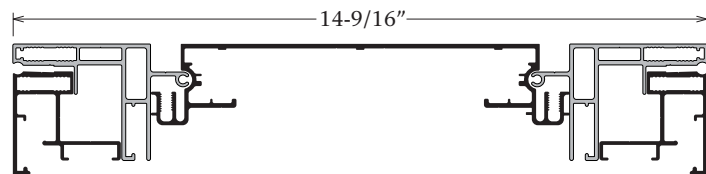

Size H'xW'	Mill Finish	Dk. Bronze	Size H'xW'	Mill Finish	Dk. Bronze	Size H'xW'	Mill Finish	Dk. Bronze	Size H'xW'	Mill Finish	Dk. Bronze
2 x 3	\$781	\$1019	4 x 4	\$1170	\$1546	6 x 6	\$1691	\$2273	8 x 14	\$3022	\$4052
2 x 4	918	1207	4 x 5	1302	1730	6 x 7	1823	2456	8 x 15	3154	4236
2 x 5	1054	1390	4 x 6	1438	1911	6 x 8	1958	2640	8 x 16	3288	4418
2 x 6	1188	1573	4 x 7	1574	2095	6 x 9	2093	2825	8 x 17	3424	4601
2 x 7	1324	1756	4 x 8	1708	2275	6 x 10	2228	3008	8 x 18	3558	4785
2 x 8	1457	1937	4 x 9	1844	2460	6 x 11	2363	3194	8 x 19	3696	4967
2 x 9	1590	2121	4 x 10	1977	2642	6 x 12	2503	3380	8 x 20	3831	5148
2 x 10	1727	2303	4 x 11	2112	2825	6 x 13	2635	3565	9 x 9	2470	3307
2 x 11	1862	2485	4 x 12	2247	3006	6 x 14	2769	3749	9 x 10	2607	3490
2 x 12	1997	2668	4 x 13	2384	3191	6 x 15	2904	3933	9 x 11	2742	3672
2 x 13	2131	2853	4 x 14	2517	3372	6 x 16	3038	4117	9 x 12	2877	3855
2 x 14	2265	3035	4 x 15	2651	3557	6 x 17	3174	4301	9 x 13	3010	4038
2 x 15	2401	3220	4 x 16	2786	3740	6 x 18	3308	4489	9 x 14	3145	4220
2 x 16	2537	3399	4 x 17	2923	3922	6 x 19	3440	4671	9 x 15	3282	4403
2 x 17	2673	3582	4 x 18	3058	4106	6 x 20	3577	4857	9 x 16	3417	4587
2 x 18	2804	3766	4 x 19	3193	4287	7 x 7	1951	2624	9 x 17	3550	4767
2 x 19	2940	3950	4 x 20	3327	4472	7 x 8	2087	2808	9 x 18	3684	4952
2 x 20	3075	4132				7 x 9	2221	2995	9 x 19	3817	5135
			5 x 5	1430	1897	7 x 10	2354	3180	9 x 20	3955	5320
			5 x 6	1561	2079	7 x 11	2488	3366			
			5 x 7	1699	2261	7 x 12	2623	3550	10 x 10	2731	3659
			5 x 8	1834	2445	7 x 13	2761	3733	10 x 11	2865	3840
			5 x 9	1968	2630	7 x 14	2893	3918	10 x 12	3002	4025
			5 x 10	2105	2812	7 x 15	3030	4101	10 x 13	3137	4207
			5 x 11	2242	2996	7 x 16	3165	4287	10 x 14	3269	4392
			5 x 12	2373	3177	7 x 17	3299	4473	10 x 15	3404	4573
			5 x 13	2508	3363	7 x 18	3435	4659	10 x 16	3543	4757
			5 x 14	2643	3545	7 x 19	3570	4842	10 x 17	3678	4940
			5 x 15	2777	3727	7 x 20	3701	5025	10 x 18	3811	5123
			5 x 16	2915	3911	8 x 8	2212	2979	10 x 19	3945	5306
			5 x 17	3050	4092	8 x 9	2347	3168	10 x 20	4081	5488
			5 x 18	3180	4275	8 x 10	2481	3352			
			5 x 19	3319	4458	8 x 11	2615	3537			
			5 x 20	3454	4641	8 x 12	2749	3721			
						8 x 13	2884	3868			

Kits Include:

- Mill Finish or Dk. Bronze
- Cut to size and mitered bodies
- Cut to size and mitered Lg Inner/Lg Outer Frame Retainers
- All screws required to assemble by mechanical fastening
- All Corner Angles and/or Corner Keys required
- Cut to size 2Part Large Hinges
- Four (4) 2Part Large Locks
- Packaging

Not Included in Kits:

- Faces
- Electrical Components
- Ballast Bracket(s) - See optional accessories
- Internal Supports
- Drilling of holes for locks
- Attachment of locks and hinges
- Raceway Covers and Cover Screws - See optional accessories
- Gas Supports and Mounting Hardware - See optional accessories

Optional Accessories (pgs 127-128):

- Ballast Bracket(s)
- Raceway Covers and Cover Screws
- Gas Supports and Mounting Hardware (Call Customer Service for size and price)

Kit Specifications:

- It is recommended to order kits 1" over nominal T12 or T8 lamp size to utilize .040 flat Aluminum Raceway Covers
- Custom size kits may be cut to any dimension

Recommended Lamp Spacing:

- For illuminated backgrounds - 6" on center, using T12 or T8 lamps

Additional Information (pgs 196-197)

Note: It is recommended to use safety chains and prop-bars on all hingeable faces.

Note: All dimensions are subject to the tolerance standards of the aluminum extrusion industry. Profile drawings are illustrative and rounded to the nearest 1/16".

CURRENT PRICE as of April 1, 2022



COMMERCIAL

Unassembled Double Face Kits w/ Reveal - For Vandal Retainers

Wide Body w/ Large Inner Frame and Large Outer Frame

Part #2005
KWB/97/41

Part #2097

Part #1941

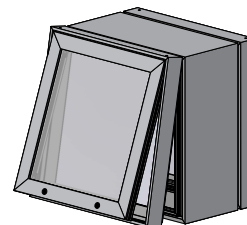
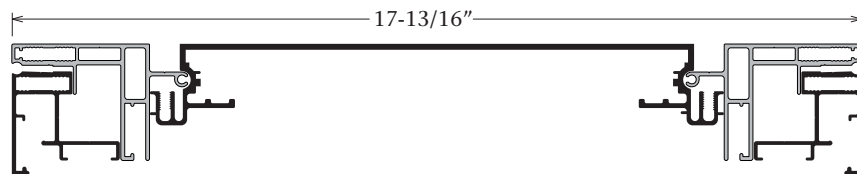

Size H'xW'	Mill Finish	Dk. Bronze	Size H'xW'	Mill Finish	Dk. Bronze	Size H'xW'	Mill Finish	Dk. Bronze	Size H'xW'	Mill Finish	Dk. Bronze
2 x 3	\$860	\$1130	4 x 4	\$1296	\$1716	6 x 6	\$1879	\$2509	8 x 14	\$3366	\$4528
2 x 4	1011	1336	4 x 5	1446	1923	6 x 7	2028	2714	8 x 15	3518	4732
2 x 5	1162	1538	4 x 6	1595	2127	6 x 8	2180	2916	8 x 16	3668	4936
2 x 6	1314	1742	4 x 7	1748	2329	6 x 9	2329	3122	8 x 17	3816	5139
2 x 7	1465	1951	4 x 8	1897	2537	6 x 10	2481	3327	8 x 18	3970	5344
2 x 8	1612	2155	4 x 9	2048	2741	6 x 11	2633	3531	8 x 19	4121	5550
2 x 9	1764	2357	4 x 10	2198	2944	6 x 12	2780	3733	8 x 20	4271	5752
2 x 10	1914	2563	4 x 11	2349	3147	6 x 13	2933	3942	9 x 9	2753	3696
2 x 11	2067	2769	4 x 12	2503	3356	6 x 14	3086	4145	9 x 10	2905	3901
2 x 12	2218	2971	4 x 13	2649	3562	6 x 15	3232	4347	9 x 11	3058	4101
2 x 13	2370	3175	4 x 14	2801	3761	6 x 16	3384	4556	9 x 12	3206	4310
2 x 14	2517	3383	4 x 15	2951	3970	6 x 17	3537	4758	9 x 13	3357	4513
2 x 15	2671	3582	4 x 16	3103	4172	6 x 18	3685	4962	9 x 14	3507	4718
2 x 16	2819	3788	4 x 17	3254	4375	6 x 19	3836	5167	9 x 15	3657	4922
2 x 17	2970	3998	4 x 18	3403	4583	6 x 20	3989	5371	9 x 16	3810	5127
2 x 18	3122	4199	4 x 19	3553	4786	7 x 7	2171	2904	9 x 17	3959	5329
2 x 19	3272	4403	4 x 20	3709	4989	7 x 8	2322	3109	9 x 18	4110	5536
2 x 20	3424	4607				7 x 9	2475	3313	9 x 19	4263	5742
			5 x 5	1586	2114	7 x 10	2622	3518	9 x 20	4414	5944
			5 x 6	1737	2317	7 x 11	2773	3724			
			5 x 7	1886	2523	7 x 12	2924	3927			
			5 x 8	2040	2726	7 x 13	3074	4129	10 x 10	3046	4090
			5 x 9	2190	2932	7 x 14	3226	4335	10 x 11	3197	4296
			5 x 10	2338	3137	7 x 15	3375	4541	10 x 12	3348	4499
			5 x 11	2489	3339	7 x 16	3526	4742	10 x 13	3498	4704
			5 x 12	2642	3545	7 x 17	3678	4950	10 x 14	3650	4906
			5 x 13	2794	3749	7 x 18	3828	5154	10 x 15	3800	5110
			5 x 14	2943	3954	7 x 19	3980	5356	10 x 16	3950	5318
			5 x 15	3091	4155	7 x 20	4129	5565	10 x 17	4100	5522
			5 x 16	3244	4362	8 x 8	2461	3299	10 x 18	4250	5725
			5 x 17	3395	4569	8 x 9	2614	3503	10 x 19	4403	5931
			5 x 18	3545	4769	8 x 10	2766	3709	10 x 20	4556	6136
			5 x 19	3696	4979	8 x 11	2915	3914			
			5 x 20	3851	5183	8 x 12	3063	4117			
						8 x 13	3217	4320			

Kits Include:

- Mill Finish or Dk. Bronze
- Cut to size and mitered bodies
- Cut to size and mitered Lg Inner/Lg Outer Frame Retainers
- All screws required to assemble by mechanical fastening
- All Corner Angles and/or Corner Keys required
- Cut to size 2Part Large Hinges
- Four (4) 2Part Large Locks
- Packaging

Not Included in Kits:

- Faces
- Electrical Components
- Ballast Bracket(s) - See optional accessories
- Internal Supports
- Drilling of holes for locks
- Attachment of locks and hinges
- Raceway Covers and Cover Screws - See optional accessories
- Gas Supports and Mounting Hardware - See optional accessories

Optional Accessories (pgs 127-128):

- Ballast Bracket(s)
- Raceway Covers and Cover Screws
- Gas Supports and Mounting Hardware (Call Customer Service for size and price)

Kit Specifications:

- It is recommended to order kits 1" over nominal T12 or T8 lamp size to utilize .040 flat Aluminum Raceway Covers
- Custom size kits may be cut to any dimension

Recommended Lamp Spacing:

- For illuminated backgrounds - 10" on center, using T12 or T8 lamps

Additional Information (pgs 196-197)

Note: It is recommended to use safety chains and prop-bars on all hingeable faces.

Unassembled Single Face Kits w/out Reveal - For Rigid Faces

Flat Wall Mount Retro Body

Part #2042
K2042

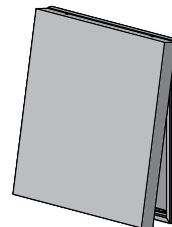
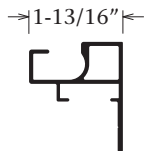

Size H'xW'	Mill Finish	Size H'xW'	Mill Finish	Size H'xW'	Mill Finish	Size H'xW'	Mill Finish
2 x 3	\$114	4 x 4	\$178	6 x 6	\$261	8 x 14	\$468
2 x 4	136	4 x 5	199	6 x 7	281	8 x 15	490
2 x 5	157	4 x 6	218	6 x 8	302	8 x 16	510
2 x 6	178	4 x 7	239	6 x 9	322	8 x 17	532
2 x 7	199	4 x 8	261	6 x 10	343	8 x 18	551
2 x 8	218	4 x 9	281	6 x 11	365	8 x 19	571
2 x 9	239	4 x 10	304	6 x 12	385	8 x 20	594
2 x 10	261	4 x 11	322	6 x 13	406		
2 x 11	281	4 x 12	343	6 x 14	428	9 x 9	385
2 x 12	302	4 x 13	365	6 x 15	447	9 x 10	406
2 x 13	322	4 x 14	385	6 x 16	468	9 x 11	428
2 x 14	343	4 x 15	406	6 x 17	490	9 x 12	447
2 x 15	365	4 x 16	428	6 x 18	510	9 x 13	468
2 x 16	385	4 x 17	447	6 x 19	532	9 x 14	490
2 x 17	406	4 x 18	468	6 x 20	551	9 x 15	510
2 x 18	428	4 x 19	490			9 x 16	532
2 x 19	447	4 x 20	510	7 x 7	304	9 x 17	551
2 x 20	468			7 x 8	322	9 x 18	571
		5 x 5	218	7 x 9	343	9 x 19	594
3 x 3	136	5 x 6	239	7 x 10	365	9 x 20	614
3 x 4	157	5 x 7	261	7 x 11	385		
3 x 5	178	5 x 8	281	7 x 12	406	10 x 10	428
3 x 6	198	5 x 9	302	7 x 13	428	10 x 11	447
3 x 7	218	5 x 10	322	7 x 14	447	10 x 12	468
3 x 8	239	5 x 11	343	7 x 15	468	10 x 13	490
3 x 9	261	5 x 12	365	7 x 16	490	10 x 14	510
3 x 10	281	5 x 13	385	7 x 17	510	10 x 15	530
3 x 11	304	5 x 14	406	7 x 18	530	10 x 16	551
3 x 12	322	5 x 15	428	7 x 19	551	10 x 17	571
3 x 13	343	5 x 16	447	7 x 20	571	10 x 18	594
3 x 14	365	5 x 17	468			10 x 19	614
3 x 15	385	5 x 18	490	8 x 8	343	10 x 20	633
3 x 16	406	5 x 19	510	8 x 9	365		
3 x 17	428	5 x 20	532	8 x 10	385		
3 x 18	447			8 x 11	406		
3 x 19	469			8 x 12	425		
3 x 20	490			8 x 13	447		

Kits Include:

- Mill Finish
- Cut to size and mitered bodies
- All screws required to assemble by mechanical fastening
- All Corner Angles required
- Packaging

Not Included in Kits:

- Face or Back
- Electrical Components
- Mounting Provisions
- Channel Letter Raceway U-Channel - See optional accessories
- Compression Gasket - See optional accessories

Optional Accessories (pg 127):

- Channel Letter Raceway U-Channel
- Compression Gasket

Kit Specifications:

- Custom size kits may be cut to any dimension

Additional Information (pgs 196-197)

Note: All dimensions are subject to the tolerance standards of the aluminum extrusion industry. Profile drawings are illustrative and rounded to the nearest 1/16".

CURRENT PRICE as of April 1, 2022



COMMERCIAL

Unassembled Retro Kits w/out Reveal - For Rigid Faces

Flat Retro Body w/ Flat 1-1/2" Retainer

Part #2041
K2041/52

Part #2052

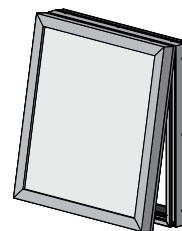
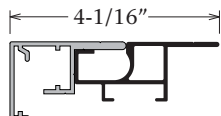

Size H'xW'	Mill Finish	Size H'xW'	Mill Finish	Size H'xW'	Mill Finish	Size H'xW'	Mill Finish
2 x 3	\$225	4 x 4	\$299	6 x 6	\$397	8 x 14	\$648
2 x 4	249	4 x 5	322	6 x 7	423	8 x 15	673
2 x 5	274	4 x 6	348	6 x 8	447	8 x 16	698
2 x 6	299	4 x 7	372	6 x 9	472	8 x 17	722
2 x 7	322	4 x 8	399	6 x 10	499	8 x 18	748
2 x 8	348	4 x 9	423	6 x 11	523	8 x 19	773
2 x 9	372	4 x 10	448	6 x 12	548	8 x 20	799
2 x 10	399	4 x 11	474	6 x 13	574		
2 x 11	424	4 x 12	499	6 x 14	598	9 x 9	547
2 x 12	448	4 x 13	523	6 x 15	623	9 x 10	574
2 x 13	474	4 x 14	548	6 x 16	648	9 x 11	598
2 x 14	499	4 x 15	574	6 x 17	673	9 x 12	623
2 x 15	523	4 x 16	598	6 x 18	698	9 x 13	648
2 x 16	548	4 x 17	623	6 x 19	722	9 x 14	673
2 x 17	574	4 x 18	648	6 x 20	748	9 x 15	698
2 x 18	598	4 x 19	673			9 x 16	722
2 x 19	623	4 x 20	699	7 x 7	448	9 x 17	748
2 x 20	648			7 x 8	474	9 x 18	773
		5 x 5	348	7 x 9	499	9 x 19	797
3 x 3	249	5 x 6	372	7 x 10	523	9 x 20	823
3 x 4	274	5 x 7	397	7 x 11	548		
3 x 5	299	5 x 8	423	7 x 12	574	10 x 10	598
3 x 6	322	5 x 9	447	7 x 13	598	10 x 11	623
3 x 7	348	5 x 10	474	7 x 14	623	10 x 12	648
3 x 8	372	5 x 11	499	7 x 15	648	10 x 13	673
3 x 9	397	5 x 12	523	7 x 16	673	10 x 14	698
3 x 10	423	5 x 13	548	7 x 17	698	10 x 15	722
3 x 11	448	5 x 14	574	7 x 18	722	10 x 16	748
3 x 12	472	5 x 15	598	7 x 19	749	10 x 17	773
3 x 13	499	5 x 16	623	7 x 20	774	10 x 18	797
3 x 14	523	5 x 17	648			10 x 19	824
3 x 15	548	5 x 18	673	8 x 8	499	10 x 20	849
3 x 16	574	5 x 19	698	8 x 9	522		
3 x 17	598	5 x 20	722	8 x 10	548		
3 x 18	623			8 x 11	574		
3 x 19	648			8 x 12	598		
3 x 20	673			8 x 13	623		

Kits Include:

- Mill Finish
- Cut to size and mitered bodies
- Cut to size and mitered retainers
- All screws required to assemble by mechanical fastening
- All Corner Angles and/or Corner Keys required
- Packaging
- Prices reflect one (1) Flat Retro Body kit, SINGLE FACE APPLICATION

Not Included in Kits:

- Face
- Electrical Components
- Divider(s) - See optional accessories
- Mounting Provisions
- Removable retainer option
- Channel Letter Raceway U-Channel - See optional accessories
- Compression Gasket - See optional accessories

Optional Accessories (pg 127):

- Divider(s)
- Channel Letter Raceway U-Channel
- Compression Gasket

Kit Specifications:

- Kits will be cut .325" larger to fit over the existing structure
- Custom size kits may be cut to any dimension
- Illumination may vary depending on application
- For Rigid Plastic or Flush Aluminum Faces

Divider Kits Includes:

- Cut to size dividers
- Mounting Brackets
- All screws required to assemble by mechanical fastening
- Flat 2" Divider, Part #2130, \$8.96 per/ft per/face

Additional Information (pgs 196-197)

Note: It is recommended to use safety chains and prop-bars on all hingeable faces.

Unassembled Single Face Kits w/out Reveal - For Rigid Faces

Flat Wall Mount Retro Body w/ Flat 1-1/2" Retainer

Part #2042
K2042/52

Part #2052

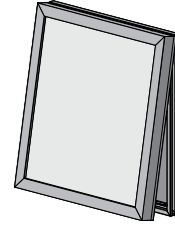
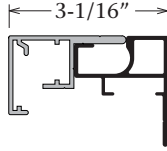

Size H'xW'	Mill Finish	Size H'xW'	Mill Finish	Size H'xW'	Mill Finish	Size H'xW'	Mill Finish
2 x 3	\$225	4 x 4	\$301	6 x 6	\$400	8 x 14	\$653
2 x 4	250	4 x 5	327	6 x 7	425	8 x 15	677
2 x 5	276	4 x 6	352	6 x 8	450	8 x 16	704
2 x 6	301	4 x 7	377	6 x 9	475	8 x 17	729
2 x 7	327	4 x 8	400	6 x 10	502	8 x 18	753
2 x 8	352	4 x 9	425	6 x 11	526	8 x 19	778
2 x 9	377	4 x 10	452	6 x 12	551	8 x 20	805
2 x 10	400	4 x 11	476	6 x 13	576		
2 x 11	425	4 x 12	502	6 x 14	602	9 x 9	551
2 x 12	452	4 x 13	526	6 x 15	627	9 x 10	576
2 x 13	476	4 x 14	552	6 x 16	653	9 x 11	602
2 x 14	502	4 x 15	578	6 x 17	677	9 x 12	627
2 x 15	526	4 x 16	602	6 x 18	702	9 x 13	653
2 x 16	552	4 x 17	627	6 x 19	729	9 x 14	677
2 x 17	578	4 x 18	653	6 x 20	753	9 x 15	702
2 x 18	602	4 x 19	678			9 x 16	729
2 x 19	627	4 x 20	704	7 x 7	452	9 x 17	753
2 x 20	654			7 x 8	476	9 x 18	778
		5 x 5	352	7 x 9	502	9 x 19	804
3 x 3	250	5 x 6	377	7 x 10	526	9 x 20	829
3 x 4	276	5 x 7	400	7 x 11	551		
3 x 5	301	5 x 8	425	7 x 12	576	10 x 10	602
3 x 6	325	5 x 9	450	7 x 13	602	10 x 11	627
3 x 7	352	5 x 10	476	7 x 14	627	10 x 12	653
3 x 8	377	5 x 11	502	7 x 15	653	10 x 13	677
3 x 9	400	5 x 12	526	7 x 16	678	10 x 14	704
3 x 10	425	5 x 13	551	7 x 17	704	10 x 15	729
3 x 11	452	5 x 14	578	7 x 18	729	10 x 16	753
3 x 12	476	5 x 15	602	7 x 19	753	10 x 17	778
3 x 13	502	5 x 16	627	7 x 20	778	10 x 18	804
3 x 14	526	5 x 17	653			10 x 19	829
3 x 15	551	5 x 18	677	8 x 8	502	10 x 20	855
3 x 16	578	5 x 19	704	8 x 9	526		
3 x 17	602	5 x 20	729	8 x 10	551		
3 x 18	627			8 x 11	576		
3 x 19	653			8 x 12	602		
3 x 20	678			8 x 13	627		

Kits Include:

- Mill Finish
- Cut to size and mitered bodies
- Cut to size and mitered retainers
- All screws required to assemble by mechanical fastening
- All Corner Angles and/or Corner Keys required
- Packaging

Not Included in Kits:

- Face or Back
- Electrical Components
- Divider(s) - See optional accessories
- Back Braces and Gussets
- Mounting Provisions
- Removable retainer option
- Channel Letter Raceway U-Channel - See optional accessories
- Compression Gasket - See optional accessories

Optional Accessories (pg 127):

- Divider(s)
- Channel Letter Raceway U-Channel
- Compression Gasket

Kit Specifications:

- Recommended for LED applications
- Custom size kits may be cut to any dimensions
- For Rigid Plastic or Flush Aluminum Faces

Divider Kits Includes:

- Cut to size dividers
- Mounting Brackets
- All screws required to assemble by mechanical fastening
- Flat 2" Divider, Part #2130, \$8.96 per/ft per/face

Additional Information (pgs 196-197)

Note: All dimensions are subject to the tolerance standards of the aluminum extrusion industry. Profile drawings are illustrative and rounded to the nearest 1/16".

CURRENT PRICE as of April 1, 2022



COMMERCIAL

Unassembled Single Face Kits w/out Reveal - For Rigid Faces

Flat S/F Body w/ Flat 1-1/2" Retainer

Part #2027
K2027/52

Part #2052

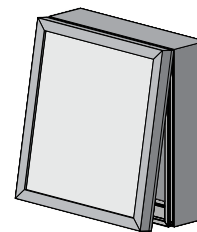
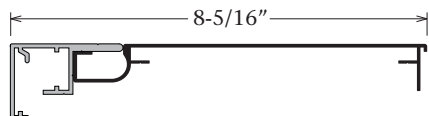

Size H'xW'	Mill Finish	Size H'xW'	Mill Finish	Size H'xW'	Mill Finish	Size H'xW'	Mill Finish
2 x 3	\$281	4 x 4	\$381	6 x 6	\$511	8 x 14	\$839
2 x 4	316	4 x 5	413	6 x 7	544	8 x 15	872
2 x 5	348	4 x 6	445	6 x 8	576	8 x 16	904
2 x 6	381	4 x 7	478	6 x 9	610	8 x 17	936
2 x 7	413	4 x 8	511	6 x 10	642	8 x 18	969
2 x 8	445	4 x 9	544	6 x 11	674	8 x 19	1003
2 x 9	478	4 x 10	576	6 x 12	706	8 x 20	1035
2 x 10	511	4 x 11	611	6 x 13	742		
2 x 11	544	4 x 12	642	6 x 14	774	9 x 9	706
2 x 12	576	4 x 13	676	6 x 15	807	9 x 10	740
2 x 13	611	4 x 14	708	6 x 16	839	9 x 11	773
2 x 14	643	4 x 15	742	6 x 17	872	9 x 12	805
2 x 15	676	4 x 16	774	6 x 18	904	9 x 13	839
2 x 16	708	4 x 17	807	6 x 19	936	9 x 14	872
2 x 17	742	4 x 18	839	6 x 20	969	9 x 15	904
2 x 18	774	4 x 19	872			9 x 16	936
2 x 19	807	4 x 20	904	7 x 7	576	9 x 17	969
2 x 20	839			7 x 8	610	9 x 18	1003
		5 x 5	445	7 x 9	642	9 x 19	1035
3 x 3	314	5 x 6	478	7 x 10	676	9 x 20	1067
3 x 4	348	5 x 7	511	7 x 11	708		
3 x 5	381	5 x 8	544	7 x 12	742	10 x 10	774
3 x 6	413	5 x 9	576	7 x 13	774	10 x 11	807
3 x 7	445	5 x 10	610	7 x 14	807	10 x 12	839
3 x 8	478	5 x 11	642	7 x 15	839	10 x 13	872
3 x 9	511	5 x 12	674	7 x 16	872	10 x 14	904
3 x 10	544	5 x 13	708	7 x 17	904	10 x 15	936
3 x 11	576	5 x 14	742	7 x 18	936	10 x 16	969
3 x 12	610	5 x 15	774	7 x 19	969	10 x 17	1003
3 x 13	642	5 x 16	807	7 x 20	1004	10 x 18	1035
3 x 14	676	5 x 17	839			10 x 19	1069
3 x 15	706	5 x 18	872	8 x 8	642	10 x 20	1102
3 x 16	742	5 x 19	904	8 x 9	674		
3 x 17	774	5 x 20	936	8 x 10	706		
3 x 18	807			8 x 11	742		
3 x 19	839			8 x 12	773		
3 x 20	872			8 x 13	807		

Kits Include:

- Mill Finish
- Cut to size and mitered bodies
- Cut to size and mitered retainers
- All screws required to assemble by mechanical fastening
- All Corner Angles and/or Corner Keys required
- Packaging

Not Included in Kits:

- Face or Back
- Electrical Components
- Divider(s) - See optional accessories
- Back Braces and Gussets
- Mounting Provisions
- Removable retainer option

Optional Accessories (pg 127):

- Divider(s)

Kit Specifications:

- It is recommended to order kits 1" over nominal T12 or T8 lamp size to utilize .040 flat Aluminum Raceway Covers
- Custom size kits may be cut to any dimension
- For Rigid Plastic or Flush Aluminum Faces

Recommended Lamp Spacing:

- For illuminated backgrounds - 12" on center, using T12 or T8 lamps
- Always place lamps 3/4" from back of sign

Divider Kits Includes:

- Cut to size dividers
- Mounting Brackets
- All screws required to assemble by mechanical fastening
- Flat 2" Divider, Part #2130, \$8.96 per/ft per/face

Additional Information (pgs 196-197)

Note: It is recommended to use safety chains and prop-bars on all hingeable faces.

Unassembled Double Face Kits w/out Reveal - For Rigid Faces

Flat D/F Medium Body w/ Flat 1-1/2" Retainer

Part #2007
K2007/52

Part #2052

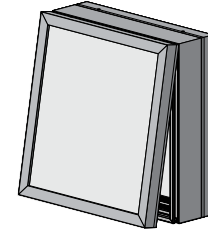
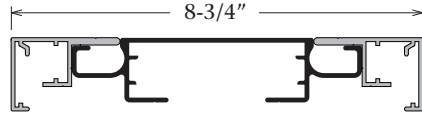

Size H'xW'	Mill Finish	Size H'xW'	Mill Finish	Size H'xW'	Mill Finish	Size H'xW'	Mill Finish
2 x 3	\$411	4 x 4	\$569	6 x 6	\$777	8 x 14	\$1302
2 x 4	464	4 x 5	622	6 x 7	829	8 x 15	1354
2 x 5	516	4 x 6	673	6 x 8	883	8 x 16	1406
2 x 6	569	4 x 7	725	6 x 9	934	8 x 17	1458
2 x 7	622	4 x 8	778	6 x 10	987	8 x 18	1510
2 x 8	674	4 x 9	829	6 x 11	1039	8 x 19	1562
2 x 9	725	4 x 10	883	6 x 12	1090	8 x 20	1616
2 x 10	778	4 x 11	935	6 x 13	1144		
2 x 11	831	4 x 12	988	6 x 14	1196	9 x 9	1090
2 x 12	883	4 x 13	1041	6 x 15	1249	9 x 10	1144
2 x 13	935	4 x 14	1092	6 x 16	1302	9 x 11	1196
2 x 14	988	4 x 15	1145	6 x 17	1354	9 x 12	1248
2 x 15	1039	4 x 16	1197	6 x 18	1406	9 x 13	1300
2 x 16	1092	4 x 17	1251	6 x 19	1458	9 x 14	1354
2 x 17	1145	4 x 18	1302	6 x 20	1511	9 x 15	1404
2 x 18	1197	4 x 19	1355			9 x 16	1458
2 x 19	1251	4 x 20	1407	7 x 7	883	9 x 17	1510
2 x 20	1302			7 x 8	935	9 x 18	1562
		5 x 5	673	7 x 9	987	9 x 19	1616
3 x 3	463	5 x 6	725	7 x 10	1039	9 x 20	1667
3 x 4	516	5 x 7	778	7 x 11	1092		
3 x 5	569	5 x 8	829	7 x 12	1144	10 x 10	1196
3 x 6	621	5 x 9	883	7 x 13	1197	10 x 11	1249
3 x 7	673	5 x 10	935	7 x 14	1249	10 x 12	1300
3 x 8	725	5 x 11	988	7 x 15	1302	10 x 13	1354
3 x 9	777	5 x 12	1039	7 x 16	1355	10 x 14	1406
3 x 10	829	5 x 13	1092	7 x 17	1406	10 x 15	1458
3 x 11	883	5 x 14	1145	7 x 18	1458	10 x 16	1511
3 x 12	935	5 x 15	1196	7 x 19	1511	10 x 17	1562
3 x 13	988	5 x 16	1249	7 x 20	1564	10 x 18	1616
3 x 14	1039	5 x 17	1302			10 x 19	1668
3 x 15	1092	5 x 18	1354	8 x 8	987	10 x 20	1721
3 x 16	1145	5 x 19	1406	8 x 9	1039		
3 x 17	1197	5 x 20	1458	8 x 10	1092		
3 x 18	1249			8 x 11	1144		
3 x 19	1302			8 x 12	1196		
3 x 20	1355			8 x 13	1249		

Kits Include:

- Mill Finish
- Cut to size and mitered bodies
- Cut to size and mitered retainers
- All screws required to assemble by mechanical fastening
- All Corner Angles and/or Corner Keys required
- Packaging

Not Included in Kits:

- Faces
- Electrical Components
- Divider(s) - See optional accessories
- Internal Supports
- Removable retainer option

Optional Accessories (pg 127):

- Dividers(s)

Kit Specifications:

- It is recommended to order kits 1" over nominal T12 or T8 lamp size to utilize .040 flat Aluminum Raceway Covers
- Custom size kits may be cut to any dimension
- For Rigid Plastic or Flush Aluminum Faces

Recommended Lamp Spacing:

- For illuminated backgrounds - 12" on center, using T12 or T8 lamps

Divider Kits Includes:

- Cut to size dividers
- Mounting Brackets
- All screws required to assemble by mechanical fastening
- Flat 2" Divider, Part #2130, \$8.96 per/ft per/face

Additional Information (pgs 196-197)

Note: All dimensions are subject to the tolerance standards of the aluminum extrusion industry. Profile drawings are illustrative and rounded to the nearest 1/16".

**CURRENT PRICE as
of April 1, 2022**



Unassembled Double Face Kits w/out Reveal - For Rigid Faces

Flat D/F Body w/ Flat 1-1/2" Retainer

Part #2008
K2008/52

Part #2052

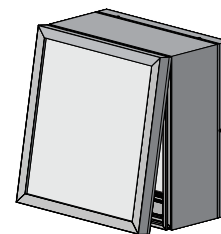
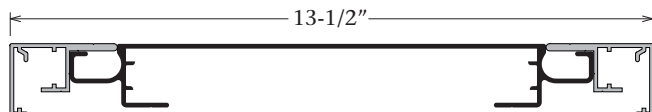

Size H'xW'	Mill Finish	Size H'xW'	Mill Finish	Size H'xW'	Mill Finish	Size H'xW'	Mill Finish
2 x 3	\$494	4 x 4	\$683	6 x 6	\$935	8 x 14	\$1565
2 x 4	559	4 x 5	748	6 x 7	999	8 x 15	1629
2 x 5	622	4 x 6	809	6 x 8	1061	8 x 16	1692
2 x 6	683	4 x 7	874	6 x 9	1122	8 x 17	1756
2 x 7	748	4 x 8	936	6 x 10	1188	8 x 18	1818
2 x 8	809	4 x 9	999	6 x 11	1251	8 x 19	1882
2 x 9	874	4 x 10	1063	6 x 12	1314	8 x 20	1944
2 x 10	936	4 x 11	1125	6 x 13	1376		
2 x 11	999	4 x 12	1189	6 x 14	1441	9 x 9	1314
2 x 12	1061	4 x 13	1252	6 x 15	1502	9 x 10	1376
2 x 13	1125	4 x 14	1315	6 x 16	1565	9 x 11	1439
2 x 14	1189	4 x 15	1376	6 x 17	1629	9 x 12	1502
2 x 15	1251	4 x 16	1441	6 x 18	1692	9 x 13	1564
2 x 16	1315	4 x 17	1504	6 x 19	1756	9 x 14	1629
2 x 17	1378	4 x 18	1565	6 x 20	1818	9 x 15	1691
2 x 18	1441	4 x 19	1630			9 x 16	1755
2 x 19	1504	4 x 20	1693	7 x 7	1061	9 x 17	1818
2 x 20	1569			7 x 8	1125	9 x 18	1881
		5 x 5	809	7 x 9	1188	9 x 19	1944
3 x 3	555	5 x 6	872	7 x 10	1251	9 x 20	2008
3 x 4	621	5 x 7	935	7 x 11	1315		
3 x 5	683	5 x 8	999	7 x 12	1376	10 x 10	1441
3 x 6	746	5 x 9	1061	7 x 13	1441	10 x 11	1502
3 x 7	809	5 x 10	1125	7 x 14	1504	10 x 12	1564
3 x 8	874	5 x 11	1189	7 x 15	1565	10 x 13	1629
3 x 9	935	5 x 12	1251	7 x 16	1630	10 x 14	1692
3 x 10	999	5 x 13	1315	7 x 17	1692	10 x 15	1755
3 x 11	1061	5 x 14	1376	7 x 18	1756	10 x 16	1818
3 x 12	1125	5 x 15	1441	7 x 19	1819	10 x 17	1882
3 x 13	1189	5 x 16	1504	7 x 20	1882	10 x 18	1944
3 x 14	1251	5 x 17	1565			10 x 19	2008
3 x 15	1314	5 x 18	1629	8 x 8	1188	10 x 20	2072
3 x 16	1376	5 x 19	1692	8 x 9	1251		
3 x 17	1441	5 x 20	1756	8 x 10	1314		
3 x 18	1502			8 x 11	1376		
3 x 19	1565			8 x 12	1439		
3 x 20	1630			8 x 13	1502		

Kits Include:

- Mill Finish
- Cut to size and mitered bodies
- Cut to size and mitered retainers
- All screws required to assemble by mechanical fastening
- All Corner Angles and/or Corner Keys required
- Packaging

Not Included in Kits:

- Faces
- Electrical Components
- Divider(s) - See optional accessories
- Internal Supports
- Removable retainer option

Optional Accessories (pg 127):

- Divider(s)

Kit Specifications:

- It is recommended to order kits 1" over nominal T12 or T8 lamp size to utilize .040 flat Aluminum Raceway Covers
- Custom size kits may be cut to any dimension
- For Rigid Plastic or Flush Aluminum Faces

Recommended Lamp Spacing:

- For illuminated backgrounds - 12" on center, using T12 or T8 lamps

Divider Kits Includes:

- Cut to size dividers
- Mounting Brackets
- All screws required to assemble by mechanical fastening
- Flat 2" Divider, Part #2130, \$8.96 per/ft per/face

Additional Information (pgs 196-197)

Note: It is recommended to use safety chains and prop-bars on all hingeable faces.

Unassembled Double Face Kits w/out Reveal - For Rigid Faces

Flat 2 PC D/F Medium Body w/ Flat 1-1/2" Retainer

Part #2010
K2010/52

Part #2052

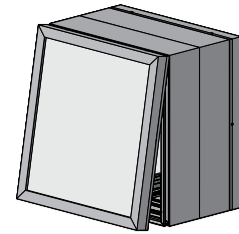
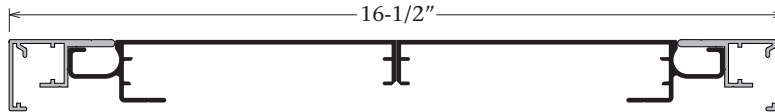

Size H'xW'	Mill Finish	Size H'xW'	Mill Finish	Size H'xW'	Mill Finish	Size H'xW'	Mill Finish
2 x 3	\$576	4 x 4	\$797	6 x 6	\$1089	8 x 14	\$1821
2 x 4	651	4 x 5	871	6 x 7	1162	8 x 15	1894
2 x 5	724	4 x 6	943	6 x 8	1236	8 x 16	1968
2 x 6	797	4 x 7	1015	6 x 9	1309	8 x 17	2040
2 x 7	871	4 x 8	1090	6 x 10	1381	8 x 18	2114
2 x 8	943	4 x 9	1162	6 x 11	1454	8 x 19	2187
2 x 9	1015	4 x 10	1237	6 x 12	1528	8 x 20	2261
2 x 10	1090	4 x 11	1311	6 x 13	1602		
2 x 11	1164	4 x 12	1382	6 x 14	1676	9 x 9	1528
2 x 12	1236	4 x 13	1455	6 x 15	1748	9 x 10	1601
2 x 13	1311	4 x 14	1529	6 x 16	1821	9 x 11	1676
2 x 14	1382	4 x 15	1602	6 x 17	1894	9 x 12	1746
2 x 15	1455	4 x 16	1677	6 x 18	1968	9 x 13	1821
2 x 16	1529	4 x 17	1751	6 x 19	2040	9 x 14	1894
2 x 17	1602	4 x 18	1821	6 x 20	2115	9 x 15	1968
2 x 18	1676	4 x 19	1895			9 x 16	2040
2 x 19	1751	4 x 20	1969	7 x 7	1236	9 x 17	2114
2 x 20	1822			7 x 8	1311	9 x 18	2186
		5 x 5	943	7 x 9	1381	9 x 19	2259
3 x 3	649	5 x 6	1015	7 x 10	1455	9 x 20	2334
3 x 4	724	5 x 7	1089	7 x 11	1529		
3 x 5	797	5 x 8	1162	7 x 12	1602	10 x 10	1676
3 x 6	871	5 x 9	1236	7 x 13	1676	10 x 11	1748
3 x 7	943	5 x 10	1311	7 x 14	1748	10 x 12	1821
3 x 8	1015	5 x 11	1382	7 x 15	1821	10 x 13	1894
3 x 9	1089	5 x 12	1454	7 x 16	1895	10 x 14	1968
3 x 10	1162	5 x 13	1529	7 x 17	1969	10 x 15	2040
3 x 11	1236	5 x 14	1602	7 x 18	2040	10 x 16	2115
3 x 12	1309	5 x 15	1676	7 x 19	2115	10 x 17	2187
3 x 13	1382	5 x 16	1748	7 x 20	2187	10 x 18	2259
3 x 14	1455	5 x 17	1821			10 x 19	2334
3 x 15	1529	5 x 18	1894	8 x 8	1381	10 x 20	2408
3 x 16	1602	5 x 19	1969	8 x 9	1454		
3 x 17	1676	5 x 20	2042	8 x 10	1529		
3 x 18	1748			8 x 11	1602		
3 x 19	1821			8 x 12	1676		
3 x 20	1895			8 x 13	1748		

Kits Include:

- Mill Finish
- Cut to size and mitered bodies
- Cut to size and mitered retainers
- All screws required to assemble by mechanical fastening
- All Corner Angles and/or Corner Keys required
- Packaging

Not Included in Kits:

- Faces
- Electrical Components
- Divider(s) - See optional accessories
- Internal Supports
- Removable retainer option

Optional Accessories (pg 127):

- Dividers(s)

Kit Specifications:

- It is recommended to order kits 1" over nominal T12 or T8 lamp size to utilize .040 flat Aluminum Raceway Covers
- Custom size kits may be cut to any dimension
- For Rigid Plastic or Flush Aluminum Faces

Recommended Lamp Spacing:

- For illuminated backgrounds - 12" on center, using T12 or T8 lamps

Divider Kits Includes:

- Cut to size dividers
- Mounting Brackets
- All screws required to assemble by mechanical fastening
- Flat 2" Divider, Part #2130, \$8.96 per/ft per/face

Additional Information (pgs 196-197)

Note: It is recommended to use safety chains and prop-bars on hingeable faces.

Note: All dimensions are subject to the tolerance standards of the aluminum extrusion industry. Profile drawings are illustrative and rounded to the nearest 1/16".

CURRENT PRICE as of April 1, 2022



COMMERCIAL

Unassembled Double Face Kits w/out Reveal - For Rigid Faces

Flat 2 PC D/F Body w/ Flat 1-1/2" Retainer

Part #2009
K2009/52

Part #2052

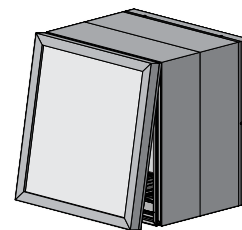
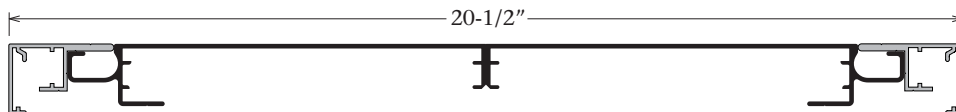

Size H'xW'	Mill Finish	Size H'xW'	Mill Finish	Size H'xW'	Mill Finish	Size H'xW'	Mill Finish
2 x 3	\$643	4 x 4	\$887	6 x 6	\$1212	8 x 14	\$2024
2 x 4	725	4 x 5	969	6 x 7	1293	8 x 15	2105
2 x 5	807	4 x 6	1051	6 x 8	1375	8 x 16	2187
2 x 6	887	4 x 7	1132	6 x 9	1455	8 x 17	2269
2 x 7	969	4 x 8	1213	6 x 10	1537	8 x 18	2350
2 x 8	1051	4 x 9	1295	6 x 11	1620	8 x 19	2432
2 x 9	1132	4 x 10	1375	6 x 12	1700	8 x 20	2515
2 x 10	1213	4 x 11	1457	6 x 13	1782		
2 x 11	1295	4 x 12	1538	6 x 14	1863	9 x 9	1699
2 x 12	1375	4 x 13	1620	6 x 15	1944	9 x 10	1782
2 x 13	1457	4 x 14	1702	6 x 16	2024	9 x 11	1862
2 x 14	1538	4 x 15	1783	6 x 17	2107	9 x 12	1942
2 x 15	1620	4 x 16	1863	6 x 18	2187	9 x 13	2024
2 x 16	1702	4 x 17	1945	6 x 19	2269	9 x 14	2105
2 x 17	1783	4 x 18	2026	6 x 20	2351	9 x 15	2186
2 x 18	1863	4 x 19	2107			9 x 16	2269
2 x 19	1945	4 x 20	2190	7 x 7	1375	9 x 17	2350
2 x 20	2026			7 x 8	1455	9 x 18	2432
		5 x 5	1051	7 x 9	1537	9 x 19	2512
3 x 3	724	5 x 6	1132	7 x 10	1620	9 x 20	2595
3 x 4	807	5 x 7	1212	7 x 11	1700		
3 x 5	887	5 x 8	1295	7 x 12	1782	10 x 10	1863
3 x 6	967	5 x 9	1375	7 x 13	1863	10 x 11	1944
3 x 7	1051	5 x 10	1455	7 x 14	1944	10 x 12	2024
3 x 8	1132	5 x 11	1538	7 x 15	2024	10 x 13	2107
3 x 9	1212	5 x 12	1620	7 x 16	2107	10 x 14	2187
3 x 10	1295	5 x 13	1700	7 x 17	2187	10 x 15	2269
3 x 11	1375	5 x 14	1783	7 x 18	2269	10 x 16	2351
3 x 12	1455	5 x 15	1863	7 x 19	2351	10 x 17	2432
3 x 13	1538	5 x 16	1944	7 x 20	2433	10 x 18	2512
3 x 14	1620	5 x 17	2026			10 x 19	2595
3 x 15	1700	5 x 18	2107	8 x 8	1537	10 x 20	2675
3 x 16	1783	5 x 19	2187	8 x 9	1617		
3 x 17	1863	5 x 20	2271	8 x 10	1700		
3 x 18	1944			8 x 11	1782		
3 x 19	2026			8 x 12	1862		
3 x 20	2107			8 x 13	1944		

Kits Include:

- Mill Finish
- Cut to size and mitered bodies
- Cut to size and mitered retainers
- All screws required to assemble by mechanical fastening
- All Corner Angles and/or Corner Keys required
- Packaging

Not Included in Kits:

- Faces
- Electrical Components
- Divider(s) - See optional accessories
- Internal Supports
- Removable retainer option

Optional Accessories (pg 127):

- Divider(s)

Kit Specifications:

- It is recommended to order kits 1" over nominal T12 or T8 lamp size to utilize .040 flat Aluminum Raceway Covers
- Custom size kits may be cut to any dimension
- For Rigid Plastic or Flush Aluminum Faces

Recommended Lamp Spacing:

- For illuminated backgrounds - 12" on center, using T12 or T8 lamps

Divider Kits Includes:

- Cut to size dividers
- Mounting Brackets
- All screws required to assemble by mechanical fastening
- Flat 2" Divider, Part #2130, \$8.96 per/ft per/face

Additional Information (pgs 196-197)

Note: It is recommended to use safety chains and prop-bars on hingeable faces.

Unassembled Retro Kits w/out Reveal - For Rigid Faces

Flat Retro Body w/ Flat 2" Retainer

Part #2041
K2041/47

Part #2047

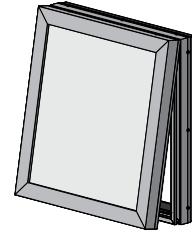
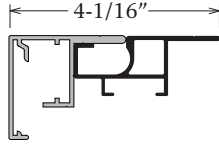

Size H'xW'	Mill Finish	Size H'xW'	Mill Finish	Size H'xW'	Mill Finish	Size H'xW'	Mill Finish
2 x 3	\$234	4 x 4	\$316	6 x 6	\$421	8 x 14	\$688
2 x 4	262	4 x 5	341	6 x 7	447	8 x 15	714
2 x 5	289	4 x 6	368	6 x 8	474	8 x 16	742
2 x 6	316	4 x 7	395	6 x 9	500	8 x 17	768
2 x 7	341	4 x 8	423	6 x 10	528	8 x 18	795
2 x 8	368	4 x 9	447	6 x 11	554	8 x 19	821
2 x 9	395	4 x 10	475	6 x 12	581	8 x 20	847
2 x 10	423	4 x 11	502	6 x 13	607		
2 x 11	448	4 x 12	528	6 x 14	633	9 x 9	581
2 x 12	475	4 x 13	554	6 x 15	661	9 x 10	607
2 x 13	502	4 x 14	581	6 x 16	688	9 x 11	633
2 x 14	528	4 x 15	607	6 x 17	716	9 x 12	661
2 x 15	554	4 x 16	637	6 x 18	742	9 x 13	688
2 x 16	581	4 x 17	662	6 x 19	768	9 x 14	714
2 x 17	607	4 x 18	689	6 x 20	795	9 x 15	740
2 x 18	633	4 x 19	716			9 x 16	768
2 x 19	662	4 x 20	742	7 x 7	475	9 x 17	795
2 x 20	689			7 x 8	502	9 x 18	821
		5 x 5	368	7 x 9	528	9 x 19	847
		5 x 6	395	7 x 10	554	9 x 20	874
		5 x 7	421	7 x 11	581		
		5 x 8	447	7 x 12	607	10 x 10	633
		5 x 9	474	7 x 13	633	10 x 11	661
		5 x 10	502	7 x 14	661	10 x 12	688
		5 x 11	528	7 x 15	688	10 x 13	716
		5 x 12	554	7 x 16	716	10 x 14	742
		5 x 13	581	7 x 17	742	10 x 15	768
		5 x 14	607	7 x 18	768	10 x 16	795
		5 x 15	633	7 x 19	795	10 x 17	821
		5 x 16	661	7 x 20	821	10 x 18	847
		5 x 17	689			10 x 19	874
		5 x 18	716	8 x 8	528	10 x 20	900
		5 x 19	742	8 x 9	554		
		5 x 20	768	8 x 10	581		
				8 x 11	607		
				8 x 12	633		
				8 x 13	661		

Kits Include:

- Mill Finish
- Cut to size and mitered bodies
- Cut to size and mitered retainers
- All screws required to assemble by mechanical fastening
- All Corner Angles and/or Corner Keys required
- Packaging
- Prices reflect one (1) Flat Retro Body kit, SINGLE FACE APPLICATION

Not Included in Kits:

- Face
- Electrical Components
- Divider(s) - See optional accessories
- Mounting Provisions
- Removable retainer option
- Channel Letter Raceway U-Channel - See optional accessories
- Compression Gasket - See optional accessories

Optional Accessories (pg 127):

- Dividers(s)
- Channel Letter Raceway U-Channel
- Compression Gasket

Kit Specifications:

- Kits will be cut .325" larger to fit over the existing structure
- Custom size kits may be cut to any dimension
- Illumination may vary depending on application
- For Rigid Plastic or Flush Aluminum Faces

Divider Kits Includes:

- Cut to size dividers
- Mounting Brackets
- All screws required to assemble by mechanical fastening
- Flat 2" Divider, Part #2130, \$8.96 per/ft per/face

Additional Information (pgs 196-197)

Note: All dimensions are subject to the tolerance standards of the aluminum extrusion industry. Profile drawings are illustrative and rounded to the nearest 1/16".

CURRENT PRICE as of April 1, 2022



COMMERCIAL

Unassembled Single Face Kits w/out Reveal - For Rigid Faces

Flat Wall Mount Retro Body w/ Flat 2" Retainer

Part #2042
K2042/47

Part #2047

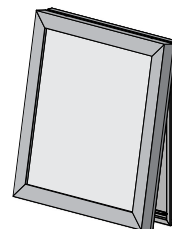
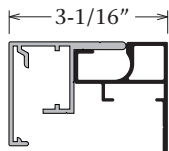

Size H'xW'	Mill Finish	Size H'xW'	Mill Finish	Size H'xW'	Mill Finish	Size H'xW'	Mill Finish
2 x 3	\$236	4 x 4	\$317	6 x 6	\$424	8 x 14	\$693
2 x 4	264	4 x 5	343	6 x 7	450	8 x 15	720
2 x 5	290	4 x 6	371	6 x 8	476	8 x 16	746
2 x 6	317	4 x 7	397	6 x 9	506	8 x 17	773
2 x 7	343	4 x 8	424	6 x 10	532	8 x 18	799
2 x 8	371	4 x 9	450	6 x 11	559	8 x 19	827
2 x 9	397	4 x 10	478	6 x 12	585	8 x 20	853
2 x 10	424	4 x 11	506	6 x 13	613		
2 x 11	452	4 x 12	532	6 x 14	639	9 x 9	585
2 x 12	478	4 x 13	560	6 x 15	666	9 x 10	613
2 x 13	506	4 x 14	586	6 x 16	693	9 x 11	639
2 x 14	532	4 x 15	613	6 x 17	720	9 x 12	666
2 x 15	559	4 x 16	639	6 x 18	746	9 x 13	692
2 x 16	586	4 x 17	667	6 x 19	773	9 x 14	720
2 x 17	613	4 x 18	693	6 x 20	800	9 x 15	746
2 x 18	639	4 x 19	720			9 x 16	773
2 x 19	667	4 x 20	746	7 x 7	478	9 x 17	799
2 x 20	693			7 x 8	506	9 x 18	827
		5 x 5	371	7 x 9	532	9 x 19	853
3 x 3	262	5 x 6	397	7 x 10	559	9 x 20	880
3 x 4	290	5 x 7	424	7 x 11	586		
3 x 5	317	5 x 8	450	7 x 12	613	10 x 10	639
3 x 6	343	5 x 9	476	7 x 13	639	10 x 11	666
3 x 7	371	5 x 10	506	7 x 14	666	10 x 12	692
3 x 8	397	5 x 11	532	7 x 15	693	10 x 13	720
3 x 9	424	5 x 12	559	7 x 16	720	10 x 14	746
3 x 10	450	5 x 13	586	7 x 17	746	10 x 15	773
3 x 11	478	5 x 14	613	7 x 18	773	10 x 16	800
3 x 12	506	5 x 15	639	7 x 19	800	10 x 17	827
3 x 13	532	5 x 16	666	7 x 20	827	10 x 18	853
3 x 14	559	5 x 17	693			10 x 19	880
3 x 15	586	5 x 18	720	8 x 8	532	10 x 20	907
3 x 16	613	5 x 19	746	8 x 9	559		
3 x 17	639	5 x 20	774	8 x 10	586		
3 x 18	666			8 x 11	613		
3 x 19	693			8 x 12	639		
3 x 20	720			8 x 13	666		

Kits Include:

- Mill Finish
- Cut to size and mitered bodies
- Cut to size and mitered retainers
- All screws required to assemble by mechanical fastening
- All Corner Angles and/or Corner Keys required
- Packaging

Not Included in Kits:

- Face or Back
- Electrical Components
- Divider(s) - See optional accessories
- Back Braces and Gussets
- Mounting Provisions
- Removable retainer option
- Channel Letter Raceway U-Channel - See optional accessories
- Compression Gasket - See optional accessories

Optional Accessories (pg 127):

- Divider(s)
- Channel Letter Raceway U-Channel
- Compression Gasket

Kit Specifications:

- Recommended for LED applications
- Custom size kits may be cut to any dimensions
- For Rigid Plastic or Flush Aluminum Faces

Divider Kits Includes:

- Cut to size dividers
- Mounting Brackets
- All screws required to assemble by mechanical fastening
- Flat 2" Divider, Part #2130, \$8.96 per/ft per/face

Additional Information (pgs 196-197)

Unassembled Single Face Kits w/out Reveal - For Rigid Faces

Flat S/F Body w/ Flat 2" Retainer

Part #2027
K2027/47

Part #2047

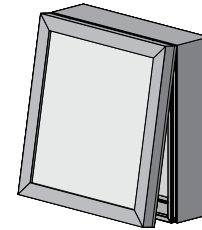
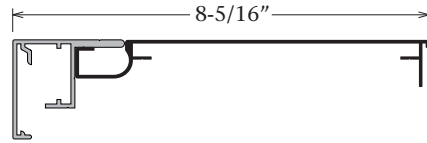

Size H'xW'	Mill Finish	Size H'xW'	Mill Finish	Size H'xW'	Mill Finish	Size H'xW'	Mill Finish
2 x 3	\$293	4 x 4	\$397	6 x 6	\$535	8 x 14	\$878
2 x 4	328	4 x 5	432	6 x 7	569	8 x 15	912
2 x 5	364	4 x 6	467	6 x 8	602	8 x 16	948
2 x 6	397	4 x 7	500	6 x 9	638	8 x 17	982
2 x 7	432	4 x 8	535	6 x 10	671	8 x 18	1015
2 x 8	467	4 x 9	569	6 x 11	706	8 x 19	1051
2 x 9	500	4 x 10	603	6 x 12	742	8 x 20	1085
2 x 10	535	4 x 11	639	6 x 13	776		
2 x 11	569	4 x 12	673	6 x 14	809	9 x 9	740
2 x 12	602	4 x 13	706	6 x 15	844	9 x 10	776
2 x 13	639	4 x 14	742	6 x 16	878	9 x 11	809
2 x 14	673	4 x 15	776	6 x 17	912	9 x 12	844
2 x 15	706	4 x 16	809	6 x 18	947	9 x 13	878
2 x 16	742	4 x 17	844	6 x 19	982	9 x 14	912
2 x 17	776	4 x 18	878	6 x 20	1015	9 x 15	947
2 x 18	809	4 x 19	914			9 x 16	982
2 x 19	844	4 x 20	948	7 x 7	602	9 x 17	1015
2 x 20	880			7 x 8	638	9 x 18	1051
		5 x 5	467	7 x 9	671	9 x 19	1085
3 x 3	328	5 x 6	500	7 x 10	706	9 x 20	1118
3 x 4	362	5 x 7	535	7 x 11	742		
3 x 5	397	5 x 8	569	7 x 12	776	10 x 10	809
3 x 6	431	5 x 9	602	7 x 13	809	10 x 11	844
3 x 7	467	5 x 10	638	7 x 14	844	10 x 12	878
3 x 8	500	5 x 11	673	7 x 15	878	10 x 13	912
3 x 9	535	5 x 12	706	7 x 16	914	10 x 14	948
3 x 10	569	5 x 13	742	7 x 17	948	10 x 15	982
3 x 11	602	5 x 14	776	7 x 18	982	10 x 16	1015
3 x 12	638	5 x 15	809	7 x 19	1015	10 x 17	1051
3 x 13	673	5 x 16	844	7 x 20	1051	10 x 18	1085
3 x 14	706	5 x 17	878			10 x 19	1118
3 x 15	742	5 x 18	912	8 x 8	671	10 x 20	1153
3 x 16	776	5 x 19	948	8 x 9	705		
3 x 17	809	5 x 20	982	8 x 10	742		
3 x 18	844			8 x 11	776		
3 x 19	878			8 x 12	809		
3 x 20	914			8 x 13	844		

<p>Kits Include:</p> <ul style="list-style-type: none"> • Mill Finish • Cut to size and mitered bodies • Cut to size and mitered retainers • All screws required to assemble by mechanical fastening • All Corner Angles and/or Corner Keys required • Packaging <p>Not Included in Kits:</p> <ul style="list-style-type: none"> • Face or Back • Electrical Components • Divider(s) - See optional accessories • Back Braces and Gussets • Mounting Provisions • Removable retainer option 	<p>Optional Accessories (pg 127):</p> <ul style="list-style-type: none"> • Divider(s) <p>Kit Specifications:</p> <ul style="list-style-type: none"> • It is recommended to order kits 1" over nominal T12 or T8 lamp size to utilize .040 flat Aluminum Raceway Covers • Custom size kits may be cut to any dimension • For Rigid Plastic or Flush Aluminum Faces <p>Recommended Lamp Spacing:</p> <ul style="list-style-type: none"> • For illuminated backgrounds - 12" on center, using T12 or T8 lamps • Always place lamps 3/4" from back of sign 	<p>Divider Kits Includes:</p> <ul style="list-style-type: none"> • Cut to size dividers • Mounting Brackets • All screws required to assemble by mechanical fastening • Flat 2" Divider, Part #2130, \$8.96 per/ft per/face <p>Additional Information (pgs 196-197)</p>
---	---	---

Note: It is recommended to use safety chains and prop-bars on all hingeable faces.

Note: All dimensions are subject to the tolerance standards of the aluminum extrusion industry. Profile drawings are illustrative and rounded to the nearest 1/16".

CURRENT PRICE as of April 1, 2022



Unassembled Double Face Kits w/out Reveal - For Rigid Faces

Flat D/F Medium Body w/ Flat 2" Retainer

Part #2007
K2007/47

Part #2047

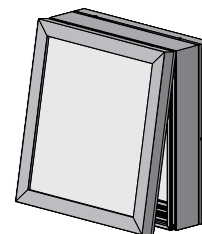
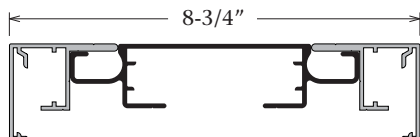

Size H'xW'	Mill Finish	Size H'xW'	Mill Finish	Size H'xW'	Mill Finish	Size H'xW'	Mill Finish
2 x 3	\$435	4 x 4	\$602	6 x 6	\$824	8 x 14	\$1381
2 x 4	491	4 x 5	658	6 x 7	880	8 x 15	1435
2 x 5	547	4 x 6	714	6 x 8	935	8 x 16	1493
2 x 6	601	4 x 7	769	6 x 9	990	8 x 17	1548
2 x 7	658	4 x 8	825	6 x 10	1046	8 x 18	1602
2 x 8	714	4 x 9	880	6 x 11	1102	8 x 19	1660
2 x 9	769	4 x 10	936	6 x 12	1158	8 x 20	1714
2 x 10	825	4 x 11	991	6 x 13	1213	9 x 9	1158
2 x 11	881	4 x 12	1046	6 x 14	1269	9 x 10	1213
2 x 12	935	4 x 13	1104	6 x 15	1324	9 x 11	1269
2 x 13	991	4 x 14	1160	6 x 16	1381	9 x 12	1324
2 x 14	1046	4 x 15	1213	6 x 17	1435	9 x 13	1379
2 x 15	1104	4 x 16	1271	6 x 18	1493	9 x 14	1435
2 x 16	1160	4 x 17	1325	6 x 19	1548	9 x 15	1491
2 x 17	1216	4 x 18	1381	6 x 20	1604	9 x 16	1548
2 x 18	1269	4 x 19	1438	7 x 7	935	9 x 17	1602
2 x 19	1325	4 x 20	1494	7 x 8	991	9 x 18	1657
2 x 20	1381			7 x 9	1046	9 x 19	1714
		5 x 5	714	7 x 10	1104	9 x 20	1770
3 x 3	490	5 x 6	769	7 x 11	1160		
3 x 4	547	5 x 7	825	7 x 12	1213	10 x 10	1269
3 x 5	601	5 x 8	880	7 x 13	1269	10 x 11	1325
3 x 6	657	5 x 9	935	7 x 14	1325	10 x 12	1379
3 x 7	714	5 x 10	991	7 x 15	1381	10 x 13	1435
3 x 8	769	5 x 11	1046	7 x 16	1438	10 x 14	1493
3 x 9	824	5 x 12	1102	7 x 17	1493	10 x 15	1548
3 x 10	880	5 x 13	1160	7 x 18	1548	10 x 16	1604
3 x 11	935	5 x 14	1213	7 x 19	1604	10 x 17	1660
3 x 12	991	5 x 15	1269	7 x 20	1660	10 x 18	1714
3 x 13	1046	5 x 16	1325			10 x 19	1770
3 x 14	1104	5 x 17	1381	8 x 8	1046	10 x 20	1826
3 x 15	1158	5 x 18	1435	8 x 9	1102		
3 x 16	1213	5 x 19	1493	8 x 10	1158		
3 x 17	1269	5 x 20	1548	8 x 11	1213		
3 x 18	1325			8 x 12	1269		
3 x 19	1381			8 x 13	1325		
3 x 20	1438						

Kits Include:

- Mill Finish
- Cut to size and mitered bodies
- Cut to size and mitered retainers
- All screws required to assemble by mechanical fastening
- All Corner Angles and/or Corner Keys required
- Packaging

Not Included in Kits:

- Faces
- Electrical Components
- Divider(s) - See optional accessories
- Internal Supports
- Removable retainer option

Optional Accessories (pg 127):

- Divider(s)

Kit Specifications:

- It is recommended to order kits 1" over nominal T12 or T8 lamp size to utilize .040 flat Aluminum Raceway Covers
- Custom size kits may be cut to any dimension
- For Rigid Plastic or Flush Aluminum Faces

Recommended Lamp Spacing:

- For illuminated backgrounds - 12" on center, using T12 or T8 lamps

Divider Kits Includes:

- Cut to size dividers
- Mounting Brackets
- All screws required to assemble by mechanical fastening
- Flat 2" Divider, Part #2130, \$8.96 per/ft per/face

Additional Information (pgs 196-197)

Note: It is recommended to use safety chains and prop-bars on all hingeable faces.

Unassembled Double Face Kits w/out Reveal - For Rigid Faces

Flat D/F Body w/ Flat 2" Retainer

Part #2008
K2008/47

Part #2047

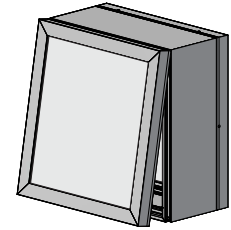
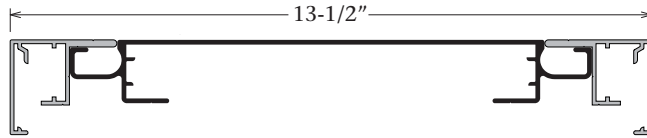

Size H'xW'	Mill Finish	Size H'xW'	Mill Finish	Size H'xW'	Mill Finish	Size H'xW'	Mill Finish
2 x 3	\$519	4 x 4	\$718	6 x 6	\$982	8 x 14	\$1647
2 x 4	586	4 x 5	784	6 x 7	1050	8 x 15	1711
2 x 5	651	4 x 6	851	6 x 8	1114	8 x 16	1778
2 x 6	718	4 x 7	916	6 x 9	1181	8 x 17	1844
2 x 7	784	4 x 8	983	6 x 10	1248	8 x 18	1910
2 x 8	851	4 x 9	1050	6 x 11	1314	8 x 19	1976
2 x 9	916	4 x 10	1116	6 x 12	1379	8 x 20	2044
2 x 10	983	4 x 11	1183	6 x 13	1447		
2 x 11	1050	4 x 12	1248	6 x 14	1511	9 x 9	1378
2 x 12	1116	4 x 13	1315	6 x 15	1578	9 x 10	1446
2 x 13	1183	4 x 14	1381	6 x 16	1647	9 x 11	1511
2 x 14	1248	4 x 15	1447	6 x 17	1711	9 x 12	1577
2 x 15	1315	4 x 16	1513	6 x 18	1778	9 x 13	1644
2 x 16	1381	4 x 17	1580	6 x 19	1844	9 x 14	1711
2 x 17	1447	4 x 18	1647	6 x 20	1910	9 x 15	1776
2 x 18	1513	4 x 19	1712			9 x 16	1843
2 x 19	1580	4 x 20	1779	7 x 7	1116	9 x 17	1910
2 x 20	1647			7 x 8	1181	9 x 18	1974
		5 x 5	851	7 x 9	1248	9 x 19	2042
3 x 3	585	5 x 6	915	7 x 10	1315	9 x 20	2108
3 x 4	651	5 x 7	982	7 x 11	1379		
3 x 5	718	5 x 8	1050	7 x 12	1447	10 x 10	1511
3 x 6	783	5 x 9	1114	7 x 13	1513	10 x 11	1578
3 x 7	851	5 x 10	1181	7 x 14	1578	10 x 12	1644
3 x 8	916	5 x 11	1248	7 x 15	1647	10 x 13	1711
3 x 9	982	5 x 12	1314	7 x 16	1712	10 x 14	1778
3 x 10	1050	5 x 13	1379	7 x 17	1778	10 x 15	1843
3 x 11	1116	5 x 14	1447	7 x 18	1844	10 x 16	1910
3 x 12	1181	5 x 15	1511	7 x 19	1911	10 x 17	1976
3 x 13	1248	5 x 16	1578	7 x 20	1976	10 x 18	2042
3 x 14	1315	5 x 17	1647			10 x 19	2108
3 x 15	1379	5 x 18	1711	8 x 8	1248	10 x 20	2175
3 x 16	1447	5 x 19	1778	8 x 9	1314		
3 x 17	1513	5 x 20	1844	8 x 10	1379		
3 x 18	1578			8 x 11	1447		
3 x 19	1647			8 x 12	1511		
3 x 20	1712			8 x 13	1578		

Kits Include:

- Mill Finish
- Cut to size and mitered bodies
- Cut to size and mitered retainers
- All screws required to assemble by mechanical fastening
- All Corner Angles and/or Corner Keys required
- Packaging

Not Included in Kits:

- Faces
- Electrical Components
- Divider(s) - See optional accessories
- Internal Supports
- Removable retainer option

Optional Accessories (pg 127):

- Divider(s)

Kit Specifications:

- It is recommended to order kits 1" over nominal T12 or T8 lamp size to utilize .040 flat Aluminum Raceway Covers
- Custom size kits may be cut to any dimension
- For Rigid Plastic or Flush Aluminum Faces

Recommended Lamp Spacing:

- For illuminated backgrounds - 12" on center, using T12 or T8 lamps

Divider Kits Includes:

- Cut to size dividers
- Mounting Brackets
- All screws required to assemble by mechanical fastening
- Flat 2" Divider, Part #2130, \$8.96 per/ft per/face

Additional Information (pgs 196-197)

Note: All dimensions are subject to the tolerance standards of the aluminum extrusion industry. Profile drawings are illustrative and rounded to the nearest 1/16".

Unassembled Double Face Kits w/out Reveal - For Rigid Faces

Flat 2 PC D/F Medium Body w/ Flat 2" Retainer

Part #2010
K2010/47

Part #2047

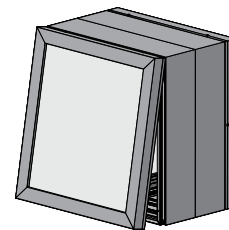
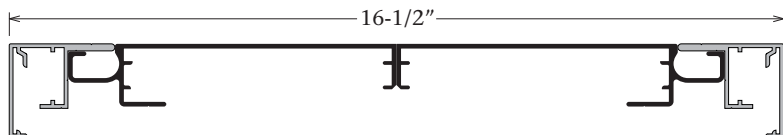

Size H'xW'	Mill Finish	Size H'xW'	Mill Finish	Size H'xW'	Mill Finish	Size H'xW'	Mill Finish
2 x 3	\$601	4 x 4	\$831	6 x 6	\$1136	8 x 14	\$1900
2 x 4	677	4 x 5	907	6 x 7	1212	8 x 15	1976
2 x 5	755	4 x 6	983	6 x 8	1288	8 x 16	2052
2 x 6	829	4 x 7	1060	6 x 9	1364	8 x 17	2130
2 x 7	907	4 x 8	1137	6 x 10	1442	8 x 18	2204
2 x 8	983	4 x 9	1212	6 x 11	1518	8 x 19	2282
2 x 9	1060	4 x 10	1290	6 x 12	1595	8 x 20	2358
2 x 10	1137	4 x 11	1366	6 x 13	1671		
2 x 11	1213	4 x 12	1442	6 x 14	1748	9 x 9	1593
2 x 12	1290	4 x 13	1520	6 x 15	1822	9 x 10	1671
2 x 13	1366	4 x 14	1596	6 x 16	1900	9 x 11	1746
2 x 14	1442	4 x 15	1672	6 x 17	1976	9 x 12	1822
2 x 15	1518	4 x 16	1748	6 x 18	2052	9 x 13	1900
2 x 16	1596	4 x 17	1823	6 x 19	2130	9 x 14	1976
2 x 17	1672	4 x 18	1900	6 x 20	2206	9 x 15	2052
2 x 18	1748	4 x 19	1977			9 x 16	2128
2 x 19	1823	4 x 20	2053	7 x 7	1290	9 x 17	2204
2 x 20	1901			7 x 8	1366	9 x 18	2281
		5 x 5	983	7 x 9	1442	9 x 19	2358
3 x 3	677	5 x 6	1060	7 x 10	1518	9 x 20	2435
3 x 4	753	5 x 7	1136	7 x 11	1595		
3 x 5	829	5 x 8	1212	7 x 12	1671	10 x 10	1748
3 x 6	906	5 x 9	1288	7 x 13	1748	10 x 11	1823
3 x 7	983	5 x 10	1366	7 x 14	1823	10 x 12	1900
3 x 8	1060	5 x 11	1442	7 x 15	1900	10 x 13	1976
3 x 9	1136	5 x 12	1518	7 x 16	1976	10 x 14	2052
3 x 10	1212	5 x 13	1595	7 x 17	2053	10 x 15	2128
3 x 11	1290	5 x 14	1672	7 x 18	2130	10 x 16	2206
3 x 12	1366	5 x 15	1748	7 x 19	2206	10 x 17	2282
3 x 13	1442	5 x 16	1823	7 x 20	2282	10 x 18	2358
3 x 14	1518	5 x 17	1900			10 x 19	2435
3 x 15	1595	5 x 18	1976	8 x 8	1442	10 x 20	2512
3 x 16	1672	5 x 19	2053	8 x 9	1518		
3 x 17	1748	5 x 20	2130	8 x 10	1595		
3 x 18	1823			8 x 11	1671		
3 x 19	1900			8 x 12	1746		
3 x 20	1976			8 x 13	1823		

Kits Include:

- Mill Finish
- Cut to size and mitered bodies
- Cut to size and mitered retainers
- All screws required to assemble by mechanical fastening
- All Corner Angles and/or Corner Keys required
- Packaging

Not Included in Kits:

- Faces
- Electrical Components
- Divider(s) - See optional accessories
- Internal Supports
- Removable retainer option

Optional Accessories (pg 127):

- Divider(s)

Kit Specifications:

- It is recommended to order kits 1" over nominal T12 or T8 lamp size to utilize .040 flat Aluminum Raceway Covers
- Custom size kits may be cut to any dimension
- For Rigid Plastic or Flush Aluminum Faces

Recommended Lamp Spacing:

- For illuminated backgrounds - 12" on center, using T12 or T8 lamps

Divider Kits Includes:

- Cut to size dividers
- Mounting Brackets
- All screws required to assemble by mechanical fastening
- Flat 2" Divider, Part #2130, \$8.96 per/ft per/face

Additional Information (pgs 196-197)

Note: It is recommended to use safety chains and prop-bars on hingeable faces.

Unassembled Double Face Kits w/out Reveal - For Rigid Faces

Flat 2 PC D/F Body w/ Flat 2" Retainer

Part #2009
K2009/47

Part #2047

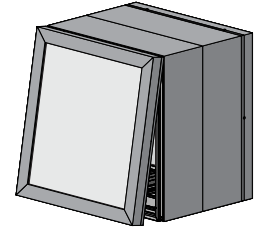
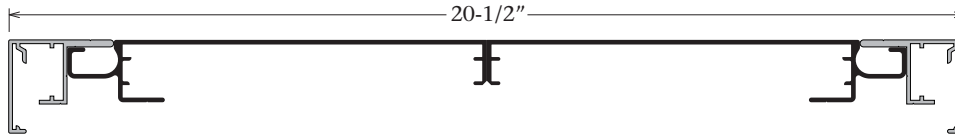

Size H'xW'	Mill Finish	Size H'xW'	Mill Finish	Size H'xW'	Mill Finish	Size H'xW'	Mill Finish
2 x 3	\$667	4 x 4	\$922	6 x 6	\$1259	8 x 14	\$2104
2 x 4	752	4 x 5	1006	6 x 7	1343	8 x 15	2187
2 x 5	837	4 x 6	1089	6 x 8	1427	8 x 16	2274
2 x 6	922	4 x 7	1174	6 x 9	1511	8 x 17	2358
2 x 7	1006	4 x 8	1260	6 x 10	1598	8 x 18	2442
2 x 8	1090	4 x 9	1344	6 x 11	1681	8 x 19	2527
2 x 9	1174	4 x 10	1430	6 x 12	1764	8 x 20	2612
2 x 10	1260	4 x 11	1513	6 x 13	1850		
2 x 11	1344	4 x 12	1598	6 x 14	1935	9 x 9	1764
2 x 12	1427	4 x 13	1683	6 x 15	2020	9 x 10	1850
2 x 13	1513	4 x 14	1767	6 x 16	2104	9 x 11	1935
2 x 14	1598	4 x 15	1850	6 x 17	2190	9 x 12	2018
2 x 15	1681	4 x 16	1937	6 x 18	2274	9 x 13	2104
2 x 16	1767	4 x 17	2021	6 x 19	2358	9 x 14	2187
2 x 17	1853	4 x 18	2105	6 x 20	2442	9 x 15	2273
2 x 18	1937	4 x 19	2190			9 x 16	2357
2 x 19	2021	4 x 20	2275	7 x 7	1427	9 x 17	2442
2 x 20	2105			7 x 8	1513	9 x 18	2527
		5 x 5	1089	7 x 9	1598	9 x 19	2612
3 x 3	750	5 x 6	1174	7 x 10	1681	9 x 20	2695
3 x 4	836	5 x 7	1259	7 x 11	1767		
3 x 5	922	5 x 8	1344	7 x 12	1850	10 x 10	1935
3 x 6	1006	5 x 9	1427	7 x 13	1937	10 x 11	2020
3 x 7	1089	5 x 10	1513	7 x 14	2020	10 x 12	2104
3 x 8	1174	5 x 11	1598	7 x 15	2104	10 x 13	2190
3 x 9	1259	5 x 12	1681	7 x 16	2190	10 x 14	2274
3 x 10	1344	5 x 13	1767	7 x 17	2274	10 x 15	2357
3 x 11	1427	5 x 14	1850	7 x 18	2358	10 x 16	2442
3 x 12	1511	5 x 15	1935	7 x 19	2442	10 x 17	2527
3 x 13	1598	5 x 16	2020	7 x 20	2528	10 x 18	2612
3 x 14	1681	5 x 17	2105			10 x 19	2695
3 x 15	1767	5 x 18	2190	8 x 8	1598	10 x 20	2781
3 x 16	1850	5 x 19	2274	8 x 9	1681		
3 x 17	1937	5 x 20	2358	8 x 10	1767		
3 x 18	2020			8 x 11	1850		
3 x 19	2105			8 x 12	1935		
3 x 20	2190			8 x 13	2020		

Kits Include:

- Mill Finish
- Cut to size and mitered bodies
- Cut to size and mitered retainers
- All screws required to assemble by mechanical fastening
- All Corner Angles and/or Corner Keys required
- Packaging

Not Included in Kits:

- Faces
- Electrical Components
- Divider(s) - See optional accessories
- Internal Supports
- Removable retainer option

Optional Accessories (pg 127):

- Divider(s)

Kit Specifications:

- It is recommended to order kits 1" over nominal T12 or T8 lamp size to utilize .040 flat Aluminum Raceway Covers
- Custom size kits may be cut to any dimension
- For Rigid Plastic or Flush Aluminum Faces

Recommended Lamp Spacing:

- For illuminated backgrounds - 12" on center, using T12 or T8 lamps

Divider Kits Includes:

- Cut to size dividers
- Mounting Brackets
- All screws required to assemble by mechanical fastening
- Flat 2" Divider, Part #2130, \$8.96 per/ft per/face

Additional Information (pgs 196-197)

Note: All dimensions are subject to the tolerance standards of the aluminum extrusion industry. Profile drawings are illustrative and rounded to the nearest 1/16".

**CURRENT PRICE as
of April 1, 2022**



COMMERCIAL

Unassembled Retro Kits w/out Reveal - For Pan Form Faces

Flat Retro Body w/ Flat Bleed Rigid Retainer

Part #2041
K2041/04

Part #2204

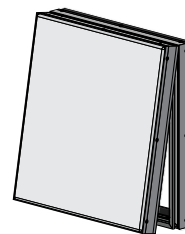
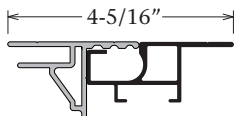

Size H'xW'	Mill Finish	Size H'xW'	Mill Finish	Size H'xW'	Mill Finish	Size H'xW'	Mill Finish
2 x 3	\$201	4 x 4	\$273	6 x 6	\$365	8 x 14	\$601
2 x 4	225	4 x 5	294	6 x 7	389	8 x 15	626
2 x 5	249	4 x 6	318	6 x 8	413	8 x 16	649
2 x 6	273	4 x 7	341	6 x 9	437	8 x 17	673
2 x 7	294	4 x 8	365	6 x 10	460	8 x 18	697
2 x 8	318	4 x 9	389	6 x 11	484	8 x 19	720
2 x 9	341	4 x 10	413	6 x 12	507	8 x 20	744
2 x 10	367	4 x 11	437	6 x 13	532		
2 x 11	389	4 x 12	460	6 x 14	554	9 x 9	507
2 x 12	413	4 x 13	484	6 x 15	578	9 x 10	532
2 x 13	437	4 x 14	507	6 x 16	602	9 x 11	554
2 x 14	460	4 x 15	532	6 x 17	626	9 x 12	578
2 x 15	484	4 x 16	554	6 x 18	649	9 x 13	601
2 x 16	508	4 x 17	578	6 x 19	673	9 x 14	626
2 x 17	532	4 x 18	602	6 x 20	697	9 x 15	649
2 x 18	554	4 x 19	626			9 x 16	673
2 x 19	578	4 x 20	649	7 x 7	413	9 x 17	697
2 x 20	602			7 x 8	437	9 x 18	720
		5 x 5	318	7 x 9	460	9 x 19	744
3 x 3	225	5 x 6	341	7 x 10	484	9 x 20	768
3 x 4	249	5 x 7	365	7 x 11	507		
3 x 5	273	5 x 8	389	7 x 12	532	10 x 10	554
3 x 6	294	5 x 9	413	7 x 13	554	10 x 11	578
3 x 7	318	5 x 10	437	7 x 14	578	10 x 12	601
3 x 8	341	5 x 11	460	7 x 15	602	10 x 13	626
3 x 9	367	5 x 12	484	7 x 16	626	10 x 14	649
3 x 10	389	5 x 13	507	7 x 17	649	10 x 15	673
3 x 11	413	5 x 14	532	7 x 18	673	10 x 16	697
3 x 12	437	5 x 15	554	7 x 19	697	10 x 17	720
3 x 13	460	5 x 16	578	7 x 20	720	10 x 18	744
3 x 14	484	5 x 17	602			10 x 19	768
3 x 15	508	5 x 18	626	8 x 8	460	10 x 20	789
3 x 16	532	5 x 19	649	8 x 9	484		
3 x 17	554	5 x 20	673	8 x 10	507		
3 x 18	578			8 x 11	532		
3 x 19	602			8 x 12	554		
3 x 20	626			8 x 13	578		

Kits Include:

- Mill Finish
- Cut to size and mitered bodies
- Cut to size and mitered retainers
- All screws required to assemble by mechanical fastening
- All Corner Angles and/or Corner Keys required
- Face attachment hardware
- Packaging
- Prices reflect one (1) Flat Retro Body kit, SINGLE FACE APPLICATION

Not Included in Kits:

- Face
- Electrical Components
- Divider(s) - See optional accessories
- Mounting Provisions
- Channel Letter Raceway U-Channel - See optional accessories
- Compression Gasket - See optional accessories

Optional Accessories (pg 127):

- Divider(s)
- Channel Letter Raceway U-Channel
- Compression Gasket

Kit Specifications:

- Kits will be cut .325" larger to fit over the existing structure
- Custom size kits may be cut to any dimension
- Illumination may vary depending on application

Additional Information (pgs 196-197)

Note: It is recommended to use safety chains and prop-bars on all hingeable faces.

Unassembled Single Face Kits w/out Reveal - For Pan Form Faces

Flat Wall Mount Retro Body w/ Flat Bleed Rigid Retainer

Part #2042
K2042/04

Part #2204

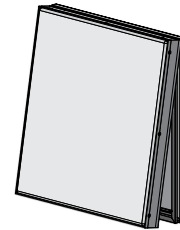
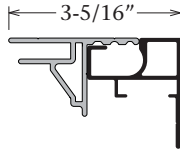

Size H'xW'	Mill Finish	Size H'xW'	Mill Finish	Size H'xW'	Mill Finish	Size H'xW'	Mill Finish
2 x 3	\$192	4 x 4	\$261	6 x 6	\$352	8 x 14	\$576
2 x 4	215	4 x 5	282	6 x 7	372	8 x 15	599
2 x 5	238	4 x 6	306	6 x 8	396	8 x 16	622
2 x 6	261	4 x 7	328	6 x 9	417	8 x 17	645
2 x 7	282	4 x 8	352	6 x 10	441	8 x 18	667
2 x 8	306	4 x 9	372	6 x 11	463	8 x 19	689
2 x 9	328	4 x 10	396	6 x 12	487	8 x 20	710
2 x 10	352	4 x 11	417	6 x 13	508		
2 x 11	372	4 x 12	441	6 x 14	532	9 x 9	487
2 x 12	396	4 x 13	463	6 x 15	552	9 x 10	508
2 x 13	417	4 x 14	487	6 x 16	576	9 x 11	532
2 x 14	441	4 x 15	508	6 x 17	599	9 x 12	552
2 x 15	463	4 x 16	532	6 x 18	622	9 x 13	576
2 x 16	487	4 x 17	552	6 x 19	645	9 x 14	599
2 x 17	508	4 x 18	576	6 x 20	667	9 x 15	622
2 x 18	532	4 x 19	599			9 x 16	645
2 x 19	552	4 x 20	622	7 x 7	396	9 x 17	667
2 x 20	576			7 x 8	417	9 x 18	689
		5 x 5	306	7 x 9	441	9 x 19	710
3 x 3	215	5 x 6	328	7 x 10	463	9 x 20	734
3 x 4	238	5 x 7	352	7 x 11	487		
3 x 5	261	5 x 8	372	7 x 12	508	10 x 10	532
3 x 6	282	5 x 9	396	7 x 13	532	10 x 11	552
3 x 7	306	5 x 10	417	7 x 14	552	10 x 12	576
3 x 8	328	5 x 11	441	7 x 15	576	10 x 13	598
3 x 9	352	5 x 12	463	7 x 16	599	10 x 14	622
3 x 10	372	5 x 13	487	7 x 17	622	10 x 15	645
3 x 11	396	5 x 14	508	7 x 18	645	10 x 16	667
3 x 12	417	5 x 15	532	7 x 19	667	10 x 17	689
3 x 13	441	5 x 16	552	7 x 20	689	10 x 18	710
3 x 14	463	5 x 17	576			10 x 19	734
3 x 15	487	5 x 18	599	8 x 8	441	10 x 20	755
3 x 16	508	5 x 19	622	8 x 9	463		
3 x 17	532	5 x 20	645	8 x 10	487		
3 x 18	552			8 x 11	508		
3 x 19	576			8 x 12	532		
3 x 20	599			8 x 13	552		

Kits Include:

- Mill Finish
- Cut to size and mitered bodies
- Cut to size and mitered retainers
- All screws required to assemble by mechanical fastening
- All Corner Angles and/or Corner Keys required
- Face attachment hardware
- Packaging

Not Included in Kits:

- Face or Back
- Electrical Components
- Back Braces and Gussets
- Mounting Provisions
- Channel Letter Raceway U-Channel - See optional accessories
- Compression Gasket - See optional accessories

Optional Accessories (pg 127):

- Channel Letter Raceway U-Channel
- Compression Gasket

Kit Specifications:

- **Recommended for LED applications**
- Custom size kits may be cut to any dimensions

Additional Information (pgs 196-197)

Note: All dimensions are subject to the tolerance standards of the aluminum extrusion industry. Profile drawings are illustrative and rounded to the nearest 1/16".

CURRENT PRICE as of April 1, 2022



COMMERCIAL

Unassembled Single Face Kits w/out Reveal - For Pan Form Faces

Flat S/F Body w/ Flat Bleed Rigid Retainer

Part #2027
K2027/04

Part #2204

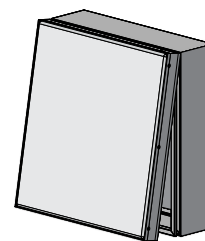
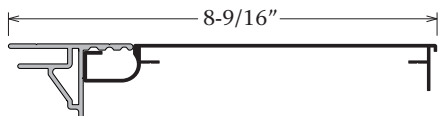

Size H'xW'	Mill Finish	Size H'xW'	Mill Finish	Size H'xW'	Mill Finish	Size H'xW'	Mill Finish
2 x 3	\$245	4 x 4	\$322	6 x 6	\$431	8 x 14	\$698
2 x 4	270	4 x 5	350	6 x 7	457	8 x 15	724
2 x 5	296	4 x 6	377	6 x 8	484	8 x 16	750
2 x 6	322	4 x 7	403	6 x 9	510	8 x 17	778
2 x 7	350	4 x 8	431	6 x 10	536	8 x 18	805
2 x 8	377	4 x 9	457	6 x 11	564	8 x 19	831
2 x 9	403	4 x 10	484	6 x 12	591	8 x 20	859
2 x 10	431	4 x 11	510	6 x 13	617	9 x 9	591
2 x 11	457	4 x 12	536	6 x 14	643	9 x 10	617
2 x 12	484	4 x 13	564	6 x 15	671	9 x 11	643
2 x 13	510	4 x 14	591	6 x 16	698	9 x 12	671
2 x 14	536	4 x 15	617	6 x 17	724	9 x 13	698
2 x 15	564	4 x 16	643	6 x 18	750	9 x 14	724
2 x 16	591	4 x 17	671	6 x 19	778	9 x 15	750
2 x 17	617	4 x 18	698	6 x 20	805	9 x 16	778
2 x 18	643	4 x 19	724	7 x 7	484	9 x 17	805
2 x 19	671	4 x 20	750	7 x 8	510	9 x 18	831
2 x 20	698			7 x 9	536	9 x 19	859
		5 x 5	377	7 x 10	564	9 x 20	885
3 x 3	270	5 x 6	403	7 x 11	591	10 x 10	643
3 x 4	296	5 x 7	431	7 x 12	617	10 x 11	671
3 x 5	322	5 x 8	457	7 x 13	643	10 x 12	698
3 x 6	350	5 x 9	484	7 x 14	671	10 x 13	724
3 x 7	377	5 x 10	510	7 x 15	698	10 x 14	750
3 x 8	403	5 x 11	536	7 x 16	724	10 x 15	778
3 x 9	431	5 x 12	564	7 x 17	750	10 x 16	805
3 x 10	457	5 x 13	591	7 x 18	778	10 x 17	831
3 x 11	484	5 x 14	617	7 x 19	805	10 x 18	859
3 x 12	510	5 x 15	643	7 x 20	831	10 x 19	885
3 x 13	536	5 x 16	671	8 x 8	536	10 x 20	911
3 x 14	564	5 x 17	698	8 x 9	564		
3 x 15	591	5 x 18	724	8 x 10	591		
3 x 16	617	5 x 19	750	8 x 11	617		
3 x 17	643	5 x 20	778	8 x 12	643		
3 x 18	671			8 x 13	671		
3 x 19	698						
3 x 20	724						

Kits Include:

- Mill Finish
- Cut to size and mitered bodies
- Cut to size and mitered retainers
- All screws required to assemble by mechanical fastening
- All Corner Angles and/or Corner Keys required
- Face attachment hardware
- Packaging

Not Included in Kits:

- Face or Back
- Electrical Components
- Back Braces and Gussets
- Mounting Provisions

Kit Specifications:

- It is recommended to order kits 1" over nominal T12 or T8 lamp size to utilize .040 flat Aluminum Raceway Covers
- Custom size kits may be cut to any dimension

Recommended Lamp Spacing:

- For illuminated backgrounds - 12" on center, using T12 or T8 lamps
- Always place lamps 3/4" from back of sign

Additional Information (pgs 196-197)

Note: It is recommended to use safety chains and prop-bars on all hingeable faces.

Unassembled Double Face Kits w/out Reveal - For Pan Form Faces

Flat D/F Medium Body w/ Flat Bleed Rigid Retainer

Part #2007
K2007/04

Part #2204

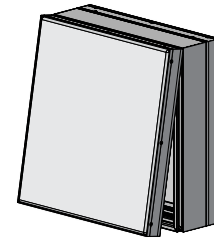
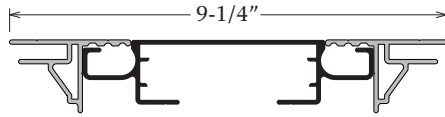

Size H'xW'	Mill Finish	Size H'xW'	Mill Finish	Size H'xW'	Mill Finish	Size H'xW'	Mill Finish
2 x 3	\$468	4 x 4	\$618	6 x 6	\$816	8 x 14	\$1315
2 x 4	516	4 x 5	664	6 x 7	865	8 x 15	1362
2 x 5	567	4 x 6	718	6 x 8	914	8 x 16	1413
2 x 6	618	4 x 7	769	6 x 9	966	8 x 17	1462
2 x 7	666	4 x 8	816	6 x 10	1015	8 x 18	1511
2 x 8	718	4 x 9	865	6 x 11	1066	8 x 19	1561
2 x 9	769	4 x 10	914	6 x 12	1116	8 x 20	1611
2 x 10	816	4 x 11	966	6 x 13	1165		
2 x 11	867	4 x 12	1015	6 x 14	1213	9 x 9	1116
2 x 12	914	4 x 13	1066	6 x 15	1265	9 x 10	1164
2 x 13	966	4 x 14	1116	6 x 16	1315	9 x 11	1213
2 x 14	1015	4 x 15	1165	6 x 17	1362	9 x 12	1265
2 x 15	1066	4 x 16	1213	6 x 18	1413	9 x 13	1315
2 x 16	1116	4 x 17	1265	6 x 19	1462	9 x 14	1362
2 x 17	1165	4 x 18	1315	6 x 20	1511	9 x 15	1413
2 x 18	1213	4 x 19	1362			9 x 16	1462
2 x 19	1265	4 x 20	1413	7 x 7	914	9 x 17	1511
2 x 20	1315			7 x 8	966	9 x 18	1561
		5 x 5	718	7 x 9	1015	9 x 19	1611
3 x 3	516	5 x 6	769	7 x 10	1066	9 x 20	1657
3 x 4	567	5 x 7	816	7 x 11	1116		
3 x 5	618	5 x 8	865	7 x 12	1165	10 x 10	1213
3 x 6	666	5 x 9	914	7 x 13	1213	10 x 11	1265
3 x 7	718	5 x 10	966	7 x 14	1265	10 x 12	1315
3 x 8	769	5 x 11	1015	7 x 15	1315	10 x 13	1362
3 x 9	816	5 x 12	1066	7 x 16	1362	10 x 14	1413
3 x 10	867	5 x 13	1116	7 x 17	1413	10 x 15	1462
3 x 11	914	5 x 14	1165	7 x 18	1462	10 x 16	1511
3 x 12	966	5 x 15	1213	7 x 19	1511	10 x 17	1561
3 x 13	1015	5 x 16	1265	7 x 20	1561	10 x 18	1609
3 x 14	1066	5 x 17	1315			10 x 19	1657
3 x 15	1116	5 x 18	1362	8 x 8	1015	10 x 20	1709
3 x 16	1165	5 x 19	1413	8 x 9	1066		
3 x 17	1213	5 x 20	1462	8 x 10	1116		
3 x 18	1265			8 x 11	1164		
3 x 19	1315			8 x 12	1213		
3 x 20	1362			8 x 13	1265		

Kits Include:

- Mill Finish
- Cut to size and mitered bodies
- Cut to size and mitered retainers
- All screws required to assemble by mechanical fastening
- All Corner Angles and/or Corner Keys required
- Face attachment hardware
- Packaging

Not Included in Kits:

- Faces
- Electrical Components
- Internal Supports

Kit Specifications:

- It is recommended to order kits 1" over nominal T12 or T8 lamp size to utilize .040 flat Aluminum Raceway Covers
- Custom size kits may be cut to any dimension

Recommended Lamp Spacing:

- For illuminated backgrounds - 12" on center, using T12 or T8 lamps

Additional Information (pgs 196-197)

Note: All dimensions are subject to the tolerance standards of the aluminum extrusion industry. Profile drawings are illustrative and rounded to the nearest 1/16".

**CURRENT PRICE as
of April 1, 2022**



COMMERCIAL

Unassembled Double Face Kits w/out Reveal - For Pan Form Faces

Flat D/F Body w/ Flat Bleed Rigid Retainer

Part #2008
K2008/04

Part #2204

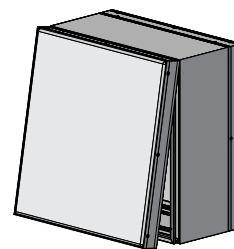
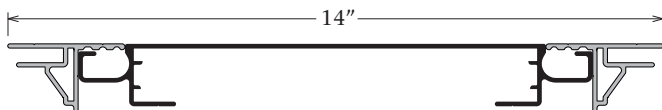

Size H'xW'	Mill Finish	Size H'xW'	Mill Finish	Size H'xW'	Mill Finish	Size H'xW'	Mill Finish
2 x 3	\$520	4 x 4	\$698	6 x 6	\$936	8 x 14	\$1537
2 x 4	579	4 x 5	758	6 x 7	998	8 x 15	1598
2 x 5	639	4 x 6	820	6 x 8	1057	8 x 16	1656
2 x 6	698	4 x 7	878	6 x 9	1116	8 x 17	1716
2 x 7	758	4 x 8	936	6 x 10	1176	8 x 18	1776
2 x 8	820	4 x 9	998	6 x 11	1237	8 x 19	1837
2 x 9	878	4 x 10	1057	6 x 12	1296	8 x 20	1895
2 x 10	936	4 x 11	1117	6 x 13	1356	9 x 9	1296
2 x 11	998	4 x 12	1176	6 x 14	1418	9 x 10	1356
2 x 12	1058	4 x 13	1237	6 x 15	1477	9 x 11	1416
2 x 13	1117	4 x 14	1296	6 x 16	1537	9 x 12	1477
2 x 14	1176	4 x 15	1356	6 x 17	1598	9 x 13	1537
2 x 15	1237	4 x 16	1418	6 x 18	1656	9 x 14	1598
2 x 16	1296	4 x 17	1477	6 x 19	1716	9 x 15	1656
2 x 17	1356	4 x 18	1537	6 x 20	1776	9 x 16	1716
2 x 18	1418	4 x 19	1598	7 x 7	1057	9 x 17	1776
2 x 19	1477	4 x 20	1656	7 x 8	1116	9 x 18	1837
2 x 20	1537	5 x 5	820	7 x 9	1176	9 x 19	1895
3 x 3	579	5 x 6	878	7 x 10	1237	9 x 20	1957
3 x 4	639	5 x 7	936	7 x 11	1296	10 x 10	1416
3 x 5	698	5 x 8	998	7 x 12	1356	10 x 11	1477
3 x 6	758	5 x 9	1057	7 x 13	1418	10 x 12	1537
3 x 7	820	5 x 10	1116	7 x 14	1477	10 x 13	1598
3 x 8	878	5 x 11	1176	7 x 15	1537	10 x 14	1656
3 x 9	936	5 x 12	1237	7 x 16	1598	10 x 15	1716
3 x 10	998	5 x 13	1296	7 x 17	1656	10 x 16	1776
3 x 11	1057	5 x 14	1356	7 x 18	1716	10 x 17	1837
3 x 12	1117	5 x 15	1418	7 x 19	1776	10 x 18	1895
3 x 13	1176	5 x 16	1477	7 x 20	1837	10 x 19	1957
3 x 14	1237	5 x 17	1537	8 x 8	1176	10 x 20	2013
3 x 15	1296	5 x 18	1598	8 x 9	1237		
3 x 16	1356	5 x 19	1656	8 x 10	1296		
3 x 17	1418	5 x 20	1716	8 x 11	1356		
3 x 18	1477			8 x 12	1416		
3 x 19	1537			8 x 13	1477		
3 x 20	1598						

Kits Include:

- Mill Finish
- Cut to size and mitered bodies
- Cut to size and mitered retainers
- All screws required to assemble by mechanical fastening
- All Corner Angles and/or Corner Keys required
- Face attachment hardware
- Packaging

Not Included in Kits:

- Faces
- Electrical Components
- Internal Supports

Kit Specifications:

- It is recommended to order kits 1" over nominal T12 or T8 lamp size to utilize .040 flat Aluminum Raceway Covers
- Custom size kits may be cut to any dimension

Recommended Lamp Spacing:

- For illuminated backgrounds - 12" on center, using T12 or T8 lamps

Additional Information (pgs 196-197)

Note: It is recommended to use safety chains and prop-bars on all hingeable faces.

Unassembled Double Face Kits w/out Reveal - For Pan Form Faces

Flat 2 PC D/F Medium Body w/ Flat Bleed Rigid Retainer

Part #2010
K2010/04

Part #2204

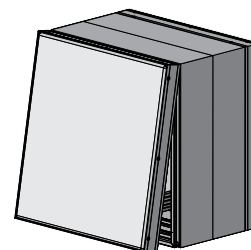
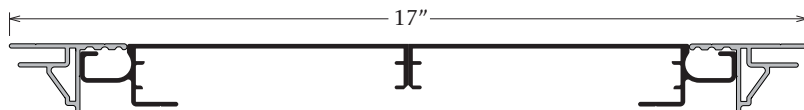

Size H'xW'	Mill Finish	Size H'xW'	Mill Finish	Size H'xW'	Mill Finish	Size H'xW'	Mill Finish
2 x 3	\$571	4 x 4	\$767	6 x 6	\$1027	8 x 14	\$1681
2 x 4	638	4 x 5	831	6 x 7	1092	8 x 15	1746
2 x 5	701	4 x 6	897	6 x 8	1158	8 x 16	1812
2 x 6	767	4 x 7	962	6 x 9	1223	8 x 17	1879
2 x 7	831	4 x 8	1027	6 x 10	1288	8 x 18	1941
2 x 8	897	4 x 9	1092	6 x 11	1354	8 x 19	2008
2 x 9	962	4 x 10	1158	6 x 12	1419	8 x 20	2073
2 x 10	1027	4 x 11	1223	6 x 13	1485		
2 x 11	1092	4 x 12	1288	6 x 14	1549	9 x 9	1419
2 x 12	1158	4 x 13	1354	6 x 15	1614	9 x 10	1483
2 x 13	1223	4 x 14	1419	6 x 16	1681	9 x 11	1549
2 x 14	1288	4 x 15	1485	6 x 17	1746	9 x 12	1614
2 x 15	1354	4 x 16	1549	6 x 18	1812	9 x 13	1681
2 x 16	1419	4 x 17	1616	6 x 19	1879	9 x 14	1746
2 x 17	1485	4 x 18	1681	6 x 20	1942	9 x 15	1812
2 x 18	1549	4 x 19	1746			9 x 16	1879
2 x 19	1616	4 x 20	1812	7 x 7	1158	9 x 17	1941
2 x 20	1681			7 x 8	1223	9 x 18	2008
		5 x 5	897	7 x 9	1288	9 x 19	2073
3 x 3	638	5 x 6	962	7 x 10	1354	9 x 20	2140
3 x 4	701	5 x 7	1027	7 x 11	1419		
3 x 5	767	5 x 8	1092	7 x 12	1485	10 x 10	1549
3 x 6	831	5 x 9	1158	7 x 13	1549	10 x 11	1614
3 x 7	897	5 x 10	1223	7 x 14	1614	10 x 12	1681
3 x 8	962	5 x 11	1288	7 x 15	1681	10 x 13	1746
3 x 9	1027	5 x 12	1354	7 x 16	1746	10 x 14	1812
3 x 10	1092	5 x 13	1419	7 x 17	1812	10 x 15	1879
3 x 11	1158	5 x 14	1485	7 x 18	1879	10 x 16	1941
3 x 12	1223	5 x 15	1549	7 x 19	1942	10 x 17	2008
3 x 13	1288	5 x 16	1616	7 x 20	2008	10 x 18	2073
3 x 14	1354	5 x 17	1681			10 x 19	2140
3 x 15	1419	5 x 18	1746	8 x 8	1288	10 x 20	2199
3 x 16	1485	5 x 19	1812	8 x 9	1354		
3 x 17	1549	5 x 20	1879	8 x 10	1419		
3 x 18	1616			8 x 11	1485		
3 x 19	1681			8 x 12	1549		
3 x 20	1746			8 x 13	1614		

Kits Include:

- Mill Finish
- Cut to size and mitered bodies
- Cut to size and mitered retainers
- All screws required to assemble by mechanical fastening
- All Corner Angles and/or Corner Keys required
- Face attachment hardware
- Packaging

Not Included in Kits:

- Faces
- Electrical Components
- Internal Supports

Kit Specifications:

- It is recommended to order kits 1" over nominal T12 or T8 lamp size to utilize .040 flat Aluminum Raceway Covers
- Custom size kits may be cut to any dimension

Recommended Lamp Spacing:

- For illuminated backgrounds - 12" on center, using T12 or T8 lamps

Additional Information (pgs 196-197)

Note: It is recommended to use safety chains and prop-bars on hingeable faces.

Note: All dimensions are subject to the tolerance standards of the aluminum extrusion industry. Profile drawings are illustrative and rounded to the nearest 1/16".

CURRENT PRICE as of April 1, 2022



COMMERCIAL

Unassembled Double Face Kits w/out Reveal - For Pan Form Faces

Flat 2 PC D/F Body w/ Flat Bleed Rigid Retainer

Part #2009
K2009/04

Part #2204

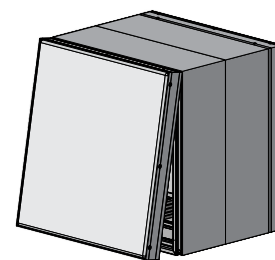
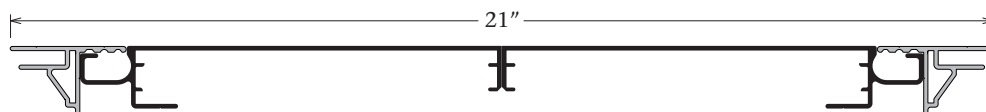

Size H'xW'	Mill Finish	Size H'xW'	Mill Finish	Size H'xW'	Mill Finish	Size H'xW'	Mill Finish
2 x 3	\$629	4 x 4	\$824	6 x 6	\$1137	8 x 14	\$1841
2 x 4	694	4 x 5	887	6 x 7	1202	8 x 15	1966
2 x 5	756	4 x 6	951	6 x 8	1268	8 x 16	2028
2 x 6	824	4 x 7	1015	6 x 9	1332	8 x 17	2092
2 x 7	887	4 x 8	1137	6 x 10	1395	8 x 18	2156
2 x 8	951	4 x 9	1202	6 x 11	1461	8 x 19	2278
2 x 9	1015	4 x 10	1268	6 x 12	1526	8 x 20	2345
2 x 10	1137	4 x 11	1332	6 x 13	1586		
2 x 11	1202	4 x 12	1395	6 x 14	1712	9 x 9	1526
2 x 12	1268	4 x 13	1461	6 x 15	1776	9 x 10	1586
2 x 13	1332	4 x 14	1526	6 x 16	1841	9 x 11	1712
2 x 14	1395	4 x 15	1586	6 x 17	1966	9 x 12	1776
2 x 15	1461	4 x 16	1712	6 x 18	2028	9 x 13	1841
2 x 16	1526	4 x 17	1776	6 x 19	2092	9 x 14	1966
2 x 17	1586	4 x 18	1841	6 x 20	2156	9 x 15	2028
2 x 18	1712	4 x 19	1966			9 x 16	2092
2 x 19	1776	4 x 20	2028	7 x 7	1268	9 x 17	2156
2 x 20	1841			7 x 8	1332	9 x 18	2278
		5 x 5	951	7 x 9	1395	9 x 19	2345
3 x 3	694	5 x 6	1015	7 x 10	1461	9 x 20	2410
3 x 4	756	5 x 7	1137	7 x 11	1526		
3 x 5	824	5 x 8	1202	7 x 12	1586	10 x 10	1712
3 x 6	887	5 x 9	1268	7 x 13	1712	10 x 11	1776
3 x 7	951	5 x 10	1332	7 x 14	1776	10 x 12	1841
3 x 8	1015	5 x 11	1395	7 x 15	1841	10 x 13	1966
3 x 9	1137	5 x 12	1461	7 x 16	1966	10 x 14	2028
3 x 10	1202	5 x 13	1526	7 x 17	2028	10 x 15	2092
3 x 11	1268	5 x 14	1586	7 x 18	2092	10 x 16	2156
3 x 12	1332	5 x 15	1712	7 x 19	2156	10 x 17	2278
3 x 13	1395	5 x 16	1776	7 x 20	2278	10 x 18	2345
3 x 14	1461	5 x 17	1841			10 x 19	2410
3 x 15	1526	5 x 18	1966	8 x 8	1395	10 x 20	2477
3 x 16	1586	5 x 19	2028	8 x 9	1458		
3 x 17	1712	5 x 20	2092	8 x 10	1526		
3 x 18	1776			8 x 11	1586		
3 x 19	1841			8 x 12	1712		
3 x 20	1966			8 x 13	1776		

Kits Include:

- Mill Finish
- Cut to size and mitered bodies
- Cut to size and mitered retainers
- All screws required to assemble by mechanical fastening
- All Corner Angles and/or Corner Keys required
- Face attachment hardware
- Packaging

Not Included in Kits:

- Faces
- Electrical Components
- Internal Supports

Kit Specifications:

- It is recommended to order kits 1" over nominal T12 or T8 lamp size to utilize .040 flat Aluminum Raceway Covers
- Custom size kits may be cut to any dimension

Recommended Lamp Spacing:

- For illuminated backgrounds - 12" on center, using T12 or T8 lamps

Additional Information (pgs 196-197)

Note: It is recommended to use safety chains and prop-bars on hingeable faces.

Unassembled Retro Kits w/out Reveal - For Flexible Faces

Flat Retro Body w/ Flat Bleed Retro Frame II and Cover

Part #2041
K2041/2107/21

Part #2107

Part #2121

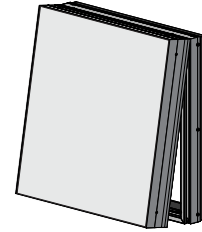
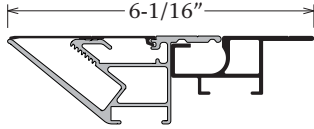

Size H'xW'	Mill Finish	Size H'xW'	Mill Finish	Size H'xW'	Mill Finish	Size H'xW'	Mill Finish
2 x 3	\$322	4 x 4	\$435	6 x 6	\$610	8 x 14	\$1037
2 x 4	361	4 x 5	474	6 x 7	660	8 x 15	1074
2 x 5	397	4 x 6	523	6 x 8	698	8 x 16	1111
2 x 6	447	4 x 7	571	6 x 9	734	8 x 17	1161
2 x 7	496	4 x 8	610	6 x 10	784	8 x 18	1197
2 x 8	535	4 x 9	646	6 x 11	824	8 x 19	1248
2 x 9	571	4 x 10	698	6 x 12	860	8 x 20	1285
2 x 10	623	4 x 11	734	6 x 13	911		
2 x 11	660	4 x 12	776	6 x 14	947	9 x 9	860
2 x 12	699	4 x 13	824	6 x 15	985	9 x 10	911
2 x 13	746	4 x 14	860	6 x 16	1037	9 x 11	947
2 x 14	788	4 x 15	899	6 x 17	1074	9 x 12	985
2 x 15	824	4 x 16	947	6 x 18	1111	9 x 13	1037
2 x 16	872	4 x 17	985	6 x 19	1161	9 x 14	1074
2 x 17	911	4 x 18	1025	6 x 20	1197	9 x 15	1111
2 x 18	947	4 x 19	1074			9 x 16	1161
2 x 19	997	4 x 20	1111	7 x 7	709	9 x 17	1197
2 x 20	1037			7 x 8	746	9 x 18	1235
		5 x 5	511	7 x 9	784	9 x 19	1285
3 x 3	361	5 x 6	560	7 x 10	836	9 x 20	1325
3 x 4	397	5 x 7	610	7 x 11	872		
3 x 5	435	5 x 8	646	7 x 12	911	10 x 10	959
3 x 6	485	5 x 9	685	7 x 13	959	10 x 11	997
3 x 7	535	5 x 10	734	7 x 14	997	10 x 12	1037
3 x 8	571	5 x 11	773	7 x 15	1037	10 x 13	1086
3 x 9	610	5 x 12	812	7 x 16	1086	10 x 14	1122
3 x 10	660	5 x 13	860	7 x 17	1122	10 x 15	1161
3 x 11	698	5 x 14	899	7 x 18	1161	10 x 16	1211
3 x 12	734	5 x 15	935	7 x 19	1211	10 x 17	1248
3 x 13	788	5 x 16	985	7 x 20	1248	10 x 18	1285
3 x 14	824	5 x 17	1025			10 x 19	1336
3 x 15	860	5 x 18	1063	8 x 8	784	10 x 20	1372
3 x 16	911	5 x 19	1111	8 x 9	824		
3 x 17	947	5 x 20	1149	8 x 10	860		
3 x 18	985			8 x 11	911		
3 x 19	1037			8 x 12	947		
3 x 20	1074			8 x 13	985		

Kits Include:

- Mill Finish
- Cut to size and mitered bodies
- Cut to size and mitered frames with covers
- Tension Clips
- Frame Braces for LED applications (Part #5357)
- All screws required to assemble by mechanical fastening
- All Corner Angles and/or Corner Keys required
- Packaging
- Prices reflect one (1) Flat Retro Body kit, SINGLE FACE APPLICATION

Not Included in Kits:

- Face
- Electrical Components
- Frame Support Tube - See optional accessories
- Tension Tool - See optional accessories
- Mounting Provisions
- Channel Letter Raceway U-Channel - See optional accessories

Optional Accessories (pg 127):

- Frame Support Tube
- Tension Tool
- Channel Letter Raceway U-Channel
- Compression Gasket

Kit Specifications:

- Kits will be cut .325" larger to fit over the existing structure
- Custom size kits may be cut to any dimension
- Flexible face preparation - See page 129
- Frame Brace / Frame Support Tube placement - See page 130
- Illumination may vary depending on application

Additional Information (pgs 196-197)



Note: All dimensions are subject to the tolerance standards of the aluminum extrusion industry. Profile drawings are illustrative and rounded to the nearest 1/16".

**CURRENT PRICE as
of April 1, 2022**



COMMERCIAL

Unassembled Single Face Kits w/out Reveal - For Flexible Faces

Flat Wall Mount Retro Body w/ Flat Bleed Retro Frame II and Cover

Part #2042
K2042/2107/21

Part #2107

Part #2121

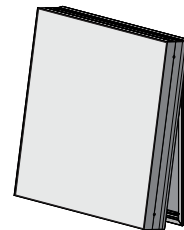
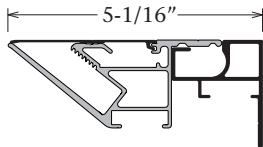

Size H'xW'	Mill Finish	Size H'xW'	Mill Finish	Size H'xW'	Mill Finish	Size H'xW'	Mill Finish
2 x 3	\$312	4 x 4	\$419	6 x 6	\$564	8 x 14	\$928
2 x 4	348	4 x 5	456	6 x 7	599	8 x 15	964
2 x 5	384	4 x 6	492	6 x 8	638	8 x 16	1002
2 x 6	419	4 x 7	528	6 x 9	673	8 x 17	1038
2 x 7	456	4 x 8	564	6 x 10	709	8 x 18	1071
2 x 8	492	4 x 9	599	6 x 11	746	8 x 19	1110
2 x 9	528	4 x 10	638	6 x 12	781	8 x 20	1145
2 x 10	564	4 x 11	673	6 x 13	820		
2 x 11	599	4 x 12	709	6 x 14	855	9 x 9	781
2 x 12	638	4 x 13	746	6 x 15	890	9 x 10	820
2 x 13	673	4 x 14	781	6 x 16	928	9 x 11	855
2 x 14	709	4 x 15	820	6 x 17	964	9 x 12	890
2 x 15	746	4 x 16	855	6 x 18	1002	9 x 13	928
2 x 16	781	4 x 17	890	6 x 19	1038	9 x 14	964
2 x 17	820	4 x 18	928	6 x 20	1071	9 x 15	1002
2 x 18	855	4 x 19	964			9 x 16	1038
2 x 19	890	4 x 20	1002	7 x 7	638	9 x 17	1071
2 x 20	928			7 x 8	673	9 x 18	1110
		5 x 5	492	7 x 9	709	9 x 19	1145
		5 x 6	528	7 x 10	746	9 x 20	1181
		5 x 7	564	7 x 11	781		
		5 x 8	599	7 x 12	820	10 x 10	855
		5 x 9	638	7 x 13	855	10 x 11	890
		5 x 10	673	7 x 14	890	10 x 12	928
		5 x 11	709	7 x 15	928	10 x 13	964
		5 x 12	746	7 x 16	964	10 x 14	1002
		5 x 13	781	7 x 17	1002	10 x 15	1038
		5 x 14	820	7 x 18	1038	10 x 16	1071
		5 x 15	855	7 x 19	1071	10 x 17	1110
		5 x 16	890	7 x 20	1110	10 x 18	1145
		5 x 17	928			10 x 19	1181
		5 x 18	964	8 x 8	709	10 x 20	1216
		5 x 19	1002	8 x 9	746		
		5 x 20	1038	8 x 10	781		
				8 x 11	820		
				8 x 12	855		
				8 x 13	890		

Kits Include:

- Mill Finish
- Cut to size and mitered bodies
- Cut to size and mitered frames with covers
- Tension Clips
- Frame Braces for LED applications (Part #5352)
- All screws required to assemble by mechanical fastening
- All Corner Angles and/or Corner Keys required
- Packaging

Not Included in Kits:

- Face or Back
- Electrical Component
- Back Braces and Gussets
- Frame Support Tube - See optional accessories
- Tension Tool - See optional accessories
- Mounting Provisions
- Channel Letter Raceway U-Channel - See optional accessories
- Compression Gasket - See optional accessories

Optional Accessories (pg 127):

- Frame Support Tube
- Tension Tool
- Channel Letter Raceway U-Channel
- Compression Gasket

Kit Specifications:

- **Recommended for LED applications**
- Custom size kits may be cut to any dimension
- Flexible face preparation - See page 129
- Frame Brace / Frame Support Tube placement - See page 130

Additional Information (pgs 196-197)

UL Recognized Component Systems
The Underwriters Laboratory file number is E136850

Note: It is recommended to use safety chains and prop-bars on all hingeable faces.

US Patent Numbers 9,208,701 / 6,061,941 / 6,637,080
CA Patent Numbers 2,245,623 / 2,387,222

Unassembled Single Face Kits w/out Reveal - For Flexible Faces

Flat S/F Body w/ Flat Bleed Retro Frame II and Cover

Part #2027
K2027/2107/21

Part #2107

Part #2121

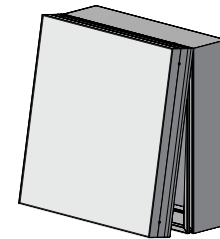
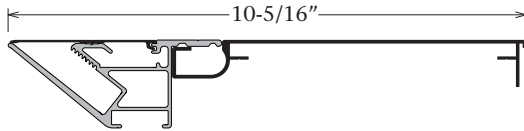

Size H'xW'	Mill Finish	Size H'xW'	Mill Finish	Size H'xW'	Mill Finish	Size H'xW'	Mill Finish
2 x 3	\$403	4 x 4	\$534	6 x 6	\$734	8 x 14	\$1232
2 x 4	445	4 x 5	578	6 x 7	792	8 x 15	1274
2 x 5	490	4 x 6	635	6 x 8	839	8 x 16	1318
2 x 6	546	4 x 7	690	6 x 9	883	8 x 17	1376
2 x 7	601	4 x 8	734	6 x 10	936	8 x 18	1421
2 x 8	646	4 x 9	778	6 x 11	983	8 x 19	1478
2 x 9	690	4 x 10	839	6 x 12	1027	8 x 20	1523
2 x 10	746	4 x 11	883	6 x 13	1085	9 x 9	1027
2 x 11	790	4 x 12	924	6 x 14	1129	9 x 10	1085
2 x 12	837	4 x 13	983	6 x 15	1173	9 x 11	1129
2 x 13	892	4 x 14	1027	6 x 16	1232	9 x 12	1173
2 x 14	935	4 x 15	1073	6 x 17	1274	9 x 13	1232
2 x 15	982	4 x 16	1129	6 x 18	1318	9 x 14	1274
2 x 16	1038	4 x 17	1173	6 x 19	1376	9 x 15	1318
2 x 17	1083	4 x 18	1220	6 x 20	1421	9 x 16	1376
2 x 18	1128	4 x 19	1274	7 x 7	851	9 x 17	1421
2 x 19	1183	4 x 20	1318	7 x 8	895	9 x 18	1465
2 x 20	1229			7 x 9	936	9 x 19	1523
		5 x 5	623	7 x 10	995	9 x 20	1569
3 x 3	445	5 x 6	678	7 x 11	1039		
3 x 4	490	5 x 7	734	7 x 12	1085	10 x 10	1141
3 x 5	534	5 x 8	778	7 x 13	1141	10 x 11	1184
3 x 6	590	5 x 9	825	7 x 14	1184	10 x 12	1232
3 x 7	646	5 x 10	883	7 x 15	1232	10 x 13	1285
3 x 8	690	5 x 11	924	7 x 16	1285	10 x 14	1330
3 x 9	734	5 x 12	972	7 x 17	1330	10 x 15	1376
3 x 10	790	5 x 13	1027	7 x 18	1376	10 x 16	1434
3 x 11	837	5 x 14	1073	7 x 19	1434	10 x 17	1478
3 x 12	881	5 x 15	1117	7 x 20	1478	10 x 18	1523
3 x 13	935	5 x 16	1173			10 x 19	1580
3 x 14	982	5 x 17	1220	8 x 8	936	10 x 20	1620
3 x 15	1026	5 x 18	1263	8 x 9	983		
3 x 16	1083	5 x 19	1318	8 x 10	1027		
3 x 17	1128	5 x 20	1364	8 x 11	1085		
3 x 18	1172			8 x 12	1129		
3 x 19	1229			8 x 13	1173		
3 x 20	1272						

Kits Include:

- Mill Finish
- Cut to size and mitered bodies
- Cut to size and mitered frames with covers
- Tension Clips
- Frame Braces for LED applications (Part #5357)
- All screws required to assemble by mechanical fastening
- All Corner Angles and/or Corner Keys required
- Packaging

Not Included in Kits:

- Face or Back
- Electrical Component
- Back Braces and Gussets
- Frame Support Tube - See optional accessories
- Tension Tool - See optional accessories
- Mounting Provisions

Optional Accessories (pg 127):

- Frame Support Tube
- Tension Tool

Kit Specifications:

- It is recommended to order kits 1" over nominal T12 or T8 lamp size to utilize .040 flat Aluminum Raceway Covers
- Custom size kits may be cut to any dimension
- Flexible face preparation - See page 129
- Frame Brace / Frame Support Tube placement - See page 130

Recommended Lamp Spacing:

- For illuminated backgrounds - 12" on center, using T12 or T8 lamps
- Always place lamps 3/4" from back of sign
- When using lamps, deduct \$5.11 per Frame Brace

Additional Information (pgs 196-197)



Note: All dimensions are subject to the tolerance standards of the aluminum extrusion industry. Profile drawings are illustrative and rounded to the nearest 1/16".

CURRENT PRICE as of April 1, 2022



COMMERCIAL

Unassembled Double Face Kits w/out Reveal - For Flexible Faces

Flat D/F Medium Body w/ Flat Bleed Retro Frame II and Cover

Part #2007
K2007/2107/21

Part #2107

Part #2121

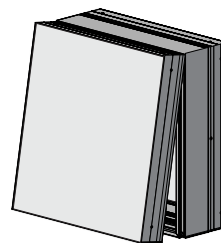
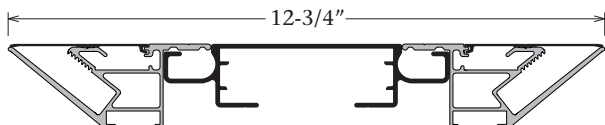

Size H'xW'	Mill Finish	Size H'xW'	Mill Finish	Size H'xW'	Mill Finish	Size H'xW'	Mill Finish
2 x 3	\$643	4 x 4	\$867	6 x 6	\$1168	8 x 14	\$1922
2 x 4	717	4 x 5	942	6 x 7	1243	8 x 15	1997
2 x 5	792	4 x 6	1018	6 x 8	1318	8 x 16	2073
2 x 6	867	4 x 7	1094	6 x 9	1394	8 x 17	2149
2 x 7	942	4 x 8	1168	6 x 10	1469	8 x 18	2222
2 x 8	1018	4 x 9	1243	6 x 11	1545	8 x 19	2297
2 x 9	1094	4 x 10	1318	6 x 12	1620	8 x 20	2374
2 x 10	1168	4 x 11	1394	6 x 13	1695	9 x 9	1620
2 x 11	1243	4 x 12	1469	6 x 14	1770	9 x 10	1695
2 x 12	1318	4 x 13	1545	6 x 15	1846	9 x 11	1770
2 x 13	1394	4 x 14	1620	6 x 16	1922	9 x 12	1846
2 x 14	1469	4 x 15	1695	6 x 17	1997	9 x 13	1922
2 x 15	1545	4 x 16	1770	6 x 18	2073	9 x 14	1997
2 x 16	1621	4 x 17	1846	6 x 19	2149	9 x 15	2073
2 x 17	1695	4 x 18	1922	6 x 20	2222	9 x 16	2149
2 x 18	1770	4 x 19	1997	7 x 7	1318	9 x 17	2222
2 x 19	1846	4 x 20	2073	7 x 8	1394	9 x 18	2297
2 x 20	1922	5 x 5	1018	7 x 9	1469	9 x 19	2374
3 x 3	717	5 x 6	1094	7 x 10	1545	9 x 20	2449
3 x 4	792	5 x 7	1168	7 x 11	1620	10 x 10	1770
3 x 5	867	5 x 8	1243	7 x 12	1695	10 x 11	1846
3 x 6	942	5 x 9	1318	7 x 13	1770	10 x 12	1922
3 x 7	1018	5 x 10	1394	7 x 14	1846	10 x 13	1997
3 x 8	1094	5 x 11	1469	7 x 15	1922	10 x 14	2073
3 x 9	1168	5 x 12	1545	7 x 16	1997	10 x 15	2149
3 x 10	1243	5 x 13	1620	7 x 17	2073	10 x 16	2221
3 x 11	1318	5 x 14	1695	7 x 18	2149	10 x 17	2297
3 x 12	1394	5 x 15	1770	7 x 19	2222	10 x 18	2374
3 x 13	1469	5 x 16	1846	7 x 20	2297	10 x 19	2449
3 x 14	1545	5 x 17	1922	8 x 8	1469	10 x 20	2517
3 x 15	1620	5 x 18	1997	8 x 9	1545		
3 x 16	1695	5 x 19	2073	8 x 10	1620		
3 x 17	1770	5 x 20	2149	8 x 11	1695		
3 x 18	1846			8 x 12	1770		
3 x 19	1922			8 x 13	1846		
3 x 20	1997						

Kits Include:

- Mill Finish
- Cut to size and mitered bodies
- Cut to size and mitered frames with covers
- Tension Clips
- Frame Braces for LED applications (Part #5350)
- All screws required to assemble by mechanical fastening
- All Corner Angles and/or Corner Keys required
- Packaging

Not Included in Kits:

- Faces
- Electrical Components
- Internal Supports
- Frame Support Tube - See optional accessories
- Tension Tool - See optional accessories

Optional Accessories (pg 127):

- Frame Support Tube
- Tension Tool

Kit Specifications:

- It is recommended to order kits 1" over nominal T12 or T8 lamp size to utilize .040 flat Aluminum Raceway Covers

- Custom size kits may be cut to any dimension
- Flexible face preparation - See page 129
- Frame Brace / Frame Support Tube placement - See page 130

Recommended Lamp Spacing:

- For illuminated backgrounds - 12" on center, using T12 or T8 lamps

Additional Information (pgs 196-197)

UL Recognized Component Systems
The Underwriters Laboratory file number is E136850

Note: It is recommended to use safety chains and prop-bars on all hingeable faces.

US Patent Numbers 6,061,941 / 6,637,080
CA Patent Numbers 2,245,623 / 2,387,222

Unassembled Double Face Kits w/out Reveal - For Flexible Faces

Flat D/F Body w/ Flat Bleed Retro Frame II and Cover

Part #2008
K2008/2107/21

Part #2107

Part #2121

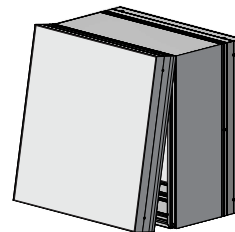
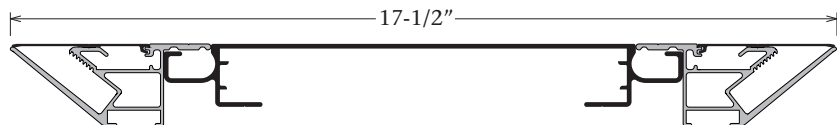

Size H'xW'	Mill Finish	Size H'xW'	Mill Finish	Size H'xW'	Mill Finish	Size H'xW'	Mill Finish
2 x 3	\$761	4 x 4	\$1025	6 x 6	\$1425	8 x 14	\$2405
2 x 4	849	4 x 5	1113	6 x 7	1540	8 x 15	2495
2 x 5	938	4 x 6	1225	6 x 8	1627	8 x 16	2582
2 x 6	1049	4 x 7	1339	6 x 9	1712	8 x 17	2699
2 x 7	1161	4 x 8	1426	6 x 10	1828	8 x 18	2782
2 x 8	1251	4 x 9	1516	6 x 11	1916	8 x 19	2895
2 x 9	1340	4 x 10	1627	6 x 12	2004	8 x 20	2984
2 x 10	1450	4 x 11	1712	6 x 13	2116		
2 x 11	1540	4 x 12	1803	6 x 14	2206	9 x 9	2004
2 x 12	1627	4 x 13	1916	6 x 15	2294	9 x 10	2116
2 x 13	1739	4 x 14	2004	6 x 16	2405	9 x 11	2206
2 x 14	1828	4 x 15	2093	6 x 17	2495	9 x 12	2294
2 x 15	1916	4 x 16	2206	6 x 18	2582	9 x 13	2405
2 x 16	2028	4 x 17	2294	6 x 19	2699	9 x 14	2495
2 x 17	2116	4 x 18	2382	6 x 20	2782	9 x 15	2582
2 x 18	2206	4 x 19	2495			9 x 16	2699
2 x 19	2318	4 x 20	2582	7 x 7	1652	9 x 17	2782
2 x 20	2405			7 x 8	1737	9 x 18	2872
		5 x 5	1202	7 x 9	1828	9 x 19	2984
3 x 3	849	5 x 6	1314	7 x 10	1940	9 x 20	3073
3 x 4	936	5 x 7	1425	7 x 11	2028		
3 x 5	1025	5 x 8	1516	7 x 12	2116	10 x 10	2230
3 x 6	1136	5 x 9	1604	7 x 13	2230	10 x 11	2318
3 x 7	1251	5 x 10	1712	7 x 14	2318	10 x 12	2405
3 x 8	1340	5 x 11	1803	7 x 15	2405	10 x 13	2520
3 x 9	1426	5 x 12	1891	7 x 16	2520	10 x 14	2607
3 x 10	1540	5 x 13	2004	7 x 17	2607	10 x 15	2699
3 x 11	1627	5 x 14	2093	7 x 18	2699	10 x 16	2806
3 x 12	1714	5 x 15	2183	7 x 19	2806	10 x 17	2895
3 x 13	1828	5 x 16	2294	7 x 20	2895	10 x 18	2984
3 x 14	1916	5 x 17	2382			10 x 19	3098
3 x 15	2004	5 x 18	2472	8 x 8	1828	10 x 20	3180
3 x 16	2116	5 x 19	2582	8 x 9	1917		
3 x 17	2206	5 x 20	2674	8 x 10	2004		
3 x 18	2294			8 x 11	2116		
3 x 19	2405			8 x 12	2206		
3 x 20	2495			8 x 13	2294		

Kits Include:

- Mill Finish
- Cut to size and mitered bodies
- Cut to size and mitered frames with covers
- Tension Clips
- Frame Braces for LED applications (Part #5357)
- All screws required to assemble by mechanical fastening
- All Corner Angles and/or Corner Keys required
- Packaging

Not Included in Kits:

- Faces
- Electrical Component
- Internal Supports
- Frame Support Tube - See optional accessories
- Tension Tool - See optional accessories

Optional Accessories (pg 127):

- Frame Support Tube
- Tension Tool

Kit Specifications:

- It is recommended to order kits 1" over nominal T12 or T8 lamp size to utilize .040 flat Aluminum Raceway Covers

- Custom size kits may be cut to any dimension
- Flexible face preparation - See page 129
- Frame Brace / Frame Support Tube placement - See page 130

Recommended Lamp Spacing:

- For illuminated backgrounds - 12" on center, using T12 or T8 lamps
- When using lamps, deduct \$5.11 per Frame Brace

Additional Information (pgs 196-197)

Note: All dimensions are subject to the tolerance standards of the aluminum extrusion industry. Profile drawings are illustrative and rounded to the nearest 1/16".

CURRENT PRICE as of April 1, 2022



COMMERCIAL

Unassembled Double Face Kits w/out Reveal - For Flexible Faces

Flat 2 PC D/F Medium Body w/ Flat Bleed Retro Frame II and Cover

Part #2010
K2010/2107/21

Part #2107

Part #2121

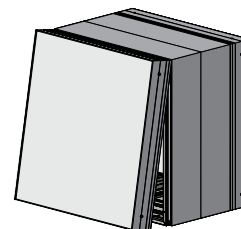
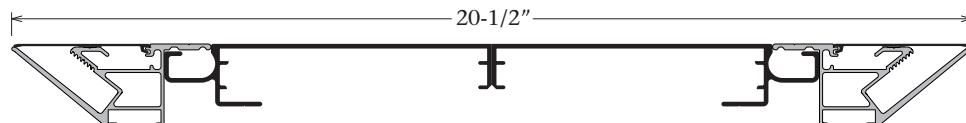

Size H'xW'	Mill Finish	Size H'xW'	Mill Finish	Size H'xW'	Mill Finish	Size H'xW'	Mill Finish
2 x 3	\$887	4 x 4	\$1186	6 x 6	\$1639	8 x 14	\$2747
2 x 4	985	4 x 5	1287	6 x 7	1763	8 x 15	2847
2 x 5	1086	4 x 6	1413	6 x 8	1865	8 x 16	2948
2 x 6	1209	4 x 7	1540	6 x 9	1965	8 x 17	3075
2 x 7	1335	4 x 8	1639	6 x 10	2091	8 x 18	3174
2 x 8	1439	4 x 9	1740	6 x 11	2191	8 x 19	3300
2 x 9	1540	4 x 10	1865	6 x 12	2293	8 x 20	3400
2 x 10	1663	4 x 11	1965	6 x 13	2419		
2 x 11	1763	4 x 12	2065	6 x 14	2520	9 x 9	2293
2 x 12	1865	4 x 13	2194	6 x 15	2623	9 x 10	2419
2 x 13	1989	4 x 14	2293	6 x 16	2747	9 x 11	2520
2 x 14	2091	4 x 15	2396	6 x 17	2848	9 x 12	2623
2 x 15	2194	4 x 16	2521	6 x 18	2948	9 x 13	2747
2 x 16	2317	4 x 17	2623	6 x 19	3075	9 x 14	2847
2 x 17	2419	4 x 18	2723	6 x 20	3174	9 x 15	2948
2 x 18	2521	4 x 19	2848			9 x 16	3075
2 x 19	2646	4 x 20	2948	7 x 7	1890	9 x 17	3174
2 x 20	2749			7 x 8	1989	9 x 18	3276
		5 x 5	1390	7 x 9	2091	9 x 19	3400
3 x 3	985	5 x 6	1514	7 x 10	2215	9 x 20	3505
3 x 4	1086	5 x 7	1639	7 x 11	2317		
3 x 5	1186	5 x 8	1740	7 x 12	2419	10 x 10	2543
3 x 6	1311	5 x 9	1841	7 x 13	2543	10 x 11	2644
3 x 7	1438	5 x 10	1965	7 x 14	2646	10 x 12	2747
3 x 8	1540	5 x 11	2065	7 x 15	2747	10 x 13	2872
3 x 9	1639	5 x 12	2168	7 x 16	2872	10 x 14	2972
3 x 10	1763	5 x 13	2293	7 x 17	2972	10 x 15	3075
3 x 11	1865	5 x 14	2396	7 x 18	3075	10 x 16	3197
3 x 12	1965	5 x 15	2497	7 x 19	3197	10 x 17	3300
3 x 13	2091	5 x 16	2623	7 x 20	3300	10 x 18	3400
3 x 14	2194	5 x 17	2723			10 x 19	3530
3 x 15	2293	5 x 18	2825	8 x 8	2091	10 x 20	3621
3 x 16	2419	5 x 19	2948	8 x 9	2191		
3 x 17	2521	5 x 20	3051	8 x 10	2293		
3 x 18	2623			8 x 11	2419		
3 x 19	2749			8 x 12	2520		
3 x 20	2848			8 x 13	2623		

Kits Include:

- Mill Finish
- Cut to size and mitered bodies
- Cut to size and mitered frames with covers
- Tension Clips
- Frame Braces for LED applications (Part #5357)
- All screws required to assemble by mechanical fastening
- All Corner Angles and/or Corner Keys required
- Packaging

Not Included in Kits:

- Faces
- Electrical Components
- Internal Supports
- Frame Support Tube - See optional accessories
- Tension Tool - See optional accessories

Optional Accessories (pg 127):

- Frame Support Tube
- Tension Tool

Kit Specifications:

- It is recommended to order kits 1" over nominal T12 or T8 lamp size to utilize .040 flat Aluminum Raceway Covers

- Custom size kits may be cut to any dimension
- Flexible face preparation - See page 129
- Frame Brace / Frame Support Tube placement - See page 130

Recommended Lamp Spacing:

- For illuminated backgrounds - 12" on center, using T12 or T8 lamps

Additional Information (pgs 196-197)

UL Recognized Component Systems
The Underwriters Laboratory file number is E136850

Note: It is recommended to use safety chains and prop-bars on all hingeable faces.

US Patent Numbers 6,061,941 / 6,637,080
CA Patent Numbers 2,245,623 / 2,387,222

Unassembled Double Face Kits w/out Reveal - For Flexible Faces

Flat 2 PC D/F Body w/ Flat Bleed Retro Frame II and Cover

Part #2009
K2009/2107/21

Part #2107

Part #2121

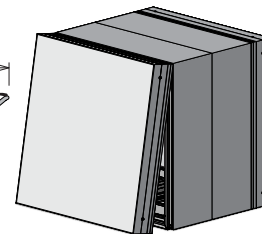
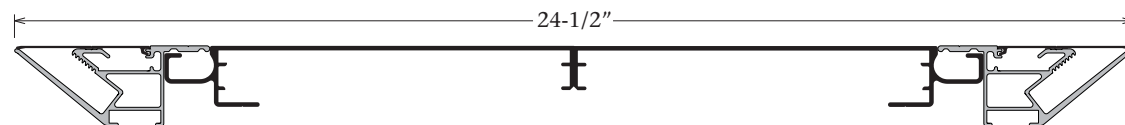

Size H'xW'	Mill Finish	Size H'xW'	Mill Finish	Size H'xW'	Mill Finish	Size H'xW'	Mill Finish
2 x 3	\$982	4 x 4	\$1316	6 x 6	\$1812	8 x 14	\$3026
2 x 4	1097	4 x 5	1430	6 x 7	1948	8 x 15	3140
2 x 5	1208	4 x 6	1565	6 x 8	2060	8 x 16	3249
2 x 6	1342	4 x 7	1702	6 x 9	2170	8 x 17	3389
2 x 7	1478	4 x 8	1812	6 x 10	2306	8 x 18	3498
2 x 8	1590	4 x 9	1925	6 x 11	2419	8 x 19	3636
2 x 9	1702	4 x 10	2060	6 x 12	2531	8 x 20	3745
2 x 10	1835	4 x 11	2170	6 x 13	2666		
2 x 11	1948	4 x 12	2282	6 x 14	2778	9 x 9	2531
2 x 12	2060	4 x 13	2419	6 x 15	2891	9 x 10	2666
2 x 13	2195	4 x 14	2531	6 x 16	3026	9 x 11	2778
2 x 14	2307	4 x 15	2643	6 x 17	3140	9 x 12	2891
2 x 15	2420	4 x 16	2778	6 x 18	3249	9 x 13	3026
2 x 16	2554	4 x 17	2891	6 x 19	3389	9 x 14	3140
2 x 17	2666	4 x 18	3002	6 x 20	3498	9 x 15	3249
2 x 18	2778	4 x 19	3140			9 x 16	3389
2 x 19	2915	4 x 20	3249	7 x 7	2084	9 x 17	3498
2 x 20	3026			7 x 8	2195	9 x 18	3612
		5 x 5	1542	7 x 9	2306	9 x 19	3745
3 x 3	1097	5 x 6	1677	7 x 10	2442	9 x 20	3858
3 x 4	1208	5 x 7	1812	7 x 11	2554		
3 x 5	1318	5 x 8	1925	7 x 12	2666	10 x 10	2801
3 x 6	1453	5 x 9	2036	7 x 13	2801	10 x 11	2915
3 x 7	1590	5 x 10	2170	7 x 14	2915	10 x 12	3026
3 x 8	1702	5 x 11	2282	7 x 15	3026	10 x 13	3165
3 x 9	1812	5 x 12	2394	7 x 16	3165	10 x 14	3273
3 x 10	1948	5 x 13	2531	7 x 17	3273	10 x 15	3389
3 x 11	2060	5 x 14	2643	7 x 18	3389	10 x 16	3521
3 x 12	2170	5 x 15	2754	7 x 19	3521	10 x 17	3636
3 x 13	2307	5 x 16	2891	7 x 20	3636	10 x 18	3745
3 x 14	2420	5 x 17	3002			10 x 19	3883
3 x 15	2531	5 x 18	3117	8 x 8	2306	10 x 20	3987
3 x 16	2666	5 x 19	3249	8 x 9	2419		
3 x 17	2778	5 x 20	3364	8 x 10	2531		
3 x 18	2891			8 x 11	2666		
3 x 19	3026			8 x 12	2778		
3 x 20	3140			8 x 13	2891		

Kits Include:

- Mill Finish
- Cut to size and mitered bodies
- Cut to size and mitered frames with covers
- Tension Clips
- Frame Braces for LED applications (Part #5357)
- All screws required to assemble by mechanical fastening
- All Corner Angles and/or Corner Keys required
- Packaging

Not Included in Kits:

- Faces
- Electrical Components
- Internal Supports
- Frame Support Tube - See optional accessories
- Tension Tool - See optional accessories

Optional Accessories (pg 127):

- Frame Support Tube
- Tension Tool

Kit Specifications:

- It is recommended to order kits 1" over nominal T12 or T8 lamp size to utilize .040 flat Aluminum Raceway Covers

- Custom size kits may be cut to any dimension
- Flexible face preparation - See page 129
- Frame Brace / Frame Support Tube placement - See page 130

Recommended Lamp Spacing:

- For illuminated backgrounds - 12" on center, using T12 or T8 lamps

Additional Information (pgs 196-197)

Note: All dimensions are subject to the tolerance standards of the aluminum extrusion industry. Profile drawings are illustrative and rounded to the nearest 1/16".

CURRENT PRICE as of April 1, 2022



COMMERCIAL

Unassembled Retro Kits w/out Reveal - For Flexible Faces

Flat Retro Body w/ Flat Bleed Retro Frame and Cover

Part #2041
K2041/2104/21

Part #2104

Part #2121

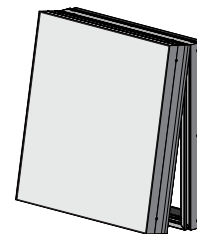
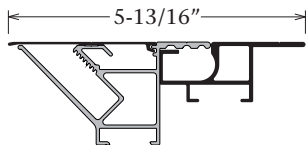

Size H'xW'	Mill Finish	Size H'xW'	Mill Finish	Size H'xW'	Mill Finish	Size H'xW'	Mill Finish
2 x 3	\$304	4 x 4	\$409	6 x 6	\$571	8 x 14	\$974
2 x 4	338	4 x 5	443	6 x 7	622	8 x 15	1009
2 x 5	372	4 x 6	490	6 x 8	657	8 x 16	1043
2 x 6	421	4 x 7	538	6 x 9	690	8 x 17	1090
2 x 7	467	4 x 8	571	6 x 10	738	8 x 18	1125
2 x 8	502	4 x 9	609	6 x 11	773	8 x 19	1174
2 x 9	538	4 x 10	657	6 x 12	808	8 x 20	1209
2 x 10	585	4 x 11	690	6 x 13	856		
2 x 11	622	4 x 12	728	6 x 14	890	9 x 9	808
2 x 12	657	4 x 13	773	6 x 15	924	9 x 10	856
2 x 13	702	4 x 14	808	6 x 16	974	9 x 11	890
2 x 14	738	4 x 15	844	6 x 17	1009	9 x 12	924
2 x 15	774	4 x 16	890	6 x 18	1043	9 x 13	974
2 x 16	820	4 x 17	924	6 x 19	1090	9 x 14	1009
2 x 17	856	4 x 18	962	6 x 20	1125	9 x 15	1043
2 x 18	890	4 x 19	1009			9 x 16	1090
2 x 19	936	4 x 20	1043	7 x 7	669	9 x 17	1125
2 x 20	974			7 x 8	702	9 x 18	1161
		5 x 5	478	7 x 9	738	9 x 19	1209
3 x 3	338	5 x 6	526	7 x 10	784	9 x 20	1244
3 x 4	372	5 x 7	571	7 x 11	820		
3 x 5	409	5 x 8	609	7 x 12	856	10 x 10	902
3 x 6	455	5 x 9	643	7 x 13	902	10 x 11	936
3 x 7	502	5 x 10	690	7 x 14	936	10 x 12	974
3 x 8	538	5 x 11	728	7 x 15	974	10 x 13	1021
3 x 9	571	5 x 12	761	7 x 16	1021	10 x 14	1055
3 x 10	622	5 x 13	808	7 x 17	1055	10 x 15	1090
3 x 11	657	5 x 14	844	7 x 18	1090	10 x 16	1137
3 x 12	690	5 x 15	878	7 x 19	1137	10 x 17	1174
3 x 13	738	5 x 16	924	7 x 20	1174	10 x 18	1209
3 x 14	773	5 x 17	962			10 x 19	1256
3 x 15	808	5 x 18	997	8 x 8	738	10 x 20	1288
3 x 16	856	5 x 19	1043	8 x 9	773		
3 x 17	890	5 x 20	1079	8 x 10	808		
3 x 18	924			8 x 11	856		
3 x 19	974			8 x 12	890		
3 x 20	1009			8 x 13	924		

Kits Include:

- Mill Finish
- Cut to size and mitered bodies
- Cut to size and mitered frames with covers
- Tension Clips
- Frame Braces for LED applications (Part #5357)
- All screws required to assemble by mechanical fastening
- All Corner Angles and/or Corner Keys required
- Packaging
- Prices reflect one (1) Flat Retro Body kit, SINGLE FACE APPLICATION

Not Included in Kits:

- Face
- Electrical Components
- Frame Support Tube - See optional accessories
- Tension Tool - See optional accessories
- Mounting Provisions
- Channel Letter Raceway U-Channel - See optional accessories
- Compression Gasket - See optional accessories

Optional Accessories (pg 127):

- Frame Support Tube
- Tension Tool
- Channel Letter Raceway U-Channel
- Compression Gasket

Kit Specifications:

- Kits will be cut .265" larger to fit over the existing structure
- Custom size kits may be cut to any dimension
- Illumination may vary depending on application
- Flexible face preparation - See page 129
- Frame Brace / Frame Support Tube placement - See page 130

Additional Information (pgs 196-197)



Note: It is recommended to use safety chains and prop-bars on all hingeable faces.

US Patent Numbers 6,061,941 / 6,637,080
CA Patent Numbers 2,245,623 / 2,387,222

Unassembled Single Face Kits w/out Reveal - For Flexible Faces

Flat Wall Mount Retro Body w/ Flat Bleed Retro Frame and Cover

Part #2042
K2042/2104/21

Part #2104

Part #2121

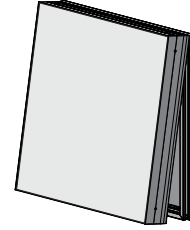
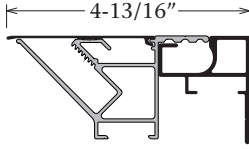

Size H'xW'	Mill Finish	Size H'xW'	Mill Finish	Size H'xW'	Mill Finish	Size H'xW'	Mill Finish
2 x 3	\$292	4 x 4	\$392	6 x 6	\$526	8 x 14	\$865
2 x 4	325	4 x 5	425	6 x 7	562	8 x 15	900
2 x 5	360	4 x 6	460	6 x 8	595	8 x 16	932
2 x 6	392	4 x 7	494	6 x 9	627	8 x 17	966
2 x 7	425	4 x 8	526	6 x 10	662	8 x 18	999
2 x 8	460	4 x 9	562	6 x 11	697	8 x 19	1034
2 x 9	494	4 x 10	595	6 x 12	729	8 x 20	1067
2 x 10	526	4 x 11	627	6 x 13	765		
2 x 11	562	4 x 12	662	6 x 14	797	9 x 9	729
2 x 12	595	4 x 13	697	6 x 15	831	9 x 10	765
2 x 13	627	4 x 14	729	6 x 16	865	9 x 11	797
2 x 14	662	4 x 15	765	6 x 17	900	9 x 12	831
2 x 15	697	4 x 16	797	6 x 18	932	9 x 13	865
2 x 16	730	4 x 17	831	6 x 19	966	9 x 14	900
2 x 17	765	4 x 18	865	6 x 20	999	9 x 15	932
2 x 18	797	4 x 19	900			9 x 16	966
2 x 19	831	4 x 20	932	7 x 7	595	9 x 17	999
2 x 20	865			7 x 8	627	9 x 18	1034
		5 x 5	460	7 x 9	662	9 x 19	1067
3 x 3	325	5 x 6	494	7 x 10	697	9 x 20	1102
3 x 4	360	5 x 7	526	7 x 11	729		
3 x 5	392	5 x 8	562	7 x 12	765	10 x 10	797
3 x 6	425	5 x 9	595	7 x 13	797	10 x 11	831
3 x 7	460	5 x 10	627	7 x 14	831	10 x 12	865
3 x 8	494	5 x 11	662	7 x 15	865	10 x 13	900
3 x 9	526	5 x 12	697	7 x 16	900	10 x 14	932
3 x 10	562	5 x 13	729	7 x 17	932	10 x 15	966
3 x 11	595	5 x 14	765	7 x 18	966	10 x 16	999
3 x 12	627	5 x 15	797	7 x 19	999	10 x 17	1034
3 x 13	662	5 x 16	831	7 x 20	1034	10 x 18	1067
3 x 14	697	5 x 17	865			10 x 19	1102
3 x 15	730	5 x 18	900	8 x 8	662	10 x 20	1133
3 x 16	765	5 x 19	932	8 x 9	697		
3 x 17	797	5 x 20	966	8 x 10	729		
3 x 18	831			8 x 11	765		
3 x 19	865			8 x 12	797		
3 x 20	900			8 x 13	831		

Kits Include:

- Mill Finish
- Cut to size and mitered bodies
- Cut to size and mitered frames with covers
- Tension Clips
- Frame Braces for LED applications (Part #5352)
- All screws required to assemble by mechanical fastening
- All Corner Angles and/or Corner Keys required
- Packaging

Not Included in Kits:

- Face or Back
- Electrical Component
- Back Braces and Gussets
- Frame Support Tube - See optional accessories
- Tension Tool - See optional accessories
- Mounting Provisions
- Channel Letter Raceway U-Channel - See optional accessories
- Compression Gasket - See optional accessories

Optional Accessories (pg 127):

- Frame Support Tube
- Tension Tool
- Channel Letter Raceway U-Channel
- Compression Gasket

Kit Specifications:

- **Recommended for LED applications**
- Custom size kits may be cut to any dimension
- Flexible face preparation - See page 129
- Frame Brace / Frame Support Tube placement - See page 130

Additional Information (pgs 196-197)



US Patent Numbers 9,208,701 / 6,061,941 / 6,637,080
CA Patent Numbers 2,245,623 / 2,387,222

Note: All dimensions are subject to the tolerance standards of the aluminum extrusion industry. Profile drawings are illustrative and rounded to the nearest 1/16".

CURRENT PRICE as of April 1, 2022



COMMERCIAL

Unassembled Single Face Kits w/out Reveal - For Flexible Faces

Flat S/F Body w/ Flat Bleed Retro Frame and Cover

Part #2027
K2027/2104/21

Part #2104

Part #2121

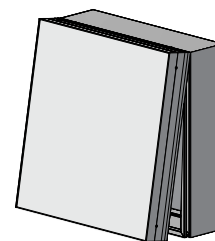
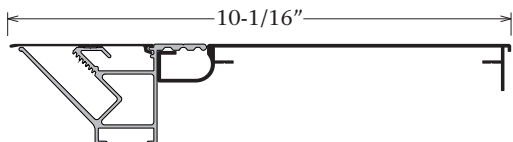

Size H'xW'	Mill Finish	Size H'xW'	Mill Finish	Size H'xW'	Mill Finish	Size H'xW'	Mill Finish
2 x 3	\$384	4 x 4	\$507	6 x 6	\$698	8 x 14	\$1167
2 x 4	424	4 x 5	548	6 x 7	753	8 x 15	1209
2 x 5	464	4 x 6	602	6 x 8	795	8 x 16	1252
2 x 6	519	4 x 7	655	6 x 9	837	8 x 17	1306
2 x 7	571	4 x 8	698	6 x 10	891	8 x 18	1347
2 x 8	614	4 x 9	740	6 x 11	932	8 x 19	1403
2 x 9	655	4 x 10	795	6 x 12	975	8 x 20	1446
2 x 10	710	4 x 11	837	6 x 13	1029	9 x 9	975
2 x 11	753	4 x 12	880	6 x 14	1071	9 x 10	1029
2 x 12	795	4 x 13	932	6 x 15	1114	9 x 11	1071
2 x 13	849	4 x 14	975	6 x 16	1167	9 x 12	1114
2 x 14	891	4 x 15	1018	6 x 17	1209	9 x 13	1167
2 x 15	932	4 x 16	1071	6 x 18	1252	9 x 14	1209
2 x 16	987	4 x 17	1114	6 x 19	1306	9 x 15	1252
2 x 17	1029	4 x 18	1156	6 x 20	1347	9 x 16	1306
2 x 18	1071	4 x 19	1209	7 x 7	807	9 x 17	1347
2 x 19	1126	4 x 20	1252	7 x 8	849	9 x 18	1390
2 x 20	1167			7 x 9	891	9 x 19	1446
		5 x 5	591	7 x 10	944	9 x 20	1488
3 x 3	424	5 x 6	643	7 x 11	987		
3 x 4	464	5 x 7	698	7 x 12	1029	10 x 10	1082
3 x 5	507	5 x 8	740	7 x 13	1083	10 x 11	1126
3 x 6	560	5 x 9	781	7 x 14	1126	10 x 12	1167
3 x 7	614	5 x 10	837	7 x 15	1167	10 x 13	1221
3 x 8	655	5 x 11	880	7 x 16	1221	10 x 14	1264
3 x 9	698	5 x 12	920	7 x 17	1264	10 x 15	1306
3 x 10	753	5 x 13	975	7 x 18	1306	10 x 16	1360
3 x 11	795	5 x 14	1018	7 x 19	1360	10 x 17	1403
3 x 12	837	5 x 15	1060	7 x 20	1403	10 x 18	1446
3 x 13	891	5 x 16	1114			10 x 19	1500
3 x 14	932	5 x 17	1156	8 x 8	891	10 x 20	1538
3 x 15	975	5 x 18	1197	8 x 9	932		
3 x 16	1029	5 x 19	1252	8 x 10	975		
3 x 17	1071	5 x 20	1295	8 x 11	1029		
3 x 18	1114			8 x 12	1071		
3 x 19	1167			8 x 13	1114		
3 x 20	1209						

Kits Include:

- Mill Finish
- Cut to size and mitered bodies
- Cut to size and mitered frames with covers
- Tension Clips
- Frame Braces for LED applications (Part #5357)
- All screws required to assemble by mechanical fastening
- All Corner Angles and/or Corner Keys required
- Packaging

Not Included in Kits:

- Face or Back
- Electrical Component
- Back Braces and Gussets
- Frame Support Tube - See optional accessories
- Tension Tool - See optional accessories
- Mounting Provisions

Optional Accessories (pg 127):

- Frame Support Tube
- Tension Tool

Kit Specifications:

- It is recommended to order kits 1" over nominal T-12 or T8 lamp size to utilize .040 flat Aluminum Raceway Covers

- Custom size kits may be cut to any dimension
- Flexible face preparation - See page 129
- Frame Brace / Frame Support Tube placement - See page 130

Recommended Lamp Spacing:

- For illuminated backgrounds - 12" on center, using T12 or T8 lamps
- Always place lamps 3/4" from back of sign
- When using lamps, deduct \$5.11 per Frame Brace

Additional Information (pgs 196-197)

UL Recognized Component Systems
The Underwriters Laboratory file number is E136850

Note: It is recommended to use safety chains and prop-bars on all hingeable faces.

US Patent Numbers 6,061,941 / 6,637,080
CA Patent Numbers 2,245,623 / 2,387,222

Unassembled Double Face Kits w/out Reveal - For Flexible Faces

Flat D/F Medium Body w/ Flat Bleed Retro Frame and Cover

Part #2007
K2007/2104/21

Part #2104

Part #2121

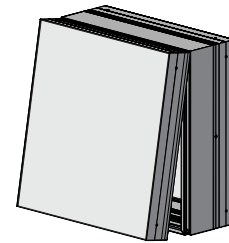
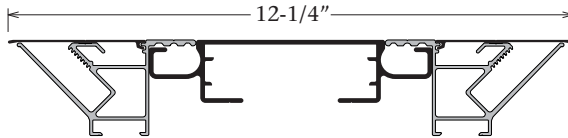

Size H'xW'	Mill Finish	Size H'xW'	Mill Finish	Size H'xW'	Mill Finish	Size H'xW'	Mill Finish
2 x 3	\$603	4 x 4	\$812	6 x 6	\$1094	8 x 14	\$1795
2 x 4	673	4 x 5	883	6 x 7	1164	8 x 15	1867
2 x 5	744	4 x 6	954	6 x 8	1235	8 x 16	1937
2 x 6	812	4 x 7	1025	6 x 9	1303	8 x 17	2009
2 x 7	883	4 x 8	1094	6 x 10	1374	8 x 18	2076
2 x 8	954	4 x 9	1164	6 x 11	1446	8 x 19	2147
2 x 9	1025	4 x 10	1235	6 x 12	1516	8 x 20	2218
2 x 10	1094	4 x 11	1303	6 x 13	1586		
2 x 11	1164	4 x 12	1374	6 x 14	1655	9 x 9	1516
2 x 12	1236	4 x 13	1446	6 x 15	1727	9 x 10	1586
2 x 13	1303	4 x 14	1516	6 x 16	1798	9 x 11	1655
2 x 14	1375	4 x 15	1586	6 x 17	1867	9 x 12	1727
2 x 15	1446	4 x 16	1656	6 x 18	1937	9 x 13	1795
2 x 16	1516	4 x 17	1727	6 x 19	2009	9 x 14	1867
2 x 17	1586	4 x 18	1798	6 x 20	2076	9 x 15	1937
2 x 18	1656	4 x 19	1867			9 x 16	2009
2 x 19	1727	4 x 20	1937	7 x 7	1235	9 x 17	2076
2 x 20	1798			7 x 8	1303	9 x 18	2147
		5 x 5	954	7 x 9	1374	9 x 19	2218
3 x 3	673	5 x 6	1025	7 x 10	1446	9 x 20	2289
3 x 4	744	5 x 7	1094	7 x 11	1516		
3 x 5	812	5 x 8	1164	7 x 12	1586	10 x 10	1655
3 x 6	883	5 x 9	1235	7 x 13	1655	10 x 11	1727
3 x 7	954	5 x 10	1303	7 x 14	1727	10 x 12	1795
3 x 8	1025	5 x 11	1374	7 x 15	1798	10 x 13	1867
3 x 9	1094	5 x 12	1446	7 x 16	1867	10 x 14	1937
3 x 10	1164	5 x 13	1516	7 x 17	1937	10 x 15	2009
3 x 11	1236	5 x 14	1586	7 x 18	2009	10 x 16	2076
3 x 12	1303	5 x 15	1656	7 x 19	2076	10 x 17	2147
3 x 13	1375	5 x 16	1727	7 x 20	2147	10 x 18	2218
3 x 14	1446	5 x 17	1798			10 x 19	2289
3 x 15	1516	5 x 18	1867	8 x 8	1374	10 x 20	2354
3 x 16	1586	5 x 19	1937	8 x 9	1446		
3 x 17	1656	5 x 20	2009	8 x 10	1516		
3 x 18	1727			8 x 11	1586		
3 x 19	1798			8 x 12	1655		
3 x 20	1867			8 x 13	1727		

Kits Include:

- Mill Finish
- Cut to size and mitered bodies
- Cut to size and mitered frames with covers
- Tension Clips
- Frame Braces for LED applications (Part #5350)
- All screws required to assemble by mechanical fastening
- All Corner Angles and/or Corner Keys required
- Packaging

Not Included in Kits:

- Faces
- Electrical Components
- Internal Supports
- Frame Support Tube - See optional accessories
- Tension Tool - See optional accessories

Optional Accessories (pg 127):

- Frame Support Tube
- Tension Tool

Kit Specifications:

- It is recommended to order kits 1" over nominal T12 or T8 lamp size to utilize .040 flat Aluminum Raceway Covers
- Custom size kits may be cut to any dimension
- Flexible face preparation - See page 129
- Frame Brace / Frame Support Tube placement - See page 130

Recommended Lamp Spacing:

- For illuminated backgrounds - 12" on center, using T12 or T8 lamps

Additional Information (pgs 196-197)

Note: All dimensions are subject to the tolerance standards of the aluminum extrusion industry. Profile drawings are illustrative and rounded to the nearest 1/16".

CURRENT PRICE as of April 1, 2022



COMMERCIAL

Unassembled Double Face Kits w/out Reveal - For Flexible Faces

Flat D/F Body w/ Flat Bleed Retro Frame and Cover

Part #2008
K2008/2104/21

Part #2104

Part #2121

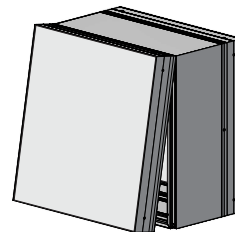
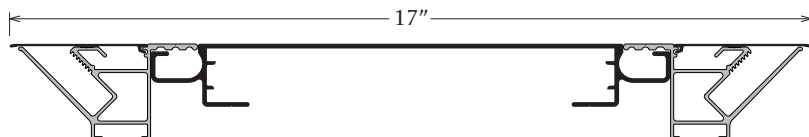

Size H'xW'	Mill Finish	Size H'xW'	Mill Finish	Size H'xW'	Mill Finish	Size H'xW'	Mill Finish
2 x 3	\$724	4 x 4	\$972	6 x 6	\$1351	8 x 14	\$2282
2 x 4	805	4 x 5	1054	6 x 7	1461	8 x 15	2365
2 x 5	888	4 x 6	1161	6 x 8	1542	8 x 16	2447
2 x 6	995	4 x 7	1269	6 x 9	1624	8 x 17	2556
2 x 7	1102	4 x 8	1351	6 x 10	1732	8 x 18	2638
2 x 8	1188	4 x 9	1437	6 x 11	1816	8 x 19	2746
2 x 9	1269	4 x 10	1542	6 x 12	1900	8 x 20	2829
2 x 10	1375	4 x 11	1624	6 x 13	2008		
2 x 11	1461	4 x 12	1708	6 x 14	2091	9 x 9	1900
2 x 12	1542	4 x 13	1816	6 x 15	2172	9 x 10	2007
2 x 13	1649	4 x 14	1900	6 x 16	2282	9 x 11	2091
2 x 14	1732	4 x 15	1985	6 x 17	2365	9 x 12	2172
2 x 15	1816	4 x 16	2091	6 x 18	2447	9 x 13	2282
2 x 16	1923	4 x 17	2174	6 x 19	2556	9 x 14	2365
2 x 17	2008	4 x 18	2259	6 x 20	2638	9 x 15	2447
2 x 18	2091	4 x 19	2365			9 x 16	2556
2 x 19	2198	4 x 20	2447	7 x 7	1568	9 x 17	2638
2 x 20	2282			7 x 8	1649	9 x 18	2722
		5 x 5	1137	7 x 9	1732	9 x 19	2829
3 x 3	805	5 x 6	1243	7 x 10	1839	9 x 20	2913
3 x 4	888	5 x 7	1351	7 x 11	1923		
3 x 5	972	5 x 8	1437	7 x 12	2008	10 x 10	2114
3 x 6	1077	5 x 9	1518	7 x 13	2114	10 x 11	2196
3 x 7	1186	5 x 10	1624	7 x 14	2196	10 x 12	2282
3 x 8	1269	5 x 11	1708	7 x 15	2282	10 x 13	2389
3 x 9	1351	5 x 12	1791	7 x 16	2389	10 x 14	2472
3 x 10	1461	5 x 13	1900	7 x 17	2472	10 x 15	2556
3 x 11	1542	5 x 14	1985	7 x 18	2556	10 x 16	2661
3 x 12	1624	5 x 15	2067	7 x 19	2661	10 x 17	2746
3 x 13	1732	5 x 16	2172	7 x 20	2746	10 x 18	2829
3 x 14	1816	5 x 17	2259			10 x 19	2937
3 x 15	1900	5 x 18	2341	8 x 8	1732	10 x 20	3014
3 x 16	2008	5 x 19	2447	8 x 9	1816		
3 x 17	2091	5 x 20	2532	8 x 10	1900		
3 x 18	2174			8 x 11	2007		
3 x 19	2282			8 x 12	2091		
3 x 20	2366			8 x 13	2172		

Kits Include:

- Mill Finish
- Cut to size and mitered bodies
- Cut to size and mitered frames with covers
- Tension Clips
- Frame Braces for LED applications (Part #5357)
- All screws required to assemble by mechanical fastening
- All Corner Angles and/or Corner Keys required
- Packaging

Not Included in Kits:

- Faces
- Electrical Component
- Internal Supports
- Frame Support Tube - See optional accessories
- Tension Tool - See optional accessories

Optional Accessories (pg 127):

- Frame Support Tube
- Tension Tool

Kit Specifications:

- It is recommended to order kits 1" over nominal T12 or T8 lamp size to utilize .040 flat Aluminum Raceway Covers

- Custom size kits may be cut to any dimension
- Flexible face preparation - See page 129
- Frame Brace / Frame Support Tube placement - See page 130

Recommended Lamp Spacing:

- For illuminated backgrounds - 12" on center, using T12 or T8 lamps
- When using lamps, deduct \$5.11 per Frame Brace

Additional Information (pgs 196-197)

UL Recognized Component Systems
The Underwriters Laboratory file number is E136850

Note: It is recommended to use safety chains and prop-bars on hingeable faces.

US Patent Numbers 6,061,941 / 6,637,080
CA Patent Numbers 2,245,623 / 2,387,222

Unassembled Double Face Kits w/out Reveal - For Flexible Faces

Flat 2 PC D/F Medium Body w/ Flat Bleed Retro Frame and Cover

Part #2010
K2010/2104/21

Part #2104

Part #2121

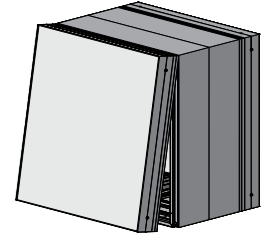
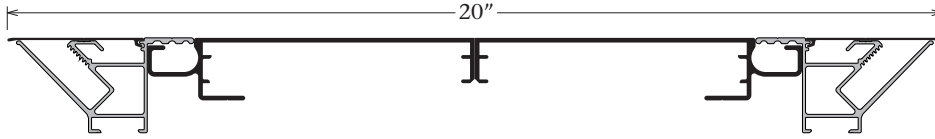

Size H'xW'	Mill Finish	Size H'xW'	Mill Finish	Size H'xW'	Mill Finish	Size H'xW'	Mill Finish
2 x 3	\$849	4 x 4	\$1133	6 x 6	\$1565	8 x 14	\$2623
2 x 4	943	4 x 5	1228	6 x 7	1684	8 x 15	2718
2 x 5	1038	4 x 6	1348	6 x 8	1779	8 x 16	2813
2 x 6	1157	4 x 7	1469	6 x 9	1875	8 x 17	2936
2 x 7	1277	4 x 8	1565	6 x 10	1996	8 x 18	3028
2 x 8	1374	4 x 9	1661	6 x 11	2093	8 x 19	3150
2 x 9	1469	4 x 10	1779	6 x 12	2188	8 x 20	3247
2 x 10	1589	4 x 11	1875	6 x 13	2310		
2 x 11	1684	4 x 12	1970	6 x 14	2404	9 x 9	2188
2 x 12	1779	4 x 13	2093	6 x 15	2501	9 x 10	2310
2 x 13	1900	4 x 14	2188	6 x 16	2623	9 x 11	2404
2 x 14	1997	4 x 15	2287	6 x 17	2718	9 x 12	2501
2 x 15	2093	4 x 16	2404	6 x 18	2813	9 x 13	2623
2 x 16	2212	4 x 17	2501	6 x 19	2936	9 x 14	2718
2 x 17	2310	4 x 18	2599	6 x 20	3028	9 x 15	2813
2 x 18	2404	4 x 19	2718			9 x 16	2936
2 x 19	2524	4 x 20	2813	7 x 7	1804	9 x 17	3028
2 x 20	2623			7 x 8	1900	9 x 18	3127
		5 x 5	1325	7 x 9	1996	9 x 19	3247
3 x 3	943	5 x 6	1443	7 x 10	2116	9 x 20	3344
3 x 4	1038	5 x 7	1565	7 x 11	2212		
3 x 5	1133	5 x 8	1661	7 x 12	2310	10 x 10	2428
3 x 6	1252	5 x 9	1756	7 x 13	2428	10 x 11	2524
3 x 7	1374	5 x 10	1875	7 x 14	2524	10 x 12	2623
3 x 8	1469	5 x 11	1970	7 x 15	2623	10 x 13	2742
3 x 9	1565	5 x 12	2068	7 x 16	2742	10 x 14	2838
3 x 10	1684	5 x 13	2188	7 x 17	2838	10 x 15	2936
3 x 11	1779	5 x 14	2287	7 x 18	2936	10 x 16	3052
3 x 12	1875	5 x 15	2381	7 x 19	3052	10 x 17	3150
3 x 13	1997	5 x 16	2501	7 x 20	3150	10 x 18	3247
3 x 14	2093	5 x 17	2599			10 x 19	3368
3 x 15	2188	5 x 18	2694	8 x 8	1996	10 x 20	3456
3 x 16	2310	5 x 19	2813	8 x 9	2093		
3 x 17	2404	5 x 20	2911	8 x 10	2188		
3 x 18	2501			8 x 11	2310		
3 x 19	2623			8 x 12	2404		
3 x 20	2718			8 x 13	2501		

Kits Include:

- Mill Finish
- Cut to size and mitered bodies
- Cut to size and mitered frames with covers
- Tension Clips
- Frame Braces for LED applications (Part #5357)
- All screws required to assemble by mechanical fastening
- All Corner Angles and/or Corner Keys required
- Packaging

Not Included in Kits:

- Faces
- Electrical Components
- Internal Supports
- Frame Support Tube - See optional accessories
- Tension Tool - See optional accessories

Optional Accessories (pg 127):

- Frame Support Tube
- Tension Tool

Kit Specifications:

- It is recommended to order kits 1" over nominal T12 or T8 lamp size to utilize .040 flat Aluminum Raceway Covers
- Custom size kits may be cut to any dimension
- Flexible face preparation - See page 129
- Frame Brace / Frame Support Tube placement - See page 130

Recommended Lamp Spacing:

- For illuminated backgrounds - 12" on center, using T12 or T8 lamps

Additional Information (pgs 196-197)

Note: All dimensions are subject to the tolerance standards of the aluminum extrusion industry. Profile drawings are illustrative and rounded to the nearest 1/16".

CURRENT PRICE as of April 1, 2022



COMMERCIAL

Unassembled Double Face Kits w/out Reveal - For Flexible Faces

Flat 2 PC D/F Body w/ Flat Bleed Retro Frame and Cover

Part #2009
K2009/2104/21

Part #2104

Part #2121

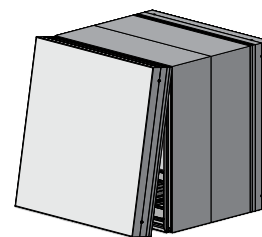
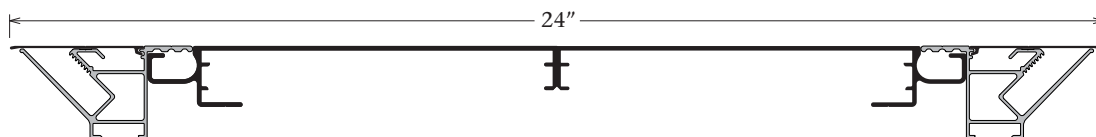

Size H'xW'	Mill Finish	Size H'xW'	Mill Finish	Size H'xW'	Mill Finish	Size H'xW'	Mill Finish
2 x 3	\$950	4 x 4	\$1264	6 x 6	\$1737	8 x 14	\$2903
2 x 4	1054	4 x 5	1371	6 x 7	1867	8 x 15	3010
2 x 5	1160	4 x 6	1501	6 x 8	1976	8 x 16	3115
2 x 6	1287	4 x 7	1632	6 x 9	2080	8 x 17	3249
2 x 7	1419	4 x 8	1737	6 x 10	2212	8 x 18	3352
2 x 8	1526	4 x 9	1844	6 x 11	2321	8 x 19	3483
2 x 9	1632	4 x 10	1976	6 x 12	2426	8 x 20	3590
2 x 10	1760	4 x 11	2081	6 x 13	2556		
2 x 11	1867	4 x 12	2187	6 x 14	2663	9 x 9	2426
2 x 12	1976	4 x 13	2321	6 x 15	2770	9 x 10	2556
2 x 13	2107	4 x 14	2426	6 x 16	2903	9 x 11	2663
2 x 14	2214	4 x 15	2535	6 x 17	3010	9 x 12	2769
2 x 15	2321	4 x 16	2663	6 x 18	3115	9 x 13	2903
2 x 16	2449	4 x 17	2770	6 x 19	3249	9 x 14	3010
2 x 17	2558	4 x 18	2879	6 x 20	3352	9 x 15	3115
2 x 18	2663	4 x 19	3010			9 x 16	3249
2 x 19	2794	4 x 20	3115	7 x 7	2001	9 x 17	3352
2 x 20	2903			7 x 8	2105	9 x 18	3459
		5 x 5	1478	7 x 9	2212	9 x 19	3590
3 x 3	1054	5 x 6	1607	7 x 10	2342	9 x 20	3699
3 x 4	1160	5 x 7	1737	7 x 11	2449		
3 x 5	1264	5 x 8	1844	7 x 12	2556	10 x 10	2687
3 x 6	1394	5 x 9	1953	7 x 13	2687	10 x 11	2793
3 x 7	1526	5 x 10	2080	7 x 14	2794	10 x 12	2903
3 x 8	1632	5 x 11	2187	7 x 15	2903	10 x 13	3035
3 x 9	1737	5 x 12	2295	7 x 16	3035	10 x 14	3140
3 x 10	1867	5 x 13	2426	7 x 17	3140	10 x 15	3249
3 x 11	1976	5 x 14	2535	7 x 18	3249	10 x 16	3376
3 x 12	2081	5 x 15	2640	7 x 19	3376	10 x 17	3483
3 x 13	2212	5 x 16	2770	7 x 20	3484	10 x 18	3590
3 x 14	2321	5 x 17	2879			10 x 19	3724
3 x 15	2426	5 x 18	2986	8 x 8	2212	10 x 20	3822
3 x 16	2558	5 x 19	3115	8 x 9	2319		
3 x 17	2663	5 x 20	3224	8 x 10	2426		
3 x 18	2770			8 x 11	2556		
3 x 19	2903			8 x 12	2663		
3 x 20	3010			8 x 13	2769		

Kits Include:

- Mill Finish
- Cut to size and mitered bodies
- Cut to size and mitered frames with covers
- Tension Clips
- Frame Braces for LED applications (Part #5357)
- All screws required to assemble by mechanical fastening
- All Corner Angles and/or Corner Keys required
- Packaging

Not Included in Kits:

- Faces
- Electrical Component
- Internal Supports
- Frame Support Tube - See optional accessories
- Tension Tool - See optional accessories

Optional Accessories (pg 127):

- Frame Support Tube
- Tension Tool

Kit Specifications:

- It is recommended to order kits 1" over nominal T12 or T8 lamp size to utilize .040 flat Aluminum Raceway Covers

- Custom size kits may be cut to any dimension
- Flexible face preparation - See page 129
- Frame Brace / Frame Support Tube placement - See page 130

Recommended Lamp Spacing:

- For illuminated backgrounds - 12" on center, using T12 or T8 lamps

Additional Information (pgs 196-197)

UL Recognized Component Systems
The Underwriters Laboratory file number is E136850

Note: It is recommended to use safety chains and prop-bars on hingeable faces.

US Patent Numbers 6,061,941 / 6,637,080
CA Patent Numbers 2,245,623 / 2,387,222

Unassembled Tension Body Kits - For Flexible Faces

5" Flat Bleed D/F Tension Body and 5" Flat Bleed D/F Tension Frame Cover

Part #2230
K2230/35

Part #2235

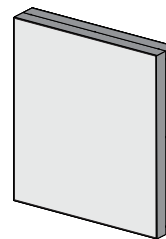
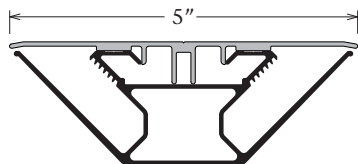

Size H'xW'	Mill Finish	Size H'xW'	Mill Finish	Size H'xW'	Mill Finish	Size H'xW'	Mill Finish
2 x 3	\$217	4 x 4	\$341	6 x 6	\$511	8 x 14	\$932
2 x 4	258	4 x 5	384	6 x 7	552	8 x 15	974
2 x 5	301	4 x 6	428	6 x 8	597	8 x 16	1015
2 x 6	341	4 x 7	468	6 x 9	638	8 x 17	1057
2 x 7	384	4 x 8	511	6 x 10	678	8 x 18	1100
2 x 8	428	4 x 9	552	6 x 11	721	8 x 19	1142
2 x 9	468	4 x 10	594	6 x 12	762	8 x 20	1183
2 x 10	510	4 x 11	638	6 x 13	807		
2 x 11	552	4 x 12	678	6 x 14	847	9 x 9	762
2 x 12	594	4 x 13	721	6 x 15	888	9 x 10	804
2 x 13	638	4 x 14	762	6 x 16	932	9 x 11	847
2 x 14	678	4 x 15	804	6 x 17	974	9 x 12	888
2 x 15	720	4 x 16	847	6 x 18	1015	9 x 13	932
2 x 16	762	4 x 17	888	6 x 19	1057	9 x 14	974
2 x 17	804	4 x 18	932	6 x 20	1098	9 x 15	1014
2 x 18	847	4 x 19	974			9 x 16	1057
2 x 19	888	4 x 20	1014	7 x 7	594	9 x 17	1098
2 x 20	930			7 x 8	638	9 x 18	1142
		5 x 5	425	7 x 9	678	9 x 19	1183
3 x 3	259	5 x 6	468	7 x 10	720	9 x 20	1224
3 x 4	302	5 x 7	510	7 x 11	762		
3 x 5	341	5 x 8	552	7 x 12	804	10 x 10	845
3 x 6	385	5 x 9	594	7 x 13	847	10 x 11	888
3 x 7	428	5 x 10	637	7 x 14	888	10 x 12	930
3 x 8	471	5 x 11	678	7 x 15	930	10 x 13	974
3 x 9	511	5 x 12	720	7 x 16	974	10 x 14	1014
3 x 10	552	5 x 13	762	7 x 17	1014	10 x 15	1055
3 x 11	597	5 x 14	804	7 x 18	1057	10 x 16	1098
3 x 12	638	5 x 15	845	7 x 19	1098	10 x 17	1138
3 x 13	681	5 x 16	888	7 x 20	1138	10 x 18	1183
3 x 14	721	5 x 17	930			10 x 19	1224
3 x 15	762	5 x 18	974	8 x 8	681	10 x 20	1265
3 x 16	807	5 x 19	1014	8 x 9	721		
3 x 17	847	5 x 20	1055	8 x 10	762		
3 x 18	890			8 x 11	807		
3 x 19	932			8 x 12	847		
3 x 20	974			8 x 13	890		

Kits Include:

- Mill Finish
- Cut to size and mitered bodies with covers
- Tension Clips
- All screws required to assemble by mechanical fastening
- Packaging

Not Included in Kits:

- Faces
- Electrical Components
- Internal Supports
- Small Frame Support Tube - See optional accessories
- Tension Tool - See optional accessories
- Mounting Provisions

Optional Accessories (pg 127):

- Small Frame Support Tube
- Tension Tool

Kit Specifications:

- **Recommended for LED applications**
- Custom size kits may be cut to any dimension
- Flexible face preparation - See page 129

Additional Information (pgs 196-197)

Note: All dimensions are subject to the tolerance standards of the aluminum extrusion industry. Profile drawings are illustrative and rounded to the nearest 1/16".

CURRENT PRICE as of April 1, 2022



COMMERCIAL

Unassembled Tension Body Kits - For Flexible Faces

6" Flat Bleed S/F Tension Body and 6" Flat Bleed S/F Tension Frame Cover

Part #2233
K2233/38

Part #2238

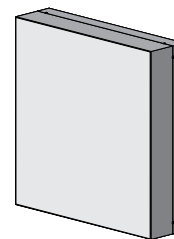
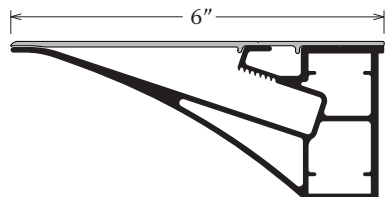

Size H'xW'	Mill Finish	Size H'xW'	Mill Finish	Size H'xW'	Mill Finish	Size H'xW'	Mill Finish
2 x 3	\$377	4 x 4	\$548	6 x 6	\$778	8 x 14	\$1354
2 x 4	434	4 x 5	606	6 x 7	836	8 x 15	1410
2 x 5	491	4 x 6	664	6 x 8	895	8 x 16	1469
2 x 6	548	4 x 7	721	6 x 9	951	8 x 17	1528
2 x 7	606	4 x 8	778	6 x 10	1009	8 x 18	1584
2 x 8	664	4 x 9	836	6 x 11	1066	8 x 19	1640
2 x 9	721	4 x 10	895	6 x 12	1122	8 x 20	1700
2 x 10	778	4 x 11	951	6 x 13	1181	9 x 9	1122
2 x 11	836	4 x 12	1009	6 x 14	1239	9 x 10	1181
2 x 12	895	4 x 13	1066	6 x 15	1296	9 x 11	1239
2 x 13	951	4 x 14	1122	6 x 16	1354	9 x 12	1296
2 x 14	1009	4 x 15	1181	6 x 17	1410	9 x 13	1354
2 x 15	1066	4 x 16	1239	6 x 18	1469	9 x 14	1410
2 x 16	1122	4 x 17	1296	6 x 19	1526	9 x 15	1469
2 x 17	1181	4 x 18	1354	6 x 20	1584	9 x 16	1526
2 x 18	1239	4 x 19	1410	7 x 7	895	9 x 17	1584
2 x 19	1296	4 x 20	1469	7 x 8	951	9 x 18	1640
2 x 20	1354			7 x 9	1009	9 x 19	1699
		5 x 5	664	7 x 10	1066	9 x 20	1756
3 x 3	434	5 x 6	721	7 x 11	1122		
3 x 4	491	5 x 7	778	7 x 12	1181	10 x 10	1239
3 x 5	548	5 x 8	836	7 x 13	1239	10 x 11	1296
3 x 6	606	5 x 9	895	7 x 14	1296	10 x 12	1354
3 x 7	664	5 x 10	951	7 x 15	1354	10 x 13	1410
3 x 8	721	5 x 11	1009	7 x 16	1410	10 x 14	1469
3 x 9	778	5 x 12	1066	7 x 17	1469	10 x 15	1526
3 x 10	836	5 x 13	1122	7 x 18	1526	10 x 16	1584
3 x 11	895	5 x 14	1181	7 x 19	1584	10 x 17	1640
3 x 12	951	5 x 15	1239	7 x 20	1640	10 x 18	1699
3 x 13	1009	5 x 16	1296	8 x 8	1009	10 x 19	1756
3 x 14	1066	5 x 17	1354	8 x 9	1066	10 x 20	1815
3 x 15	1122	5 x 18	1410	8 x 10	1122		
3 x 16	1181	5 x 19	1469	8 x 11	1181		
3 x 17	1239	5 x 20	1528	8 x 12	1239		
3 x 18	1296			8 x 13	1296		
3 x 19	1354						
3 x 20	1410						

Kits Include:

- Mill Finish
- Cut to size and mitered bodies with covers
- Tension Clips
- All screws required to assemble by mechanical fastening
- All Corner Angles required
- Packaging

Not Included in Kits:

- Face or Back
- Electrical Components
- Back Braces
- Small Frame Support Tube - See optional accessories
- Tension Tool - See optional accessories
- Mounting Provisions

Optional Accessories (pg 127):

- Small Frame Support Tube
- Tension Tool

Kit Specifications:

- Recommended for LED applications
- Custom size kits may be cut to any dimension
- Flexible face preparation - See page 129

Additional Information (pgs 196-197)

UL Recognized Component Systems
The Underwriters Laboratory file number is E136850

US Patent Numbers 6,061,941 / 6,637,080
CA Patent Numbers 2,245,623 / 2,387,222

Unassembled Retro Frame Kits w/ Reveal - For Flexible Faces

2" Retro Frame and 2-3/8" Retro Frame Cover

Part #2112
K2112/15

Part #2115

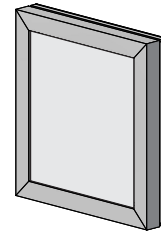
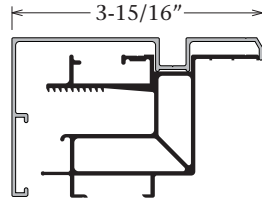

Size H'xW'	Mill Finish	Dk. Bronze	Size H'xW'	Mill Finish	Dk. Bronze	Size H'xW'	Mill Finish	Dk. Bronze	Size H'xW'	Mill Finish	Dk. Bronze
2 x 3	\$207	\$233	4 x 4	\$322	\$364	6 x 6	\$478	\$539	8 x 14	\$862	\$972
2 x 4	248	278	4 x 5	362	406	6 x 7	516	579	8 x 15	902	1011
2 x 5	286	321	4 x 6	399	450	6 x 8	552	622	8 x 16	939	1057
2 x 6	322	364	4 x 7	439	492	6 x 9	594	667	8 x 17	978	1098
2 x 7	362	406	4 x 8	478	539	6 x 10	630	709	8 x 18	1015	1142
2 x 8	399	450	4 x 9	516	579	6 x 11	670	752	8 x 19	1055	1186
2 x 9	439	492	4 x 10	552	622	6 x 12	709	797	8 x 20	1094	1228
2 x 10	478	539	4 x 11	594	667	6 x 13	748	839			
2 x 11	516	579	4 x 12	630	709	6 x 14	784	883	9 x 9	709	797
2 x 12	552	622	4 x 13	670	752	6 x 15	824	924	9 x 10	748	839
2 x 13	594	667	4 x 14	709	797	6 x 16	862	972	9 x 11	784	883
2 x 14	630	709	4 x 15	748	839	6 x 17	902	1011	9 x 12	824	924
2 x 15	670	752	4 x 16	784	883	6 x 18	939	1057	9 x 13	862	972
2 x 16	709	797	4 x 17	824	924	6 x 19	978	1098	9 x 14	902	1011
2 x 17	748	839	4 x 18	862	972	6 x 20	1015	1142	9 x 15	939	1057
2 x 18	784	883	4 x 19	902	1011				9 x 16	978	1098
2 x 19	824	924	4 x 20	939	1057	7 x 7	552	622	9 x 17	1015	1142
2 x 20	862	972				7 x 8	594	667	9 x 18	1055	1186
			5 x 5	399	450	7 x 9	630	709	9 x 19	1094	1228
3 x 3	248	278	5 x 6	439	492	7 x 10	670	752	9 x 20	1133	1272
3 x 4	286	321	5 x 7	478	539	7 x 11	709	797			
3 x 5	322	364	5 x 8	516	579	7 x 12	748	839	10 x 10	784	883
3 x 6	362	406	5 x 9	552	622	7 x 13	784	883	10 x 11	824	924
3 x 7	399	450	5 x 10	594	667	7 x 14	824	924	10 x 12	862	972
3 x 8	439	492	5 x 11	630	709	7 x 15	862	972	10 x 13	902	1011
3 x 9	478	539	5 x 12	670	752	7 x 16	902	1011	10 x 14	939	1057
3 x 10	516	579	5 x 13	709	797	7 x 17	939	1057	10 x 15	978	1098
3 x 11	552	622	5 x 14	748	839	7 x 18	978	1098	10 x 16	1015	1142
3 x 12	594	667	5 x 15	784	883	7 x 19	1015	1142	10 x 17	1055	1186
3 x 13	630	709	5 x 16	824	924	7 x 20	1055	1186	10 x 18	1094	1228
3 x 14	670	752	5 x 17	862	972				10 x 19	1133	1272
3 x 15	709	797	5 x 18	902	1011	8 x 8	630	709	10 x 20	1172	1316
3 x 16	748	839	5 x 19	939	1057	8 x 9	670	752			
3 x 17	784	883	5 x 20	978	1098	8 x 10	709	797			
3 x 18	824	924				8 x 11	748	839			
3 x 19	862	972				8 x 12	784	883			
3 x 20	902	1011				8 x 13	824	924			

Kits Include:

- Mill Finish Frame
- Mill Finish or Dk. Bronze Cover
- Cut to size and mitered frames with covers
- Tension Clips
- All screws required to assemble by mechanical fastening
- All Corner Angles and/or Corner Keys required
- Packaging
- Prices reflect one (1) Retro Frame Kit, SINGLE FACE APPLICATION

Not Included in Kits:

- Face
- Electrical Components
- Frame Support Tube - See optional accessories
- Frame Braces - See optional accessories
- Divider(s) - See optional accessories
- Tension Tool - See optional accessories
- Mounting Provisions

Optional Accessories (pg 127):

- Frame Support Tube
- Frame Braces
- Divider(s)
- Tension Tool

Kit Specifications:

- **Retro Frame is cut .420" larger and the cover is cut .930" larger in both the height and width dimensions to allow for the Retro Frame attachment and give .250" tolerance for fit**
- Custom size kits may be cut to any dimension
- Flexible face preparation - See page 129
- Frame Brace / Frame Support Tube placement - See page 130

Divider Kits Include:

- Cut to size dividers
- Divider Corner Angles
- All screws required to assemble by mechanical fastening
- Tension Clips
- **Dual Divider and 2-1/2" Dual Divider Cover, Parts #2142 and #2146, Mill Finish \$15.33 and Dk. Bronze \$18.54 per/ft per/face**

Additional Information (pgs 196-197)

Note: All dimensions are subject to the tolerance standards of the aluminum extrusion industry. Profile drawings are illustrative and rounded to the nearest 1/16".

CURRENT PRICE as of April 1, 2022



COMMERCIAL

Unassembled Retro Frame Kits w/ Reveal - For Flexible Faces

Bleed Retro Frame and Bleed Retro Frame Cover

Part #2105
K2105/22

Part #2122

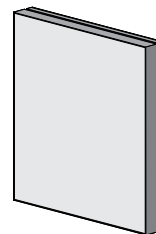
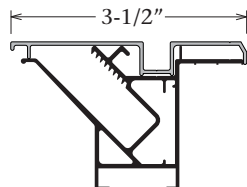

Size H'xW'	Mill Finish	Dk. Bronze	Size H'xW'	Mill Finish	Dk. Bronze	Size H'xW'	Mill Finish	Dk. Bronze	Size H'xW'	Mill Finish	Dk. Bronze
2 x 3	\$159	\$175	4 x 4	\$250	\$276	6 x 6	\$367	\$406	8 x 14	\$664	\$736
2 x 4	189	209	4 x 5	280	308	6 x 7	397	439	8 x 15	694	771
2 x 5	218	241	4 x 6	308	340	6 x 8	428	471	8 x 16	724	804
2 x 6	250	276	4 x 7	337	372	6 x 9	457	508	8 x 17	753	836
2 x 7	280	308	4 x 8	367	406	6 x 10	487	541	8 x 18	783	867
2 x 8	308	340	4 x 9	397	439	6 x 11	516	571	8 x 19	812	900
2 x 9	337	372	4 x 10	428	471	6 x 12	547	606	8 x 20	844	935
2 x 10	367	406	4 x 11	457	508	6 x 13	576	639	9 x 9	547	606
2 x 11	397	439	4 x 12	487	541	6 x 14	606	671	9 x 10	576	639
2 x 12	428	471	4 x 13	516	571	6 x 15	633	704	9 x 11	606	671
2 x 13	457	508	4 x 14	547	606	6 x 16	664	736	9 x 12	633	704
2 x 14	487	541	4 x 15	576	639	6 x 17	694	771	9 x 13	664	736
2 x 15	516	571	4 x 16	606	671	6 x 18	724	804	9 x 14	694	771
2 x 16	547	606	4 x 17	633	704	6 x 19	753	836	9 x 15	724	804
2 x 17	576	639	4 x 18	664	736	6 x 20	783	867	9 x 16	753	836
2 x 18	606	671	4 x 19	694	771	7 x 7	428	471	9 x 17	783	867
2 x 19	633	704	4 x 20	724	804	7 x 8	457	508	9 x 18	812	900
2 x 20	664	736				7 x 9	487	541	9 x 19	844	935
			5 x 5	308	340	7 x 10	516	571	9 x 20	874	969
3 x 3	189	209	5 x 6	337	372	7 x 11	547	606			
3 x 4	218	241	5 x 7	367	406	7 x 12	576	639	10 x 10	606	671
3 x 5	250	276	5 x 8	397	439	7 x 13	606	671	10 x 11	633	704
3 x 6	280	308	5 x 9	428	471	7 x 14	633	704	10 x 12	664	736
3 x 7	308	340	5 x 10	457	508	7 x 15	664	736	10 x 13	694	771
3 x 8	337	372	5 x 11	487	541	7 x 16	694	771	10 x 14	724	804
3 x 9	367	406	5 x 12	516	571	7 x 17	724	804	10 x 15	753	836
3 x 10	397	439	5 x 13	547	606	7 x 18	753	836	10 x 16	783	867
3 x 11	428	471	5 x 14	576	639	7 x 19	783	867	10 x 17	812	900
3 x 12	457	508	5 x 15	606	671	7 x 20	812	900	10 x 18	844	935
3 x 13	487	541	5 x 16	633	704	8 x 8	487	541	10 x 19	874	969
3 x 14	516	571	5 x 17	664	736	8 x 9	516	571	10 x 20	903	1002
3 x 15	547	606	5 x 18	694	771	8 x 10	547	606			
3 x 16	576	639	5 x 19	724	804	8 x 11	576	639			
3 x 17	606	671	5 x 20	753	836	8 x 12	606	671			
3 x 18	633	704				8 x 13	633	704			
3 x 19	664	736									
3 x 20	694	771									

Kits Include:

- Mill Finish Frame
- Mill Finish or Dk. Bronze Cover
- Cut to size and mitered frames with covers
- Tension Clips
- All screws required to assemble by mechanical fastening
- All Corner Angles and/or Corner Keys required
- Packaging
- Prices reflect one (1) Retro Frame Kit, SINGLE FACE APPLICATION

Not Included in Kits:

- Face
- Electrical Components
- Frame Support Tube - See optional accessories
- Frame Braces - See optional accessories
- Tension Tool - See optional accessories
- Retro Frame to structure fasteners
- Mounting Provisions

Optional Accessories (pg 127):

- Frame Support Tube
- Frame Braces
- Tension Tool

Kit Specifications:

- Retro Frame is cut .820" larger and the cover is cut .920" larger in both the height and width dimensions to allow for the Retro Frame attachment and give .250" tolerance for fit
- Custom size kits may be cut to any dimension
- Flexible face preparation - See page 129
- Frame Brace / Frame Support Tube placement - See page 130

Additional Information (pgs 196-197)



US Patent Numbers 6,061,941 / 6,637,080
CA Patent Numbers 2,245,623 / 2,387,222

Unassembled Retro Frame Kits w/out Reveal - For Flexible Faces

Flat Bleed Retro Frame and Cover Options

Part #2104

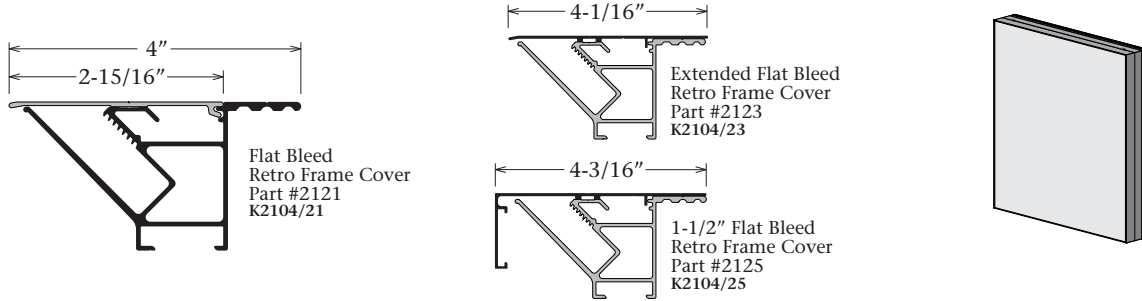

Size H'xW'	Mill Finish	Size H'xW'	Mill Finish	Size H'xW'	Mill Finish	Size H'xW'	Mill Finish
2 x 3	\$167	4 x 4	\$261	6 x 6	\$387	8 x 14	\$702
2 x 4	199	4 x 5	292	6 x 7	419	8 x 15	732
2 x 5	230	4 x 6	325	6 x 8	450	8 x 16	765
2 x 6	261	4 x 7	356	6 x 9	483	8 x 17	796
2 x 7	292	4 x 8	387	6 x 10	515	8 x 18	828
2 x 8	325	4 x 9	419	6 x 11	546	8 x 19	859
2 x 9	356	4 x 10	450	6 x 12	576	8 x 20	890
2 x 10	387	4 x 11	483	6 x 13	607		
2 x 11	419	4 x 12	515	6 x 14	639	9 x 9	576
2 x 12	450	4 x 13	546	6 x 15	671	9 x 10	607
2 x 13	483	4 x 14	576	6 x 16	702	9 x 11	639
2 x 14	515	4 x 15	607	6 x 17	732	9 x 12	671
2 x 15	546	4 x 16	639	6 x 18	765	9 x 13	702
2 x 16	576	4 x 17	671	6 x 19	796	9 x 14	732
2 x 17	607	4 x 18	702	6 x 20	828	9 x 15	765
2 x 18	639	4 x 19	732			9 x 16	796
2 x 19	671	4 x 20	765	7 x 7	450	9 x 17	828
2 x 20	702			7 x 8	483	9 x 18	859
		5 x 5	325	7 x 9	515	9 x 19	890
3 x 3	199	5 x 6	356	7 x 10	546	9 x 20	922
3 x 4	230	5 x 7	387	7 x 11	576		
3 x 5	261	5 x 8	419	7 x 12	607	10 x 10	639
3 x 6	292	5 x 9	450	7 x 13	639	10 x 11	671
3 x 7	325	5 x 10	483	7 x 14	671	10 x 12	702
3 x 8	356	5 x 11	515	7 x 15	702	10 x 13	732
3 x 9	387	5 x 12	546	7 x 16	732	10 x 14	765
3 x 10	419	5 x 13	576	7 x 17	765	10 x 15	796
3 x 11	450	5 x 14	607	7 x 18	796	10 x 16	828
3 x 12	483	5 x 15	639	7 x 19	828	10 x 17	859
3 x 13	515	5 x 16	671	7 x 20	859	10 x 18	890
3 x 14	546	5 x 17	702			10 x 19	922
3 x 15	576	5 x 18	732	8 x 8	515	10 x 20	953
3 x 16	607	5 x 19	765	8 x 9	546		
3 x 17	639	5 x 20	796	8 x 10	576		
3 x 18	671			8 x 11	607		
3 x 19	702			8 x 12	639		
3 x 20	732			8 x 13	671		

Kits Include:

- Mill Finish
- Cut to size and mitered frames with covers
- Tension Clips
- All screws required to assemble by mechanical fastening
- All Corner Angles required
- Packaging
- Prices reflect one (1) Retro Frame Kit, SINGLE FACE APPLICATION

Not Included in Kits:

- Face
- Electrical Components
- Frame Support Tube - See optional accessories
- Frame Braces - See optional accessories
- Tension Tool - See optional accessories
- Mounting Provisions

Optional Accessories (pg 127):

- Frame Support Tube
- Frame Braces
- Tension Tool

Kit Specifications:

- Retro Frames and covers are cut .500" larger in both the height and width dimensions to allow for the Retro Frame attachment and give .250" tolerance for fit
- Custom size kits may be cut to any dimension
- Flexible face preparation - See page 129
- Frame Brace / Frame Support Tube placement - See page 130

Additional Information (pgs 196-197)

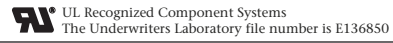

Note: All dimensions are subject to the tolerance standards of the aluminum extrusion industry. Profile drawings are illustrative and rounded to the nearest 1/16".

CURRENT PRICE as of April 1, 2022



COMMERCIAL

Unassembled Retro Frame Kits - For Flexible Faces

Wall Mount Frame w/ Flat Bleed Retro Frame and Cover

Part #2100
K2100/2104/21

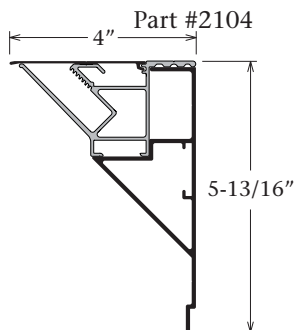

Part #2121

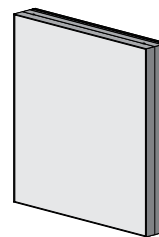

Size H'xW'	Mill Finish	Size H'xW'	Mill Finish	Size H'xW'	Mill Finish	Size H'xW'	Mill Finish
2 x 3	\$431	4 x 4	\$567	6 x 6	\$758	8 x 14	\$1227
2 x 4	474	4 x 5	615	6 x 7	805	8 x 15	1277
2 x 5	523	4 x 6	662	6 x 8	852	8 x 16	1325
2 x 6	571	4 x 7	716	6 x 9	900	8 x 17	1371
2 x 7	618	4 x 8	758	6 x 10	947	8 x 18	1421
2 x 8	662	4 x 9	811	6 x 11	998	8 x 19	1466
2 x 9	718	4 x 10	853	6 x 12	1042	8 x 20	1513
2 x 10	760	4 x 11	900	6 x 13	1089		
2 x 11	811	4 x 12	950	6 x 14	1136	9 x 9	1041
2 x 12	856	4 x 13	1003	6 x 15	1186	9 x 10	1086
2 x 13	904	4 x 14	1042	6 x 16	1233	9 x 11	1136
2 x 14	950	4 x 15	1094	6 x 17	1279	9 x 12	1181
2 x 15	1004	4 x 16	1141	6 x 18	1328	9 x 13	1233
2 x 16	1046	4 x 17	1186	6 x 19	1376	9 x 14	1275
2 x 17	1094	4 x 18	1237	6 x 20	1422	9 x 15	1328
2 x 18	1142	4 x 19	1285			9 x 16	1372
2 x 19	1189	4 x 20	1328	7 x 7	852	9 x 17	1422
2 x 20	1237			7 x 8	896	9 x 18	1469
		5 x 5	662	7 x 9	948	9 x 19	1516
3 x 3	480	5 x 6	710	7 x 10	991	9 x 20	1561
3 x 4	524	5 x 7	760	7 x 11	1041		
3 x 5	574	5 x 8	805	7 x 12	1088	10 x 10	1133
3 x 6	618	5 x 9	856	7 x 13	1137	10 x 11	1177
3 x 7	667	5 x 10	900	7 x 14	1181	10 x 12	1227
3 x 8	716	5 x 11	948	7 x 15	1235	10 x 13	1274
3 x 9	765	5 x 12	1002	7 x 16	1277	10 x 14	1319
3 x 10	811	5 x 13	1042	7 x 17	1328	10 x 15	1371
3 x 11	857	5 x 14	1089	7 x 18	1375	10 x 16	1416
3 x 12	904	5 x 15	1141	7 x 19	1423	10 x 17	1465
3 x 13	953	5 x 16	1186	7 x 20	1469	10 x 18	1509
3 x 14	1003	5 x 17	1235			10 x 19	1560
3 x 15	1051	5 x 18	1285	8 x 8	942	10 x 20	1607
3 x 16	1095	5 x 19	1330	8 x 9	991		
3 x 17	1142	5 x 20	1375	8 x 10	1038		
3 x 18	1192			8 x 11	1086		
3 x 19	1239			8 x 12	1134		
3 x 20	1290			8 x 13	1181		

Kits Include:

- Mill Finish
- Cut to size and mitered frames with covers
- Tension Clips
- All screws required to assemble by mechanical fastening
- All Corner Angles and/or Corner Keys required
- Packaging
- Prices reflect one (1) Retro Frame Kit, SINGLE FACE APPLICATION

Optional Accessories (pg 127):

- Tension Tool
- Kit Specifications:**
- Custom size kits may be cut to any dimension
- Flexible face preparation - See page 129

Additional Information (pgs 196-197)

Not Included in Kits:

- Face or Back
- Electrical Components
- Tension Tool - See optional accessories
- Mounting Provisions

UL Recognized Component Systems
The Underwriters Laboratory file number is E136850

US Patent Numbers 6,061,941 / 6,637,080
CA Patent Numbers 2,245,623 / 2,387,222

Unassembled Retro Frame Kits w/out Reveal - For Flexible Faces

Flat Bleed Retro Frame II and Cover Options

Part #2107

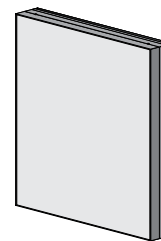
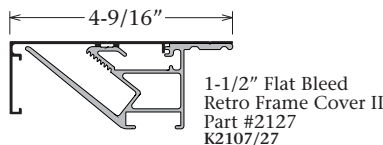
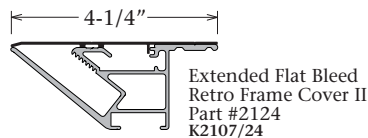
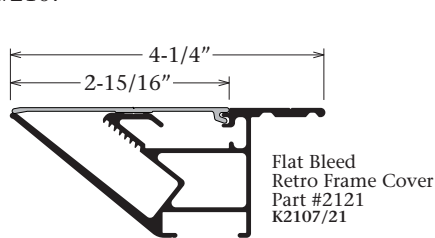

Size H'xW'	Mill Finish	Size H'xW'	Mill Finish	Size H'xW'	Mill Finish	Size H'xW'	Mill Finish
2 x 3	\$185	4 x 4	\$286	6 x 6	\$425	8 x 14	\$771
2 x 4	217	4 x 5	320	6 x 7	460	8 x 15	805
2 x 5	253	4 x 6	357	6 x 8	494	8 x 16	839
2 x 6	286	4 x 7	392	6 x 9	528	8 x 17	874
2 x 7	320	4 x 8	425	6 x 10	564	8 x 18	908
2 x 8	357	4 x 9	460	6 x 11	598	8 x 19	943
2 x 9	392	4 x 10	494	6 x 12	631	8 x 20	978
2 x 10	425	4 x 11	528	6 x 13	667		
2 x 11	460	4 x 12	564	6 x 14	701	9 x 9	631
2 x 12	494	4 x 13	598	6 x 15	736	9 x 10	667
2 x 13	528	4 x 14	631	6 x 16	771	9 x 11	701
2 x 14	564	4 x 15	667	6 x 17	805	9 x 12	736
2 x 15	598	4 x 16	701	6 x 18	839	9 x 13	771
2 x 16	631	4 x 17	736	6 x 19	874	9 x 14	805
2 x 17	667	4 x 18	771	6 x 20	908	9 x 15	839
2 x 18	701	4 x 19	805			9 x 16	874
2 x 19	736	4 x 20	839	7 x 7	494	9 x 17	908
2 x 20	771			7 x 8	528	9 x 18	943
		5 x 5	357	7 x 9	564	9 x 19	978
3 x 3	217	5 x 6	392	7 x 10	598	9 x 20	1011
3 x 4	253	5 x 7	425	7 x 11	631		
3 x 5	286	5 x 8	460	7 x 12	667	10 x 10	701
3 x 6	320	5 x 9	494	7 x 13	701	10 x 11	736
3 x 7	357	5 x 10	528	7 x 14	736	10 x 12	771
3 x 8	392	5 x 11	564	7 x 15	771	10 x 13	805
3 x 9	425	5 x 12	598	7 x 16	805	10 x 14	839
3 x 10	460	5 x 13	631	7 x 17	839	10 x 15	874
3 x 11	494	5 x 14	667	7 x 18	874	10 x 16	908
3 x 12	528	5 x 15	701	7 x 19	908	10 x 17	943
3 x 13	564	5 x 16	736	7 x 20	943	10 x 18	978
3 x 14	598	5 x 17	771			10 x 19	1011
3 x 15	631	5 x 18	805	8 x 8	564	10 x 20	1045
3 x 16	667	5 x 19	839	8 x 9	598		
3 x 17	701	5 x 20	874	8 x 10	631		
3 x 18	736			8 x 11	667		
3 x 19	771			8 x 12	701		
3 x 20	805			8 x 13	736		

Kits Include:

- Mill Finish
- Cut to size and mitered frames with covers
- Tension Clips
- All screws required to assemble by mechanical fastening
- All Corner Angles required
- Packaging
- Prices reflect one (1) Retro Frame Kit, SINGLE FACE APPLICATION

Not Included in Kits:

- Face
- Electrical Components
- Frame Support Tube - See optional accessories
- Frame Braces - See optional accessories
- Tension Tool - See optional accessories
- Mounting Provisions

Optional Accessories (pg 127):

- Frame Support Tube
- Frame Braces
- Tension Tool

Kit Specifications:

- Retro Frames and covers are cut .500" larger in both the height and width dimensions to allow for the Retro Frame attachment and give .250" tolerance for fit
- Custom size kits may be cut to any dimension
- Flexible face preparation - See page 129
- Frame Brace / Frame Support Tube placement - See page 130

Additional Information (pgs 196-197)

Note: All dimensions are subject to the tolerance standards of the aluminum extrusion industry. Profile drawings are illustrative and rounded to the nearest 1/16".

CURRENT PRICE as of April 1, 2022



COMMERCIAL

Unassembled Retro Frame Kits w/out Reveal - For Flexible Faces

Flat Bleed Retro Frame w/ Reflector Slot and Cover Options

Part #2103

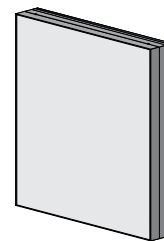
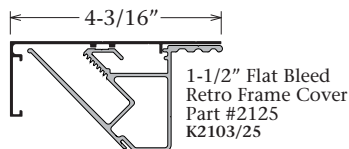
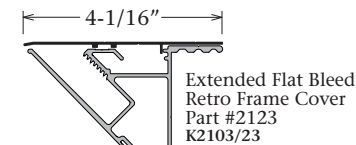
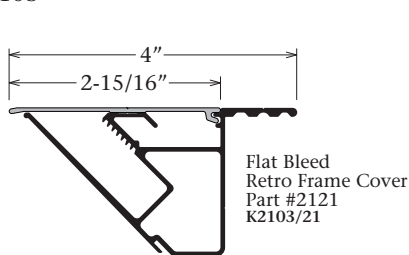

Size H'xW'	Mill Finish	Size H'xW'	Mill Finish	Size H'xW'	Mill Finish	Size H'xW'	Mill Finish
2 x 3	\$166	4 x 4	\$258	6 x 6	\$380	8 x 14	\$683
2 x 4	198	4 x 5	289	6 x 7	411	8 x 15	716
2 x 5	227	4 x 6	318	6 x 8	441	8 x 16	745
2 x 6	258	4 x 7	350	6 x 9	471	8 x 17	776
2 x 7	289	4 x 8	380	6 x 10	500	8 x 18	805
2 x 8	318	4 x 9	411	6 x 11	532	8 x 19	836
2 x 9	350	4 x 10	441	6 x 12	563	8 x 20	867
2 x 10	380	4 x 11	471	6 x 13	592		
2 x 11	411	4 x 12	500	6 x 14	623	9 x 9	563
2 x 12	441	4 x 13	532	6 x 15	653	9 x 10	592
2 x 13	471	4 x 14	563	6 x 16	683	9 x 11	623
2 x 14	500	4 x 15	592	6 x 17	716	9 x 12	653
2 x 15	532	4 x 16	623	6 x 18	745	9 x 13	683
2 x 16	563	4 x 17	653	6 x 19	776	9 x 14	716
2 x 17	592	4 x 18	683	6 x 20	805	9 x 15	745
2 x 18	623	4 x 19	716			9 x 16	776
2 x 19	653	4 x 20	745	7 x 7	441	9 x 17	805
2 x 20	683			7 x 8	471	9 x 18	836
		5 x 5	318	7 x 9	500	9 x 19	867
3 x 3	198	5 x 6	350	7 x 10	532	9 x 20	897
3 x 4	227	5 x 7	380	7 x 11	563		
3 x 5	258	5 x 8	411	7 x 12	592	10 x 10	623
3 x 6	289	5 x 9	441	7 x 13	623	10 x 11	653
3 x 7	318	5 x 10	471	7 x 14	653	10 x 12	683
3 x 8	350	5 x 11	500	7 x 15	683	10 x 13	716
3 x 9	380	5 x 12	532	7 x 16	716	10 x 14	745
3 x 10	411	5 x 13	563	7 x 17	745	10 x 15	776
3 x 11	441	5 x 14	592	7 x 18	776	10 x 16	805
3 x 12	471	5 x 15	623	7 x 19	805	10 x 17	836
3 x 13	500	5 x 16	653	7 x 20	836	10 x 18	867
3 x 14	532	5 x 17	683			10 x 19	897
3 x 15	563	5 x 18	716	8 x 8	500	10 x 20	928
3 x 16	592	5 x 19	745	8 x 9	532		
3 x 17	623	5 x 20	776	8 x 10	563		
3 x 18	653			8 x 11	592		
3 x 19	683			8 x 12	623		
3 x 20	716			8 x 13	653		

Kits Include:

- Mill Finish
- Cut to size and mitered frames with covers
- Tension Clips
- All screws required to assemble by mechanical fastening
- All Corner Angles required
- Packaging
- Prices reflect one (1) Retro Frame Kit, SINGLE FACE APPLICATION

Not Included in Kits:

- Face
- Electrical Components
- Frame Support Tube - See optional accessories
- Frame Braces - See optional accessories
- Tension Tool - See optional accessories
- Mounting Provisions

Optional Accessories (pg 127):

- Frame Support Tube
- Frame Braces
- Tension Tool

Kit Specifications:

- Retro Frames and covers are cut .500" larger in both the height and width dimensions to allow for the Retro Frame attachment and give .250" tolerance for fit
- Custom size kits may be cut to any dimension
- Flexible face preparation - See page 129
- Frame Brace / Frame Support Tube placement - See page 130

Additional Information (pgs 196-197)



US Patent Numbers 6,061,941 / 6,637,080
CA Patent Numbers 2,245,623 / 2,387,222

Unassembled Tension Frame Kits - For Flexible Faces

Wall Mount Tension Frame and Cover Options

Part #2090

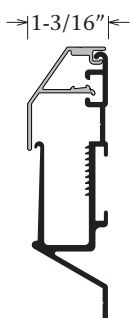

Wall Mount Tension Frame Beveled Cover Part #2091 K2090/91



Wall Mount Tension Frame Radius Cover Part #2089 K2090/89



Wall Mount Tension Frame Square Cover Part #2088 K2090/88

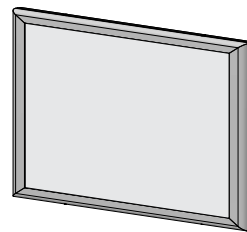

Size H'xW'	Mill Finish	Size H'xW'	Mill Finish	Size H'xW'	Mill Finish	Size H'xW'	Mill Finish
2 x 3	\$164	4 x 4	\$262	6 x 6	\$395	8 x 14	\$721
2 x 4	198	4 x 5	294	6 x 7	428	8 x 15	753
2 x 5	230	4 x 6	328	6 x 8	460	8 x 16	785
2 x 6	262	4 x 7	362	6 x 9	491	8 x 17	820
2 x 7	294	4 x 8	395	6 x 10	523	8 x 18	853
2 x 8	328	4 x 9	428	6 x 11	555	8 x 19	885
2 x 9	362	4 x 10	460	6 x 12	590	8 x 20	918
2 x 10	395	4 x 11	491	6 x 13	623		
2 x 11	428	4 x 12	523	6 x 14	655	9 x 9	590
2 x 12	460	4 x 13	555	6 x 15	689	9 x 10	623
2 x 13	491	4 x 14	590	6 x 16	721	9 x 11	655
2 x 14	523	4 x 15	623	6 x 17	753	9 x 12	689
2 x 15	555	4 x 16	655	6 x 18	785	9 x 13	721
2 x 16	590	4 x 17	689	6 x 19	820	9 x 14	753
2 x 17	623	4 x 18	721	6 x 20	853	9 x 15	785
2 x 18	655	4 x 19	753			9 x 16	820
2 x 19	689	4 x 20	785	7 x 7	460	9 x 17	853
2 x 20	721			7 x 8	491	9 x 18	885
		5 x 5	328	7 x 9	523	9 x 19	918
3 x 3	198	5 x 6	362	7 x 10	555	9 x 20	950
3 x 4	230	5 x 7	395	7 x 11	590		
3 x 5	262	5 x 8	428	7 x 12	623	10 x 10	655
3 x 6	294	5 x 9	460	7 x 13	655	10 x 11	689
3 x 7	328	5 x 10	491	7 x 14	689	10 x 12	721
3 x 8	362	5 x 11	523	7 x 15	721	10 x 13	753
3 x 9	395	5 x 12	555	7 x 16	753	10 x 14	785
3 x 10	428	5 x 13	590	7 x 17	785	10 x 15	820
3 x 11	460	5 x 14	623	7 x 18	820	10 x 16	853
3 x 12	491	5 x 15	655	7 x 19	853	10 x 17	885
3 x 13	523	5 x 16	689	7 x 20	885	10 x 18	918
3 x 14	555	5 x 17	721			10 x 19	950
3 x 15	590	5 x 18	753	8 x 8	523	10 x 20	982
3 x 16	623	5 x 19	785	8 x 9	555		
3 x 17	655	5 x 20	820	8 x 10	590		
3 x 18	689			8 x 11	623		
3 x 19	721			8 x 12	655		
3 x 20	753			8 x 13	689		

Kits Include:

- Mill Finish
- Cut to size and mitered frames with covers
- Tension Clips
- All screws required for cover
- All Corner Keys required
- Packaging

Not Included in Kits:

- Face
- Wall Mount Tension Tool - See optional accessories
- Mounting Provisions

Optional Accessories (pg 127):

- Wall Mount Tension Tool

Kit Specifications:

- Custom size kits may be cut to any dimension
- Flexible face preparation - See page 129

Additional Information (pgs 196-197)

Note: All dimensions are subject to the tolerance standards of the aluminum extrusion industry. Profile drawings are illustrative and rounded to the nearest 1/16".

CURRENT PRICE as of April 1, 2022



COMMERCIAL

Unassembled Single Face Kits - For Fabric Faces

1-1/4" Front Load Soft Signage Frame

Part #3092
K3092

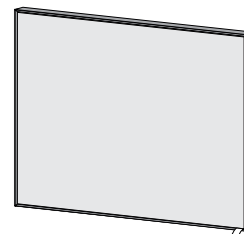
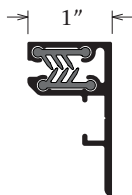

Size H"xW"	Mill Finish	Clear Anodized	Size H"xW"	Mill Finish	Clear Anodized	Size H"xW"	Mill Finish	Clear Anodized	Size H"xW"	Mill Finish	Clear Anodized
18 x 18	\$82	\$91	30 x 48	\$142	\$162	42 x 102	\$239	\$273	60 x 96	\$257	\$293
18 x 24	91	102	30 x 54	151	171	42 x 108	248	282	60 x 102	265	304
18 x 30	100	110	30 x 60	159	182	42 x 114	257	293	60 x 108	274	314
18 x 36	108	120	30 x 66	169	192	42 x 120	265	304	60 x 114	282	324
18 x 42	118	131	30 x 72	178	202				60 x 120	292	334
18 x 48	124	141	30 x 78	186	213	48 x 48	169	192			
18 x 54	134	151	30 x 84	195	223	48 x 54	178	202	72 x 72	239	273
18 x 60	142	162	30 x 90	203	233	48 x 60	186	213	72 x 78	248	282
18 x 66	151	171	30 x 96	213	243	48 x 66	195	223	72 x 84	257	293
18 x 72	159	182	30 x 102	221	254	48 x 72	203	233	72 x 90	265	304
18 x 78	169	192	30 x 108	230	264	48 x 78	213	243	72 x 96	274	314
18 x 84	178	202	30 x 114	239	273	48 x 84	221	254	72 x 102	282	324
18 x 90	186	213	30 x 120	248	282	48 x 90	230	264	72 x 108	292	334
18 x 96	195	223				48 x 96	239	273	72 x 114	301	345
18 x 102	203	233	36 x 36	134	151	48 x 102	248	282	72 x 120	309	355
18 x 108	213	243	36 x 42	142	162	48 x 108	257	293			
18 x 114	221	254	36 x 48	151	171	48 x 114	265	304	84 x 84	274	314
18 x 120	230	264	36 x 54	159	182	48 x 120	274	314	84 x 90	282	324
			36 x 60	169	192				84 x 96	292	334
24 x 24	100	110	36 x 66	178	202	54 x 54	186	213	84 x 102	301	345
24 x 30	108	120	36 x 72	186	213	54 x 60	195	223	84 x 108	309	355
24 x 36	118	131	36 x 78	195	223	54 x 66	203	233	84 x 114	318	365
24 x 42	124	141	36 x 84	203	233	54 x 72	213	243	84 x 120	325	376
24 x 48	134	151	36 x 90	213	243	54 x 78	221	254			
24 x 54	142	162	36 x 96	221	254	54 x 84	230	264	96 x 96	309	355
24 x 60	151	171	36 x 102	230	264	54 x 90	239	273	96 x 102	318	365
24 x 66	159	182	36 x 108	239	273	54 x 96	248	282	96 x 108	325	376
24 x 72	169	192	36 x 114	248	282	54 x 102	257	293	96 x 114	334	385
24 x 78	178	202	36 x 120	257	293	54 x 108	265	304	96 x 120	343	396
24 x 84	186	213				54 x 114	274	314			
24 x 90	195	223	42 x 42	151	171	54 x 120	282	324	108 x 108	343	396
24 x 96	203	233	42 x 48	159	182				108 x 114	352	406
24 x 102	213	243	42 x 54	169	192	60 x 60	203	233	108 x 120	361	416
24 x 108	221	254	42 x 60	178	202	60 x 66	213	243			
24 x 114	230	264	42 x 66	186	213	60 x 72	221	254	120 x 120	378	435
24 x 120	239	273	42 x 72	195	223	60 x 78	230	264			
			42 x 78	203	233	60 x 84	239	273			
30 x 30	118	131	42 x 84	213	243	60 x 90	248	282			
30 x 36	124	141	42 x 90	221	254						
30 x 42	134	151	42 x 96	230	264						

Kits Include:

- Mill Finish or Clear Anodized
- Cut to size and mitered frames
- Cut to size Grip Strips
- All 2 Piece Corner Keys required
- Fabric removal pull-tab with attachment screw
- Packaging

Not Included in Kits:

- Face or Back
- Tension Tool
- Soft Signage Frame Z-Clip - See optional accessories
- Mounting Provisions

Optional Accessories (pg 127):

- Soft Signage Frame Z-Clip

Kit Specifications:

- Custom size kits may be cut to any dimension
- Fabric face preparation - See page 129

Additional Information (pgs 196-197)

Unassembled Single Face Kits - For Fabric Faces

3-1/2" Front Load Soft Signage Frame

Part #3095
K3095

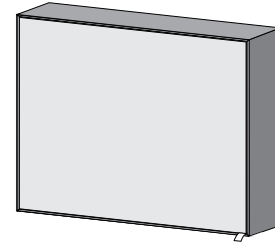
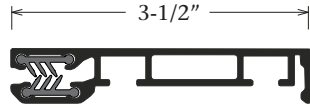

Size H"xW"	Mill Finish	Clear Anodized	Size H"xW"	Mill Finish	Clear Anodized	Size H"xW"	Mill Finish	Clear Anodized	Size H"xW"	Mill Finish	Clear Anodized
24 x 24	\$138	\$154	36 x 66	\$234	\$269	54 x 54	\$245	\$281	72 x 96	\$353	\$409
24 x 30	148	166	36 x 72	245	281	54 x 60	257	294	72 x 102	364	423
24 x 36	158	179	36 x 78	257	294	54 x 66	266	308	72 x 108	376	435
24 x 42	170	192	36 x 84	266	308	54 x 72	277	320	72 x 114	385	448
24 x 48	181	205	36 x 90	277	320	54 x 78	289	333	72 x 120	396	460
24 x 54	190	217	36 x 96	289	333	54 x 84	299	346			
24 x 60	202	230	36 x 102	299	346	54 x 90	309	357	78 x 78	332	384
24 x 66	213	243	36 x 108	309	357	54 x 96	321	371	78 x 84	343	397
24 x 72	223	257	36 x 114	321	371	54 x 102	332	384	78 x 90	353	409
24 x 78	234	269	36 x 120	332	384	54 x 108	343	397	78 x 96	364	423
24 x 84	245	281				54 x 114	353	409	78 x 102	376	435
24 x 90	257	294	42 x 42	202	230	54 x 120	364	423	78 x 108	385	448
24 x 96	266	308	42 x 48	213	243				78 x 114	396	460
24 x 102	277	320	42 x 54	223	257	60 x 60	266	308	78 x 120	408	474
24 x 108	289	333	42 x 60	234	269	60 x 66	277	320			
24 x 114	299	346	42 x 66	245	281	60 x 72	289	333	84 x 84	353	409
24 x 120	309	357	42 x 72	257	294	60 x 78	299	346	84 x 90	364	423
			42 x 78	266	308	60 x 84	309	357	84 x 96	376	435
			42 x 84	277	320	60 x 90	321	371	84 x 102	385	448
30 x 30	158	179	42 x 90	289	333	60 x 96	332	384	84 x 108	396	460
30 x 36	170	192	42 x 96	299	346	60 x 102	343	397	84 x 114	408	474
30 x 42	181	205	42 x 102	309	357	60 x 108	353	409	84 x 120	417	487
30 x 48	190	217	42 x 108	321	371	60 x 114	364	423			
30 x 54	202	230	42 x 114	332	384	60 x 120	376	435	96 x 96	396	460
30 x 60	213	243	42 x 120	343	397				96 x 102	408	474
30 x 66	223	257				66 x 66	289	333	96 x 108	417	487
30 x 72	234	269				66 x 72	299	346	96 x 114	429	500
30 x 78	245	281	48 x 48	223	257	66 x 78	309	357	96 x 120	440	511
30 x 84	257	294	48 x 54	234	269	66 x 84	321	371			
30 x 90	266	308	48 x 60	245	281	66 x 90	332	384	108 x 108	440	511
30 x 96	277	320	48 x 66	257	294	66 x 96	343	397	108 x 114	450	524
30 x 102	289	333	48 x 72	266	308	66 x 102	353	409	108 x 120	462	538
30 x 108	299	346	48 x 78	277	320	66 x 108	364	423			
30 x 114	309	357	48 x 84	289	333	66 x 114	376	435			
30 x 120	321	371	48 x 90	299	346	66 x 120	385	448	120 x 120	483	563
			48 x 96	309	357						
36 x 36	181	205	48 x 102	321	371						
36 x 42	190	217	48 x 108	332	384	72 x 72	309	357			
36 x 48	202	230	48 x 114	343	397	72 x 78	321	371			
36 x 54	213	243	48 x 120	353	409	72 x 84	332	384			
36 x 60	223	257				72 x 90	343	397			

Kits Include:

- Mill Finish or Clear Anodized
- Cut to size and mitered frames
- Cut to size Grip Strips
- All Soft Signage Angle Assemblies required
- Fabric removal pull-tab with attachment screw
- Packaging

Not Included in Kits:

- Face or Back
- Tension Tool
- Soft Signage Frame Z-Clip - See optional accessories
- Mounting Provisions
- Soft Signage Support - See optional accessories

Optional Accessories (pg 127):

- Soft Signage Frame Z-Clip
- Soft Signage Support

Kit Specifications:

- Custom size kits may be cut to any dimension
- Fabric face preparation - See page 129

Support Kits Include:

- Cut to size supports
- Soft Signage Angle Assemblies
- All screws required to assemble by mechanical fastening
- **Soft Signage Support, Part #3085, \$4.06 per/ft**

Additional Information (pgs 196-197)

Note: All dimensions are subject to the tolerance standards of the aluminum extrusion industry. Profile drawings are illustrative and rounded to the nearest 1/16".

CURRENT PRICE as of April 1, 2022



COMMERCIAL

Unassembled Single Face Kits - For Fabric Faces

1-1/4" Soft Signage Tension Frame and Plastic Cover

Part #3090N
K3090N

Part #3093N

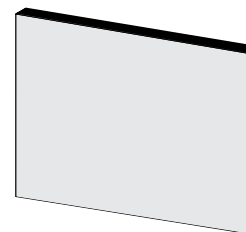
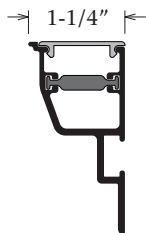

Size H"xW"	Black Cover	Size H"xW"	Black Cover	Size H"xW"	Black Cover	Size H"xW"	Black Cover
18 x 18	\$107	30 x 48	\$187	42 x 102	\$310	60 x 96	\$334
18 x 24	119	30 x 54	198	42 x 108	322	60 x 102	346
18 x 30	131	30 x 60	210	42 x 114	334	60 x 108	357
18 x 36	142	30 x 66	221	42 x 120	346	60 x 114	369
18 x 42	152	30 x 72	233			60 x 120	380
18 x 48	164	30 x 78	243	48 x 48	221		
18 x 54	175	30 x 84	255	48 x 54	233	72 x 72	310
18 x 60	187	30 x 90	265	48 x 60	243	72 x 78	322
18 x 66	198	30 x 96	277	48 x 66	255	72 x 84	334
18 x 72	210	30 x 102	289	48 x 72	265	72 x 90	346
18 x 78	221	30 x 108	301	48 x 78	277	72 x 96	357
18 x 84	233	30 x 114	310	48 x 84	289	72 x 102	369
18 x 90	243	30 x 120	322	48 x 90	301	72 x 108	380
18 x 96	255			48 x 96	310	72 x 114	392
18 x 102	265	36 x 36	175	48 x 102	322	72 x 120	403
18 x 108	277	36 x 42	187	48 x 108	334		
18 x 114	289	36 x 48	198	48 x 114	346	84 x 84	357
18 x 120	301	36 x 54	210	48 x 120	357	84 x 90	369
		36 x 60	221			84 x 96	380
24 x 24	131	36 x 66	233	54 x 54	243	84 x 102	392
24 x 30	142	36 x 72	243	54 x 60	255	84 x 108	403
24 x 36	152	36 x 78	255	54 x 66	265	84 x 114	415
24 x 42	164	36 x 84	265	54 x 72	277	84 x 120	425
24 x 48	175	36 x 90	277	54 x 78	289		
24 x 54	187	36 x 96	289	54 x 84	301	96 x 96	403
24 x 60	198	36 x 102	301	54 x 90	310	96 x 102	415
24 x 66	210	36 x 108	310	54 x 96	322	96 x 108	425
24 x 72	221	36 x 114	322	54 x 102	334	96 x 114	437
24 x 78	233	36 x 120	334	54 x 108	346	96 x 120	447
24 x 84	243			54 x 114	357		
24 x 90	255	42 x 42	198	54 x 120	369	108 x 108	447
24 x 96	265	42 x 48	210			108 x 114	459
24 x 102	277	42 x 54	221	60 x 60	265	108 x 120	471
24 x 108	289	42 x 60	233	60 x 66	277		
24 x 114	301	42 x 66	243	60 x 72	289	120 x 120	492
24 x 120	310	42 x 72	255	60 x 78	301		
		42 x 78	265	60 x 84	310		
30 x 30	152	42 x 84	277	60 x 90	322		
30 x 36	164	42 x 90	289				
30 x 42	175	42 x 96	301				

Kits Include:

- Mill Finish Frame
- Black Plastic Cover
- Cut to size and mitered frames and covers
- Cut to size Grip Strips
- All 2 Piece Corner Keys required
- Packaging

Not Included in Kits:

- Face or Back
- Tension Tool
- Soft Signage Frame Z-Clip - See optional accessories
- Mounting Provisions

Optional Accessories (pg 127):

- Soft Signage Frame Z-Clip

Kit Specifications:

- Custom size kits may be cut to any dimension
- Fabric face preparation - See page 129

Additional Information (pgs 196-197)

Unassembled Single Face Kits - For Fabric Faces

2" Soft Signage Tension Frame and Plastic Cover

Part #3090
K3090

Part #3093

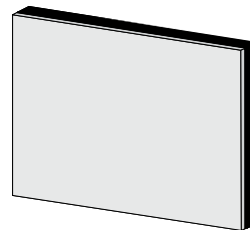
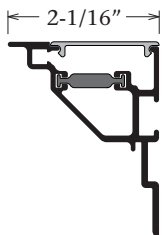

Size H"xW"	Black Cover	Size H"xW"	Black Cover	Size H"xW"	Black Cover	Size H"xW"	Black Cover
18 x 18	\$124	30 x 48	\$220	42 x 102	\$369	60 x 96	\$396
18 x 24	139	30 x 54	233	42 x 108	383	60 x 102	409
18 x 30	152	30 x 60	248	42 x 114	396	60 x 108	424
18 x 36	166	30 x 66	261	42 x 120	409	60 x 114	437
18 x 42	179	30 x 72	274			60 x 120	450
18 x 48	194	30 x 78	288	48 x 48	261		
18 x 54	207	30 x 84	302	48 x 54	274	72 x 72	369
18 x 60	220	30 x 90	316	48 x 60	288	72 x 78	383
18 x 66	233	30 x 96	328	48 x 66	302	72 x 84	396
18 x 72	248	30 x 102	341	48 x 72	316	72 x 90	409
18 x 78	261	30 x 108	355	48 x 78	328	72 x 96	424
18 x 84	274	30 x 114	369	48 x 84	341	72 x 102	437
18 x 90	288	30 x 120	383	48 x 90	355	72 x 108	450
18 x 96	302			48 x 96	369	72 x 114	463
18 x 102	316	36 x 36	207	48 x 102	383	72 x 120	478
18 x 108	328	36 x 42	220	48 x 108	396		
18 x 114	341	36 x 48	233	48 x 114	409	84 x 84	424
18 x 120	355	36 x 54	248	48 x 120	424	84 x 90	437
		36 x 60	261			84 x 96	450
24 x 24	152	36 x 66	274	54 x 54	288	84 x 102	463
24 x 30	166	36 x 72	288	54 x 60	302	84 x 108	478
24 x 36	179	36 x 78	302	54 x 66	316	84 x 114	491
24 x 42	194	36 x 84	316	54 x 72	328	84 x 120	506
24 x 48	207	36 x 90	328	54 x 78	341		
24 x 54	220	36 x 96	341	54 x 84	355	96 x 96	478
24 x 60	233	36 x 102	355	54 x 90	369	96 x 102	491
24 x 66	248	36 x 108	369	54 x 96	383	96 x 108	506
24 x 72	261	36 x 114	383	54 x 102	396	96 x 114	519
24 x 78	274	36 x 120	396	54 x 108	409	96 x 120	534
24 x 84	288			54 x 114	424		
24 x 90	302	42 x 42	233	54 x 120	437	108 x 108	534
24 x 96	316	42 x 48	248			108 x 114	547
24 x 102	328	42 x 54	261	60 x 60	316	108 x 120	560
24 x 108	341	42 x 60	274	60 x 66	328		
24 x 114	355	42 x 66	288	60 x 72	341	120 x 120	587
24 x 120	369	42 x 72	302	60 x 78	355		
		42 x 78	316	60 x 84	369		
30 x 30	179	42 x 84	328	60 x 90	383		
30 x 36	194	42 x 90	341				
30 x 42	207	42 x 96	355				

Kits Include:

- Mill Finish Frame
- Black Plastic Cover
- Cut to size and mitered frames and covers
- Cut to size Grip Strips
- All 2 Piece Corner Keys required
- Packaging

Not Included in Kits:

- Face or Back
- Tension Tool
- Soft Signage Frame Z-Clip - See optional accessories
- Mounting Provisions

Optional Accessories (pg 127):

- Soft Signage Frame Z-Clip

Kit Specifications:

- Custom size kits may be cut to any dimension
- Fabric face preparation - See page 129

Additional Information (pgs 196-197)

Note: All dimensions are subject to the tolerance standards of the aluminum extrusion industry. Profile drawings are illustrative and rounded to the nearest 1/16".

**CURRENT PRICE as
of April 1, 2022**



COMMERCIAL

Unassembled Single Face Kits - For Fabric Faces

1-1/4" Soft Signage Snap Tension Frame and Snap Cover

Part #3091N
K3091N/94

Part #3094N

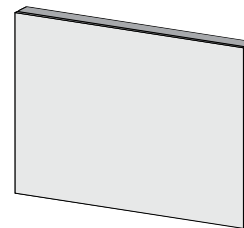
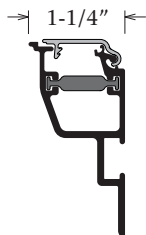

Size H"xW"	Mill Finish	Clear Anodized	Size H"xW"	Mill Finish	Clear Anodized	Size H"xW"	Mill Finish	Clear Anodized	Size H"xW"	Mill Finish	Clear Anodized
18 x 18	\$123	\$127	30 x 48	\$198	\$205	42 x 102	\$314	\$328	60 x 96	\$334	\$350
18 x 24	135	139	30 x 54	209	215	42 x 108	324	340	60 x 102	345	362
18 x 30	146	150	30 x 60	218	227	42 x 114	334	350	60 x 108	356	372
18 x 36	155	162	30 x 66	229	239	42 x 120	345	362	60 x 114	367	384
18 x 42	166	171	30 x 72	241	250				60 x 120	377	395
18 x 48	175	183	30 x 78	250	261	48 x 48	229	239			
18 x 54	186	195	30 x 84	262	273	48 x 54	241	250	72 x 72	314	328
18 x 60	198	205	30 x 90	273	282	48 x 60	250	261	72 x 78	324	340
18 x 66	209	215	30 x 96	282	294	48 x 66	262	273	72 x 84	334	350
18 x 72	218	227	30 x 102	292	306	48 x 72	273	282	72 x 90	345	362
18 x 78	229	239	30 x 108	302	318	48 x 78	282	294	72 x 96	356	372
18 x 84	241	250	30 x 114	314	328	48 x 84	292	306	72 x 102	367	384
18 x 90	250	261	30 x 120	324	340	48 x 90	302	318	72 x 108	377	395
18 x 96	262	273				48 x 96	314	328	72 x 114	387	406
18 x 102	273	282	36 x 36	186	195	48 x 102	324	340	72 x 120	397	421
18 x 108	282	294	36 x 42	198	205	48 x 108	334	350			
18 x 114	292	306	36 x 48	209	215	48 x 114	345	362	84 x 84	356	372
18 x 120	302	318	36 x 54	218	227	48 x 120	356	372	84 x 90	367	384
			36 x 60	229	239				84 x 96	377	395
24 x 24	146	150	36 x 66	241	250	54 x 54	250	261	84 x 102	387	406
24 x 30	155	162	36 x 72	250	261	54 x 60	262	273	84 x 108	397	416
24 x 36	166	171	36 x 78	262	273	54 x 66	273	282	84 x 114	408	428
24 x 42	175	183	36 x 84	273	282	54 x 72	282	294	84 x 120	419	440
24 x 48	186	195	36 x 90	282	294	54 x 78	292	306			
24 x 54	198	205	36 x 96	292	306	54 x 84	302	318	96 x 96	397	416
24 x 60	209	215	36 x 102	302	318	54 x 90	314	328	96 x 102	408	428
24 x 66	218	227	36 x 108	314	328	54 x 96	324	340	96 x 108	419	440
24 x 72	229	239	36 x 114	324	340	54 x 102	334	350	96 x 114	429	452
24 x 78	241	250	36 x 120	334	350	54 x 108	345	362	96 x 120	440	462
24 x 84	250	261				54 x 114	356	372			
24 x 90	262	273	42 x 42	209	215	54 x 120	367	384	108 x 108	440	462
24 x 96	273	282	42 x 48	218	227				108 x 114	450	474
24 x 102	282	294	42 x 54	229	239	60 x 60	273	282	108 x 120	462	484
24 x 108	292	306	42 x 60	241	250	60 x 66	282	294			
24 x 114	302	318	42 x 66	250	261	60 x 72	292	306	120 x 120	483	507
24 x 120	314	328	42 x 72	262	273	60 x 78	302	318			
			42 x 78	273	282	60 x 84	314	328			
30 x 30	166	171	42 x 84	282	294	60 x 90	324	340			
30 x 36	175	183	42 x 90	292	306						
30 x 42	186	195	42 x 96	302	318						

Kits Include:

- Mill Finish or Clear Anodized
- Cut to size and mitered frames and covers
- Cut to size Grip Strips
- All 2 Piece Corner Keys and Springs required
- Packaging

Not Included in Kits:

- Face or Back
- Tension Tool
- Soft Signage Frame Z-Clip - See optional accessories
- Mounting Provisions

Optional Accessories (pg 127):

- Soft Signage Frame Z-Clip

Kit Specifications:

- Custom size kits may be cut to any dimension
- Fabric face preparation - See page 129

Additional Information (pgs 196-197)

Unassembled Single Face Kits - For Fabric Faces

2" Soft Signage Snap Tension Frame and Snap Cover

Part #3091
K3091/94

Part #3094

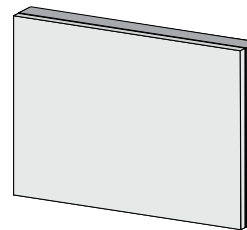
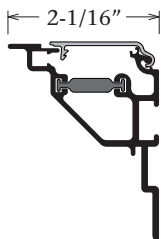

Size H"xW"	Mill Finish	Clear Anodized	Size H"xW"	Mill Finish	Clear Anodized	Size H"xW"	Mill Finish	Clear Anodized	Size H"xW"	Mill Finish	Clear Anodized
18 x 18	\$134	\$138	30 x 48	\$217	\$226	42 x 102	\$345	\$362	60 x 96	\$368	\$387
18 x 24	146	151	30 x 54	229	238	42 x 108	356	373	60 x 102	380	399
18 x 30	157	163	30 x 60	241	250	42 x 114	368	387	60 x 108	392	412
18 x 36	170	175	30 x 66	253	262	42 x 120	380	399	60 x 114	403	424
18 x 42	182	187	30 x 72	264	276				60 x 120	415	437
18 x 48	194	201	30 x 78	276	288	48 x 48	253	262			
18 x 54	205	213	30 x 84	288	301	48 x 54	264	276	72 x 72	345	362
18 x 60	217	226	30 x 90	299	312	48 x 60	276	288	72 x 78	356	373
18 x 66	229	238	30 x 96	310	325	48 x 66	288	301	72 x 84	368	387
18 x 72	241	250	30 x 102	321	337	48 x 72	299	312	72 x 90	380	399
18 x 78	253	262	30 x 108	333	349	48 x 78	310	325	72 x 96	392	412
18 x 84	264	276	30 x 114	345	362	48 x 84	321	337	72 x 102	403	424
18 x 90	276	288	30 x 120	356	373	48 x 90	333	349	72 x 108	415	437
18 x 96	288	301				48 x 96	345	362	72 x 114	427	448
18 x 102	299	312	36 x 36	205	213	48 x 102	356	373	72 x 120	439	462
18 x 108	310	325	36 x 42	217	226	48 x 108	368	387			
18 x 114	321	337	36 x 48	229	238	48 x 114	380	399	84 x 84	392	412
18 x 120	333	349	36 x 54	241	250	48 x 120	392	412	84 x 90	403	424
			36 x 60	253	262				84 x 96	415	437
24 x 24	157	163	36 x 66	264	276	54 x 54	276	288	84 x 102	427	448
24 x 30	170	175	36 x 72	276	288	54 x 60	288	301	84 x 108	439	462
24 x 36	182	187	36 x 78	288	301	54 x 66	299	312	84 x 114	450	474
24 x 42	194	201	36 x 84	299	312	54 x 72	310	325	84 x 120	462	487
24 x 48	205	213	36 x 90	310	325	54 x 78	321	337			
24 x 54	217	226	36 x 96	321	337	54 x 84	333	349	96 x 96	439	462
24 x 60	229	238	36 x 102	333	349	54 x 90	345	362	96 x 102	450	474
24 x 66	241	250	36 x 108	345	362	54 x 96	356	373	96 x 108	462	487
24 x 72	253	262	36 x 114	356	373	54 x 102	368	387	96 x 114	474	499
24 x 78	264	276	36 x 120	368	387	54 x 108	380	399	96 x 120	487	511
24 x 84	276	288				54 x 114	392	412			
24 x 90	288	301	42 x 42	229	238	54 x 120	403	424	108 x 108	487	511
24 x 96	299	312	42 x 48	241	250				108 x 114	499	523
24 x 102	310	325	42 x 54	253	262	60 x 60	299	312	108 x 120	510	536
24 x 108	321	337	42 x 60	264	276	60 x 66	310	325			
24 x 114	333	349	42 x 66	276	288	60 x 72	321	337	120 x 120	534	562
24 x 120	345	362	42 x 72	288	301	60 x 78	333	349			
			42 x 78	299	312	60 x 84	345	362			
30 x 30	182	187	42 x 84	310	325	60 x 90	356	373			
30 x 36	194	201	42 x 90	321	337						
30 x 42	205	213	42 x 96	333	349						

Kits Include:

- Mill Finish or Clear Anodized
- Cut to size and mitered frames and covers
- Cut to size Grip Strips
- All 2 Piece Corner Keys and Springs required
- Packaging

Not Included in Kits:

- Face or Back
- Tension Tool
- Soft Signage Frame Z-Clip - See optional accessories
- Mounting Provisions

Optional Accessories (pg 127):

- Soft Signage Frame Z-Clip

Kit Specifications:

- Custom size kits may be cut to any dimension
- Fabric face preparation - See page 129

Additional Information (pgs 196-197)







Note: All dimensions are subject to the tolerance standards of the aluminum extrusion industry. Profile drawings are illustrative and rounded to the nearest 1/16".

CURRENT PRICE as of April 1, 2022











COMMERCIAL

Commercial System Optional Accessories

Dividers	Part	Part Number	Cost Per/Ft Mill Finish	Cost Per/Ft Dk. Bronze
Cut To Size Dividers				
For Rigid Plastic Faces				
	1-1/2" Divider Included: • Screws for mechanical fastening • Divider Angles	K2133	\$5.48	\$7.14
	2" Divider Included: • Screws for mechanical fastening • Divider Angles	K2138	7.16	9.28
	2-3/4" Divider Included: • Screws for mechanical fastening • Divider Angles	K2128	10.14	13.24
	Flat 2" Divider Included: • Screws for mechanical fastening • Mounting Brackets	K2130	8.96	N/A
	1-1/4" Divider Included: • Screws for mechanical fastening • Divider Angles	K1662	5.81	N/A
For Rigid Plastic and/or Flexible Faces				
	Dual Divider 2-1/2" Dual Divider Cover Included: • Screws for mechanical fastening • Divider Corner Angles • Tension Clips	K2142/46	15.33	18.54

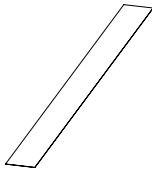
 UL Recognized Component Systems
The Underwriters Laboratory file number is E136850

Optional Extrusions	Part	Part Number	Cost Per Length Mill Finish
	Soft Signage Support Included: • Soft Signage Angle Assemblies	3085	\$4.06 (Cost Per/Ft)
	Frame Support Tube 3/4" x 1-5/8"	2175	108.53
	Small Frame Support Tube 1" x 1"	2177	88.05
	Z-Clip	3099	18.34
	Channel Letter Raceway U-Channel	1978	11.87

Components	Part Number	Price Each	Part Number	Price Each
	Wide Body Raceway Cover 10-1/4" x 48" x .040 (white)Blank	5116	\$32.27	 Tensioning Tool 5135 \$66.75
	Medium Body Raceway Cover 7-1/8" x 48" x .040 (white)Blank	5114	18.67	 Wall Mount Tensioning Tool 5137 66.75
	Single Face Body Raceway Cover 5-5/8" x 48" x .040 (white)Blank	5112	11.10	 Reverse Wall Mount Tensioning Tool 5138 66.75
	Wide Body Ballast Bracket 10-1/16" x 24" x .080	5092	12.63	 Compression Gasket 5500 18.56
	Medium Body Ballast Bracket 6-13/16" x 24" x .080	5094	8.39	Self adhesive water exclusion gasket 50' roll
	Single Face Body Ballast Bracket 5-9/16" x 24" x .080	5096	6.28	

Commercial System Optional Accessories

6"	9"	Part	Part Number	Price/box of four (4) assemblies	6"	9"	Part	Part Number	Price/box of four (4) assemblies
Radius Corners For Rigid Plastic Faces 1-1/2" Retainer					For Flexible Faces Tension Frame w/ Bleed Tension Frame Cover				
		Narrow S/F Body	6" 4465	\$460.65			Narrow S/F Body	6" 4485	\$484.75
		Single Face Body	6" 4565 9" 4560	460.65 504.59			Single Face Body	6" 4585 9" 4580	484.75 516.66
		Medium Body	6" 4535 9" 4530	643.77 712.86			Medium Body	6" 4555 9" 4550	570.83 724.99
		Wide Body	6" 4505 9" 4500	676.49 752.91			Wide Body	6" 4525 9" 4520	631.20 766.66
<p>Note: 1-1/2" Radius Corners are for use with Part #2055, 1-1/2" Retainer only. Body and retainers are cast aluminum.</p>					<p>Note: Bleed Tension Frame Radius Corners are for use with Parts #2085/#2095, Bleed Tension Frame and Bleed Tension Frame Cover only. The Covers are injection molded polycarbonate, pre-primed black and ready for paint/top coating.</p>				
For Rigid Plastic or Flexible Faces Dual Frame w/ 2-1/4" Dual Frame Cover					For Flexible Faces Tension Frame II w/ Bleed Tension Frame Cover				
		Narrow S/F Body	6" 4475	490.91			Narrow S/F Body	6" 4488	510.32
		Single Face Body	6" 4575 9" 4570	490.91 525.01			Single Face Body	6" 4588 9" 4587	510.32 557.50
		Medium Body	6" 4545 9" 4540	685.81 741.66			Medium Body	6" 4558 9" 4557	623.18 815.51
		Wide Body	6" 4515 9" 4510	723.13 783.33			Wide Body	6" 4528 9" 4527	678.57 854.94
<p>Note: Dual Frame Radius Corners are for use with either Part #2045, 2-1/4" Retainer or Parts #2065/#2075, Dual Frame with 2-1/4" Dual Frame Cover. The Covers are injection molded polycarbonate, pre-primed black and ready for paint/top coating.</p>					<p>Note: Bleed Tension Frame Radius Corners are for use with Parts #2086/#2095, Bleed Tension Frame and Bleed Tension Frame Cover only. The Covers are injection molded polycarbonate, pre-primed black and ready for paint/top coating.</p>				

Components	Part	Part Number	Price Each
Gas Supports 	Gas Support Included: (2) Gas Supports/Ball Stud Mounting Brackets (4) 10mm Ball Studs Screws for mechanical fastening Designed for SignComp Large Vandal only. Not recommended with other systems. Call Customer Service for specific gas support size and poundage.	K5934	\$87.23

Note: The cast radius corner body is ground smooth and milled to fit the extrusion profile. Grind lines and imperfections are present. Some surface preparation may be necessary. **Not ready for paint.** All corners are mill finish and packaged four (4) per box, unless requested otherwise.

Note: All dimensions are subject to the tolerance standards of the aluminum extrusion industry. Profile drawings are illustrative and rounded to the nearest 1/16".



Flexible and Fabric Face Preparation

Tension Clip and Flexible Face Requirements

Frame Type (Part # - Name)	Face Trim Size "ADD" to overall Height and Width of the assembled frame.	Clip Line "DEDUCT" from trim size on all (4) four sides.	Clip Placement (on Center)	Tension Tool (Part #)
#2065 - Dual Frame	3"	1-1/2"	6"	5135
#2085 - Tension Frame	6"	1-1/2"	5"	5135
#2086 - Tension Frame II	6-1/2"	1-1/2"	5"	5135
#2090 - Wall Mount Tension Frame	4-1/2"	2-1/4"	5"	5137/5138
#2092 - Bleed Fascia Frame	6"	1-1/2"	5"	5135
#2094 - 1-1/2" Fascia Frame	3"	1-1/2"	6"	5135
#2103 - Flat Bleed Retro Frame w/ Reflector Slot	6-1/2"	1-1/2"	5"	5135
#2104 - Flat Bleed Retro Frame	6-1/2"	1-1/2"	5"	5135
#2105 - Bleed Retro Frame	6"	1-1/2"	5"	5135
#2107 - Flat Bleed Retro Frame II	7"	1-1/2"	5"	5135
#2112 - 2" Retro Frame	3"	1-1/2"	6"	5135
#2142 - Dual Divider	3"	1-1/2"	5"	5135
#2230 - Flat Bleed Double Face Tension Body	6-1/2"	1-1/2"	5"	5135
#2233 - 6" Flat Bleed Single Face Tension Body	13"	1-1/2"	5"	5135

Note: See the Tensioning Instructions for additional details.

Fabric Face Requirements

Frame Type (Part # - Name)	Face Trim Size "ADD" to overall Height and Width of the assembled frame.
#3090N - 1-1/4" Soft Signage Tension Frame	2"- 3"
#3091N - 1-1/4" Soft Signage Snap Tension Frame	2"- 3"
#3090 - 2" Soft Signage Tension Frame	2"- 3"
#3091 - 2" Soft Signage Snap Tension Frame	2"- 3"
#3092 - 1-1/4" Front Load Soft Signage Frame	1"- 2"
#3095 - 3-1/2" Front Load Soft Signage Frame	1"- 2"

Frame Brace and Frame Support Tube Placement

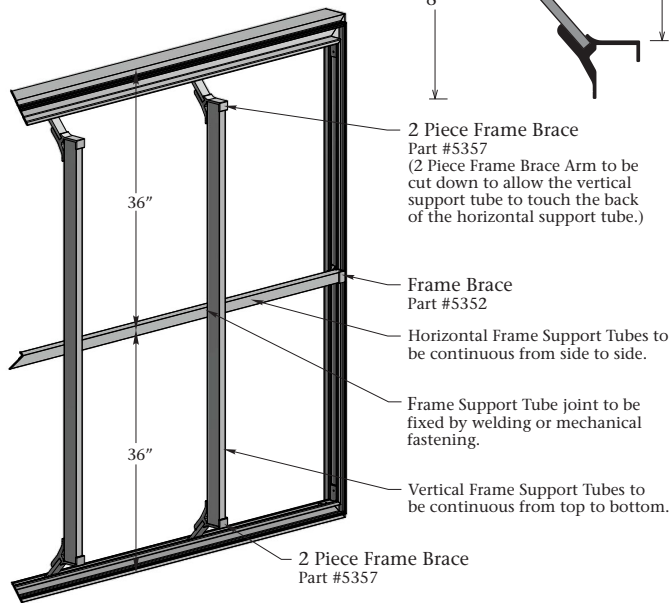
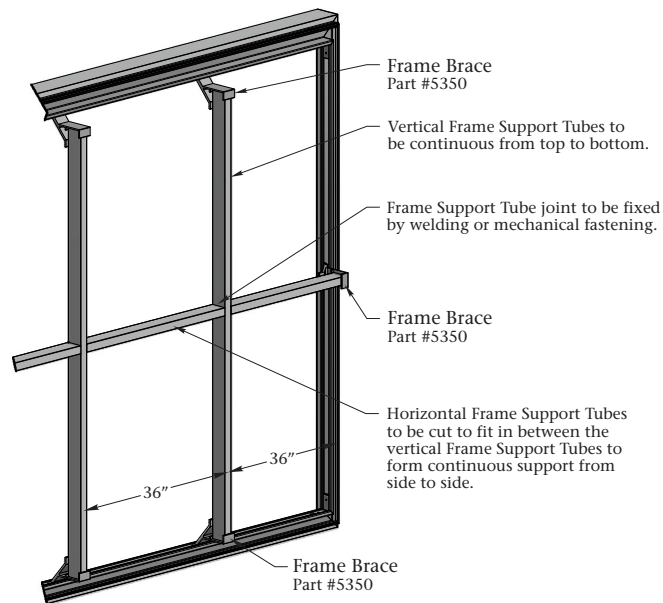
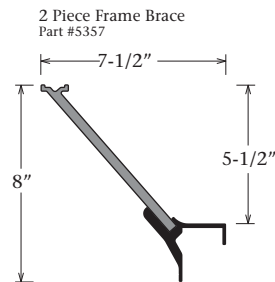
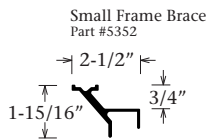
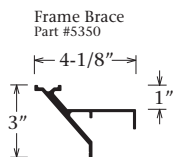

Compression Bracing for Flexible Vinyl Faces

Dual Frame, Tension Frame & Dual Divider

Place a vertical Frame Brace and Frame Support Tube approximately every 36" on center. Cut and insert horizontal pieces of Frame Support Tube approximately every 36" in between the vertical assemblies.

Retro Frames

Applications where the Retro Frame carries the compression load, placement of the Frame Brace and Frame Support Tube is the same as the Dual Frame, Tension Frame and Dual Divider.

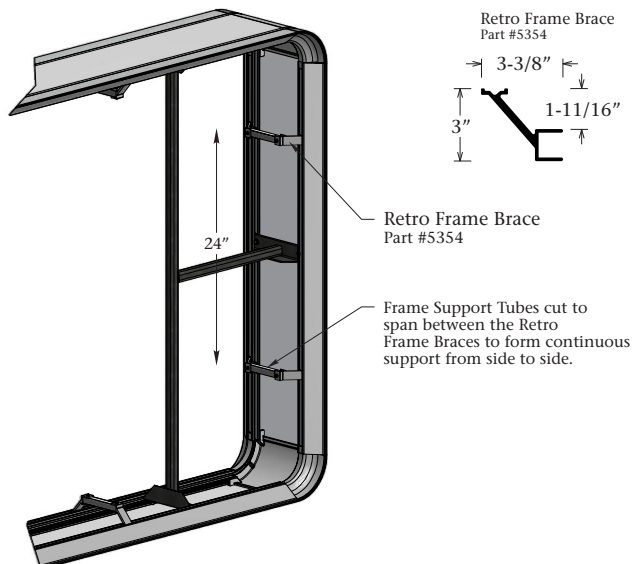

Wind Bracing for Rigid Faces

2-1/4" Retainer & Dual Frame

The Frame Brace and Frame Support Tube may be used to tie the top retainer to the bottom retainer for large hingeable face applications.

1-1/2" Divider

Place a minimum of one (1) vertical Frame Brace and Frame Support Tube in the center of each 10' span.

Note: 10' span for one assembly / 16' span for two assemblies.

2" Divider & 2-3/4" Divider

Place a minimum of one (1) vertical Frame Brace and Frame Support Tube in the center of each 12' span.

Note: 12' span for one assembly / 18' span for two assemblies.

Retro Bracing

Place a Retro Frame Brace and 1" Frame Support Tube approximately every 24" on center around the perimeter of the cabinet. This bracing option may be used when there IS adequate structure in the cabinet and the frames are NOT required to hinge.

- Medium Body will accept a 3" square steel support tube and Wide Body will accept a 6" steel support, both accommodate the perpendicular placement of Frame Braces and Frame Support Tube
- Do not place the Frame Brace and Frame Support Tube directly in front of parallel steel support structures
- Place all Frame Braces and Frame Support Tubes directly in between parallel lamps
- Frame Braces and Frame Support Tubes that are perpendicular to lamps will not cause shadows
- Frame Brace configuration in cabinets is dependant on the body, frame, support size and lighting source being used

Architectural Products

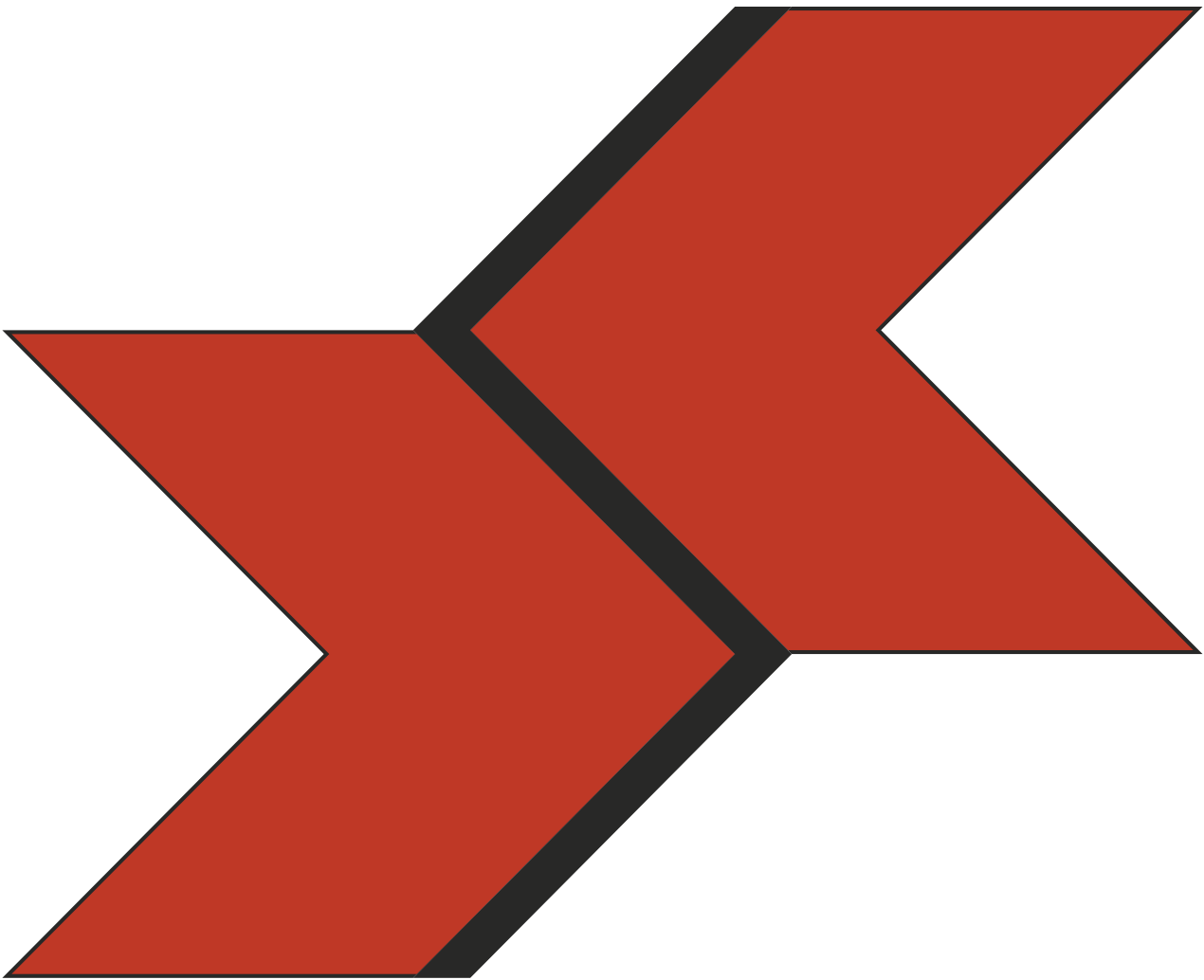

Unassembled Series 1 Kits - For Rigid Faces

Post & Panel Systems for 1/8" Faces

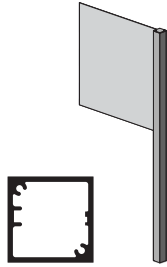

2" Square Post
Part #1000
K1000

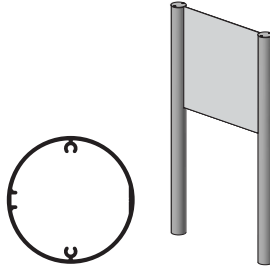

3-1/4" Round Post
Part #1007
K1007

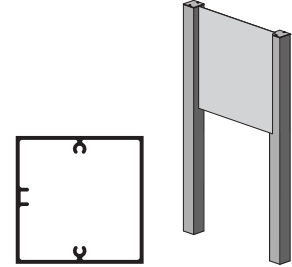

3-1/4" Square Post
Part #1005
K1005

2" Single Post		3-1/4" Single Post		2" Double Post		3-1/4" Double Post	
Size H"xW"	Mill Finish	Size H"xW"	Mill Finish	Size H"xW"	Mill Finish	Size H"xW"	Mill Finish
12 x 12	\$167	12 x 12	\$231	12 x 12	\$304	12 x 12	\$356
12 x 18	167	12 x 18	231	12 x 18	304	12 x 18	356
18 x 12	173	18 x 12	236	12 x 24	304	12 x 24	356
18 x 18	173	18 x 18	236	12 x 30	304	12 x 30	356
24 x 12	178	24 x 12	242	12 x 36	304	12 x 36	356
24 x 18	178	24 x 18	242	12 x 48	304	12 x 48	356
30 x 12	183	30 x 12	250	18 x 18	308	18 x 18	362
30 x 18	183	30 x 18	250	18 x 24	308	18 x 24	362
36 x 12	189	36 x 12	255	18 x 30	308	18 x 30	362
36 x 18	189	36 x 18	255	18 x 36	308	18 x 36	362
48 x 12	197	48 x 12	259	18 x 48	308	18 x 48	362
48 x 18	197	48 x 18	259	24 x 24	314	24 x 24	367
				24 x 30	314	24 x 30	367
				24 x 36	314	24 x 36	367
				24 x 48	314	24 x 48	367
				30 x 30	320	30 x 30	371
				30 x 36	320	30 x 36	371
				30 x 48	320	30 x 48	371
				36 x 36	325	36 x 36	380
				36 x 48	325	36 x 48	380
				48 x 48	330	48 x 48	384

Single Post Kits Include:

- Mill finish
- One (1) 95-5/8" pre-slotted post
- One (1) slightly oversized cap and screws
- Packaging

Double Post Kits Include:

- Mill finish
- Two (2) 95-5/8" pre-slotted posts
- Two (2) slightly oversized caps and screws
- Packaging
- For 12' Posts: Add \$47.00 for 2" posts, \$56.00 for 3-1/4" posts
- Additional post length: Add \$20.00 per linear foot for 2" posts, \$22.00 per linear foot for 3-1/4" posts

Not Included in Kits:

- Aluminum faces
- Locking strips or attachment screws

Kit Specifications:

- Custom size kits may be cut to any dimension
- Faces are designed to fit just below the cap

Additional Information (pgs 196-197)

Note: All dimensions are subject to the tolerance standards of the aluminum extrusion industry. Profile drawings are illustrative and rounded to the nearest 1/16".

CURRENT PRICE as of April 1, 2022



Unassembled Copy Bar Kits

2" Copy Bar System

K1400

Reveal



CB Reveal Part #1410

Copy Bar Options

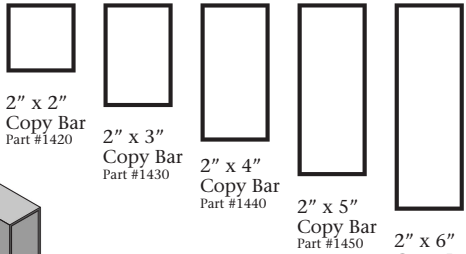

2" x 2" Copy Bar Part #1420

2" x 3" Copy Bar Part #1430

2" x 4" Copy Bar Part #1440

2" x 5" Copy Bar Part #1450

2" x 6" Copy Bar Part #1460

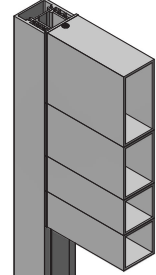

One Reveal Shape:

- Fits into all five (5) Copy Bars
- Slides into Series 2, 3 & 4 posts
- Delivers three (3) reveal positions

Copy Bar Kits

Copy Bar Length (inches)	2" x 2" Copy Bar Mill Finish	2" x 3" Copy Bar Mill Finish	2" x 4" Copy Bar Mill Finish	2" x 5" Copy Bar Mill Finish	2" x 6" Copy Bar Mill Finish
24	\$36	\$47	\$55	\$62	\$68
30	45	55	62	71	82
36	52	62	71	83	94
48	62	75	90	104	119
60	76	90	107	124	139
72	87	122	143	166	189
84	98	127	154	178	201
96	107	135	162	189	213

Copy Bar Kits Include:

- Mill Finish
- Cut to length Copy Bar(s) w/ two (2) Series CB Reveals (Pre-drilled and countersunk)
- All screws for assembly of Reveals to Copy Bars
- Packaging

Not included in Kits:

- Posts
- Attachment of Series CB Reveals

Series 2, 3, 4 & 7 Post Kits

*Offered in Pre-painted Dark Bronze finish

Posts

Series 2



Square Part #1100 K1100

Series 3



Radius Part #1210 K1210



Rectangular Part #1220 K1220



Triangular Part #1240 K1240

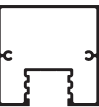

Square Part #1233 K1233



Round Part #1237 K1237



Rectangular w/ Radius Edges Part #1230 K1230



Triangular w/ Radius Edges Part #1250 K1250

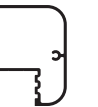

Square w/ Radius Edges Part #1235 K1235

Series 4

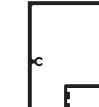

Square Part #1333 K1333



Round Part #1337 K1337



Round 90° Part #1339 K1339



Round 4-sided Part #1338 K1338

Panel Adaptors



1/8" Panel Adaptor Part #1203 K1203



1/4" Panel Adaptor Part #1202 K1202



1/2" Panel Adaptor Part #1204 K1204

Reveal



Reveal Part #1200

Post Filler



Round Post Filler Part #1201

Series 7



Radius Part #1500 K1500

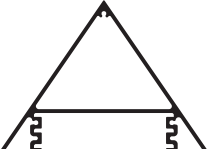

Triangular Part #1530 K1530

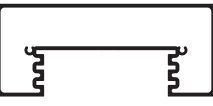

Rectangular Part #1510 K1510



Reveal Part #1550

Series 2, 2" Square Post

\$304.00 for 2 - 95-5/8" posts & caps
 \$434.00 for 2 - 143-5/8" posts & caps
 Additional post length -
 Add \$24.00 per/ft per/post

*Dk. Bronze -
 Add \$4.00 per/ft per/post

Series 3 Posts - Radius, Rectangular & Triangular

\$334.00 for 2 - 95-5/8" posts & caps
 \$487.00 for 2 - 143-5/8" posts & caps
 Additional post length -
 Add \$27.00 per/ft per/post

*Dk. Bronze -
 Add \$4.00 per/ft per/post

Series 3 Posts - Square & Round

\$395.00 for 2 - 95-5/8" posts & caps
 \$594.00 for 2 - 143-5/8" posts & caps
 Additional post length -
 Add \$31.00 per/ft per/post

Series 4 Posts - Square & Round

\$434.00 for 2 - 95-5/8" posts & caps
 \$654.00 for 2 - 143-5/8" posts & caps
 Additional post length -
 Add \$34.00 per/ft per/post

Series 7 Posts - Radius, Rectangular & Triangular

\$681.00 for 2 - 95-5/8" posts & caps
 \$987.00 for 2 - 143-5/8" posts & caps
 Additional post length -
 Add \$55.00 per/ft per/post

Post Kits Include:

- Two (2) Mill Finish or Dk. Bronze cut to size posts
- Two (2) slightly oversized caps and screws w/ adjustable reveal
- Full reveal or cut-to-size reveal for the panel
- Cut-to-size reveal for "below the panel filler" (Below the panel filler is cut to fit 6" below grade)
- Packaging

Panel Adaptor Kits Include:

- Two (2) Mill Finish or Dk. Bronze cut to size posts
- Two (2) slightly oversized caps and screws w/ adjustable reveal
- Full Panel Adaptor or cut to size Panel Adaptor
- Cut-to-size reveal for "below the panel filler" (Below the panel filler is cut to fit 6" below grade)
- Packaging

Not Included in Kits:

- Aluminum faces
- Internal Supports (Internal bracing may be required for panels overs 30 square feet)

ARCHITECTURAL

Unassembled Series 2 Kits - For Rigid Faces

2" Post & Panel Systems



Slide Body
Part #1110
K1110



Bleed Body
Part #1120
K1120



Frameless Body
Part #1125
K1125



Beveled Frame
Part #1990
K1990

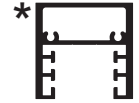

2" Square Post
Part #1100

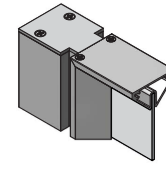
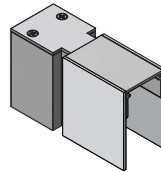
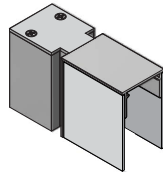
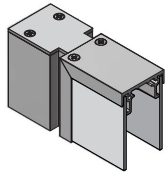

Without Posts

With Posts

Without Posts			Without Posts			With Posts			With Posts		
Size H"xW"	Mill Finish	Dk. Bronze	Size H"xW"	Mill Finish	Dk. Bronze	Size H"xW"	Mill Finish	Dk. Bronze	Size H"xW"	Mill Finish	Dk. Bronze
12 x 12	\$67	\$78	30 x 30	\$107	\$138	12 x 12	\$368	\$480	30 x 30	\$409	\$542
12 x 24	83	100	30 x 36	118	148	12 x 24	381	500	30 x 36	415	548
12 x 36	96	119	30 x 48	127	164	12 x 36	395	522	30 x 48	429	567
12 x 48	107	138	30 x 60	139	183	12 x 48	409	542	30 x 60	443	586
12 x 60	123	152	30 x 72	155	203	12 x 60	421	555	30 x 72	456	606
12 x 72	135	174	30 x 84	167	221	12 x 72	434	578	30 x 84	469	622
12 x 84	151	195	30 x 96	183	239	12 x 84	450	597	30 x 96	484	643
12 x 96	162	209	30 x 108	195	257	12 x 96	464	614	30 x 108	496	662
			30 x 120	209	276				30 x 120	511	678
18 x 18	83	100	36 x 36	123	152	18 x 18	381	500	36 x 36	421	555
18 x 24	88	108	36 x 48	135	174	18 x 24	387	514	36 x 48	434	578
18 x 30	96	119	36 x 60	151	195	18 x 30	395	522	36 x 60	450	597
18 x 36	103	131	36 x 72	162	209	18 x 36	400	528	36 x 72	464	614
18 x 48	118	148	36 x 84	175	230	18 x 48	415	548	36 x 84	478	631
18 x 60	127	164	36 x 96	189	250	18 x 60	429	567	36 x 96	488	651
18 x 72	139	183	36 x 108	202	266	18 x 72	443	586	36 x 108	502	667
18 x 84	155	203	36 x 120	214	285	18 x 84	456	606	36 x 120	518	690
18 x 96	167	221				18 x 96	469	622			
24 x 24	96	119	48 x 48	151	195	24 x 24	395	522	48 x 48	450	597
24 x 30	103	131	48 x 60	162	209	24 x 30	400	528	48 x 60	464	614
24 x 36	107	138	48 x 72	175	230	24 x 36	409	542	48 x 72	478	631
24 x 48	123	152	48 x 84	189	250	24 x 48	421	555	48 x 84	488	651
24 x 60	135	174	48 x 96	202	266	24 x 60	434	578	48 x 96	502	667
24 x 72	151	195				24 x 72	450	597			
24 x 84	162	209				24 x 84	464	614			
24 x 96	175	230				24 x 96	478	631			
24 x 108	189	250				24 x 108	488	651			
24 x 120	202	266				24 x 120	502	667			

Kits Include:

- Mill finish or Dk. Bronze
- Cut to size and mitered bodies (Slide Body and Beveled Frame are pre-drilled and countersunk)
- Bleed Body, Frameless Body and 1/4 Round Body are designed for welded assembly
- All screws required to assemble by mechanical fastening
- All Corner Angles and/or Corner Keys required
- Packaging

Kits w/ Posts Include:

- Two (2) 95-5/8" posts
- Two (2) slightly oversized caps and screws with adjustable reveal for zero, 3/8" or 3/4" positions
- Cut-to-size reveal and "below the panel filler" (Below the panel filler is cut to fit 6" below grade)
- For 12' Posts Add - Mill Finish \$124.00 and Dk. Bronze \$159.00
- Additional post length - Mill Finish \$24.00 and Dk. Bronze \$28.00 per linear foot
- Additional post options - See page 133

Not Included in Kits:

- Aluminum faces
- Internal Supports (Internal bracing may be required for panels over 30 square feet)

Kit Specifications:

- Custom size kits may be cut to any dimension

Additional Information (pgs 196-197)

*Dk. Bronze offering - Slide Body, Beveled Frame, Reveal and Square Posts with caps and screws only.

Note: All dimensions are subject to the tolerance standards of the aluminum extrusion industry. Profile drawings are illustrative and rounded to the nearest 1/16".

CURRENT PRICE as of April 1, 2022



Unassembled Series 3 Kits - For Rigid Faces

1-5/8" Wall Mount Systems



1/2 Slide Body
Part #1265
K1265

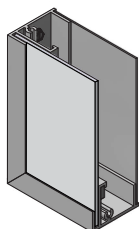

1/4 Round End (Optional)
Part #1215

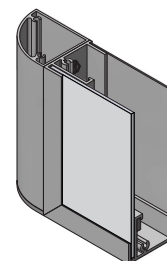

Without Ends

With Ends

Size H"xW"	Mill Finish	Price	Size H"xW"	Mill Finish	Price	Size H"xW"	Mill Finish	Price	
12 x 24	\$138		30 x 30	\$159		12 x 24	\$162	30 x 30	\$202
12 x 36	152		30 x 36	166		12 x 36	170	30 x 36	207
12 x 48	159		30 x 48	175		12 x 48	183	30 x 48	218
12 x 60	170		30 x 60	186		12 x 60	190	30 x 60	227
12 x 72	183		30 x 72	195		12 x 72	202	30 x 72	236
12 x 84	190		30 x 84	207		12 x 84	213	30 x 84	248
12 x 96	202		30 x 96	218		12 x 96	225	30 x 96	258
			30 x 108	227				30 x 108	265
			30 x 120	236				30 x 120	280
18 x 18	138					18 x 18	167		
18 x 24	150					18 x 24	173		
18 x 30	152		36 x 36	170		18 x 30	178	36 x 36	218
18 x 36	155		36 x 48	183		18 x 36	185	36 x 48	229
18 x 48	166		36 x 60	190		18 x 48	192	36 x 60	239
18 x 60	175		36 x 72	202		18 x 60	203	36 x 72	249
18 x 72	186		36 x 84	210		18 x 72	213	36 x 84	259
18 x 84	195		36 x 96	223		18 x 84	225	36 x 96	265
18 x 96	207		36 x 108	230		18 x 96	231	36 x 108	281
			36 x 120	241				36 x 120	289
24 x 24	152		36 x 132	255		24 x 24	185	36 x 132	296
24 x 30	155		36 x 144	261		24 x 30	190	36 x 144	312
24 x 36	159					24 x 36	195		
24 x 48	170		48 x 48	190		24 x 48	203	48 x 48	255
24 x 60	183		48 x 60	202		24 x 60	214	48 x 60	261
24 x 72	190		48 x 72	210		24 x 72	227	48 x 72	273
24 x 84	202		48 x 84	223		24 x 84	234	48 x 84	282
24 x 96	210		48 x 96	230		24 x 96	248	48 x 96	292
24 x 108	223		48 x 108	241		24 x 108	257	48 x 108	304
24 x 120	230		48 x 120	255		24 x 120	264	48 x 120	314
			48 x 132	261				48 x 132	322
			48 x 144	273				48 x 144	334

Kits Include:

- Mill finish
- Cut to size and mitered bodies (1/2 Slide Body is pre-drilled and countersunk)
- All screws required to assemble by mechanical fastening
- All Corner Keys required
- Packaging

Kits w/ Ends Include:

- Two (2) 1/4 Round Ends
- Four (4) slightly over sized caps and screws (Two (2) right and two (2) left)
- 1/4 Round End attachment screws

Not Included in Kits:

- Aluminum face or back
- Internal Supports (Internal bracing may be required for panels over 30 square feet)

Kit Specifications:

- Custom size kits may be cut to any dimension
- 1/4 Round Ends cut .25" shorter than cabinet height

Additional Information (pgs 196-197)

Unassembled Series 3 Kits - For Rigid Faces

3-1/4" Post & Panel Systems



Slide Body
Part #1260
K1260

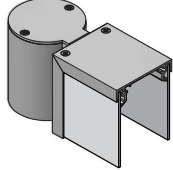

Bleed Body
Part #1270
K1270

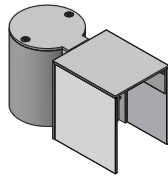

Frameless Body
Part #1275
K1275

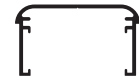
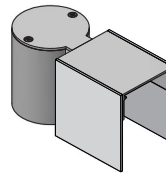

1/4 Round Body
Part #1280
K1280

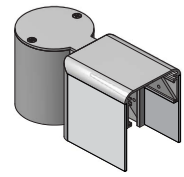

Part #1210



Part #1237

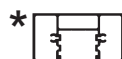

Part #1220



Part #1230

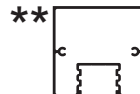

Part #1233

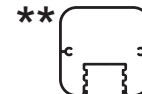

Part #1235



Part #1240

Without Posts

With Posts

Size H"xW"	Mill Finish	Dk. Bronze	Size H"xW"	Mill Finish	Dk. Bronze	Size H"xW"	Mill Finish	Dk. Bronze	Size H"xW"	Mill Finish	Dk. Bronze
12 x 12	\$83	\$100	30 x 30	\$143	\$178	12 x 12	\$413	\$571	30 x 30	\$474	\$651
12 x 24	103	124	30 x 36	154	195	12 x 24	434	597	30 x 36	485	664
12 x 36	123	151	30 x 48	175	221	12 x 36	455	622	30 x 48	507	692
12 x 48	143	178	30 x 60	195	248	12 x 48	474	651	30 x 60	524	720
12 x 60	163	205	30 x 72	214	273	12 x 60	496	678	30 x 72	548	748
12 x 72	185	234	30 x 84	234	304	12 x 72	518	704	30 x 84	567	773
12 x 84	207	261	30 x 96	258	330	12 x 84	536	730	30 x 96	587	797
12 x 96	227	286	30 x 108	280	356	12 x 96	575	756	30 x 108	610	825
			30 x 120	294	381				30 x 120	629	853
18 x 18	103	124				18 x 18	434	597			
18 x 24	114	138	36 x 36	163	205	18 x 24	444	613	36 x 36	496	678
18 x 30	123	151	36 x 48	185	236	18 x 30	455	622	36 x 48	518	704
18 x 36	134	166	36 x 60	207	261	18 x 36	467	638	36 x 60	536	730
18 x 48	154	195	36 x 72	227	286	18 x 48	485	664	36 x 72	555	756
18 x 60	175	221	36 x 84	248	314	18 x 60	507	692	36 x 84	578	784
18 x 72	195	248	36 x 96	264	340	18 x 72	524	720	36 x 96	599	813
18 x 84	214	273	36 x 108	289	367	18 x 84	548	748	36 x 108	618	839
18 x 96	234	304	36 x 120	310	395	18 x 96	567	773	36 x 120	639	867
			36 x 132	327	423				36 x 132	661	891
			36 x 144	350	450				36 x 144	681	920
24 x 24	123	151				24 x 24	455	622			
24 x 30	134	166	48 x 48	207	261	24 x 30	467	638	48 x 48	536	730
24 x 36	143	178	48 x 60	227	286	24 x 36	474	651	48 x 60	555	756
24 x 48	163	205	48 x 72	248	314	24 x 48	496	678	48 x 72	578	784
24 x 60	185	234	48 x 84	264	340	24 x 60	518	704	48 x 84	599	813
24 x 72	207	261	48 x 96	289	367	24 x 72	536	730	48 x 96	618	839
24 x 84	227	286	48 x 108	310	395	24 x 84	555	756	48 x 108	639	867
24 x 96	248	314	48 x 120	327	423	24 x 96	578	784	48 x 120	661	891
24 x 108	264	340	48 x 132	350	450	24 x 108	599	813	48 x 132	681	920
24 x 120	289	367	48 x 144	369	478	24 x 120	618	839	48 x 144	702	950

Kits Include:

- Mill finish or Dk. Bronze
- Cut to size and mitered bodies (**Slide Body** is pre-drilled and countersunk. **Bleed Body**, **Frameless Body** and **1/4 Round Body** are designed for welded assembly)
- All screws required to assemble by mechanical fastening
- All Corner Angles and/or Corner Keys required
- Packaging

Kits w/ Posts Include:

- Two (2) 95-5/8" posts
- Two (2) slightly oversized caps and screws with adjustable reveal for zero, 3/8" or 3/4" positions
- Cut-to-size reveal and "below the panel filler" (Below the panel filler is cut to fit 6" below grade)
- Add \$62.00 to kit price for ****Square/Round Posts**
- **For 12' Posts Add** - Mill Finish \$155.00, Dk. Bronze \$195.00 and Square/Round Posts \$201.00
- **Additional post length** - Mill Finish \$27.00, Dk. Bronze or Square/Round \$31.00 per linear foot
- Additional post options - See page 133

Not Included in Kits:

- Aluminum faces
- Internal Supports (Internal bracing may be required for panels over 30 square feet)

Kit Specifications:

- Custom size kits may be cut to any dimension

Additional Information (pgs 196-197)

*Dk. Bronze offering - Slide Body, Reveal, Radius and Rectangular Posts with caps and screws only.

Note: All dimensions are subject to the tolerance standards of the aluminum extrusion industry. Profile drawings are illustrative and rounded to the nearest 1/16".

CURRENT PRICE as of April 1, 2022



Unassembled Series 4 Kits - For Rigid Faces

4" Post & Panel Systems



Frameless Body
Part #1355
K1355

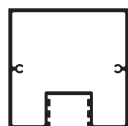
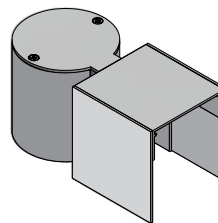

Part #1333



Part #1337



Part #1339



Part #1338

Without Posts

With Posts

Size H"xW"	Mill Finish	Size H"xW"	Mill Finish	Size H"xW"	Mill Finish	Size H"xW"	Mill Finish
12 x 12	\$88	30 x 30	\$151	12 x 12	\$456	30 x 30	\$522
12 x 24	107	30 x 36	162	12 x 24	476	30 x 36	534
12 x 36	129	30 x 48	185	12 x 36	499	30 x 48	559
12 x 48	151	30 x 60	203	12 x 48	522	30 x 60	578
12 x 60	171	30 x 72	226	12 x 60	547	30 x 72	602
12 x 72	195	30 x 84	248	12 x 72	569	30 x 84	625
12 x 84	217	30 x 96	270	12 x 84	591	30 x 96	646
12 x 96	238	30 x 108	293	12 x 96	631	30 x 108	670
		30 x 120	310			30 x 120	693
18 x 18	107			18 x 18	476		
18 x 24	122	36 x 36	171	18 x 24	490	36 x 36	547
18 x 30	129	36 x 48	195	18 x 30	499	36 x 48	569
18 x 36	139	36 x 60	217	18 x 36	514	36 x 60	591
18 x 48	162	36 x 72	238	18 x 48	534	36 x 72	613
18 x 60	185	36 x 84	259	18 x 60	559	36 x 84	637
18 x 72	203	36 x 96	278	18 x 72	578	36 x 96	661
18 x 84	226	36 x 108	304	18 x 84	602	36 x 108	681
18 x 96	248	36 x 120	327	18 x 96	625	36 x 120	702
		36 x 132	343			36 x 132	728
		36 x 144	367			36 x 144	749
24 x 24	129			24 x 24	499		
24 x 30	139			24 x 30	514		
24 x 36	151	48 x 48	217	24 x 36	522	48 x 48	591
24 x 48	171	48 x 60	238	24 x 48	547	48 x 60	613
24 x 60	195	48 x 72	259	24 x 60	569	48 x 72	637
24 x 72	217	48 x 84	278	24 x 72	591	48 x 84	661
24 x 84	238	48 x 96	304	24 x 84	613	48 x 96	681
24 x 96	259	48 x 108	327	24 x 96	637	48 x 108	702
24 x 108	278	48 x 120	343	24 x 108	661	48 x 120	728
24 x 120	304	48 x 132	367	24 x 120	681	48 x 132	749
		48 x 144	388			48 x 144	773

Kits Include:

- Mill finish
- Cut to size and mitered bodies (**Frameless Body** is designed for welded assembly)
- All Corner Angles and/or Corner Keys required
- Packaging

Kits w/ Posts Include:

- Two (2) 95-5/8" posts
- Two (2) slightly over sized caps with 3/4" reveal tab
- Cut-to-size reveal and "below the panel filler" (Below the panel filler is cut to fit 6" below grade)
- For 12' Posts Add - \$220.00
- Additional post length - \$34.00 per linear foot
- Additional post options - See page 133
- Call Customer Service for "4" Round 90 Degree Post and *4" Round 4-Sided Post pricing

Not Included in Kits:

- Aluminum faces
- Internal Supports (Internal bracing may be required for panels over 30 square feet)

Kit Specifications:

- Custom size kits may be cut to any dimension

Additional Information (pgs 196-197)

Unassembled Series 7 Kits - For Rigid Faces

3-1/2" Wall Mount Systems

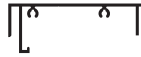

1/2 Slide Body
Part #1565
K1565

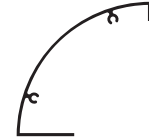

1/4 Round End (Optional)
Part #1670

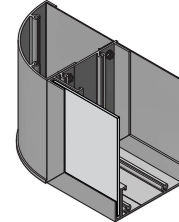
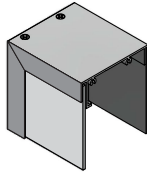

Without Ends

With Ends

Size H"xW"	Mill Finish	Size H"xW"	Mill Finish	Size H"xW"	Mill Finish	Size H"xW"	Mill Finish
12 x 24	\$173	30 x 30	\$207	12 x 24	\$210	30 x 30	\$280
12 x 36	190	30 x 36	214	12 x 36	227	30 x 36	285
12 x 48	207	30 x 48	231	12 x 48	242	30 x 48	304
12 x 60	225	30 x 60	249	12 x 60	259	30 x 60	317
12 x 72	239	30 x 72	264	12 x 72	280	30 x 72	336
12 x 84	258	30 x 84	282	12 x 84	292	30 x 84	350
12 x 96	273	30 x 96	296	12 x 96	312	30 x 96	368
		30 x 108	316			30 x 108	383
		30 x 120	334			30 x 120	400
18 x 18	173			18 x 18	223		
18 x 24	183			18 x 24	229		
18 x 30	190	36 x 36	225	18 x 30	236	36 x 36	306
18 x 36	201	36 x 48	239	18 x 36	248	36 x 48	321
18 x 48	214	36 x 60	258	18 x 48	261	36 x 60	338
18 x 60	231	36 x 72	273	18 x 60	281	36 x 72	355
18 x 72	249	36 x 84	290	18 x 72	293	36 x 84	369
18 x 84	264	36 x 96	308	18 x 84	314	36 x 96	387
18 x 96	282	36 x 108	322	18 x 96	327	36 x 108	403
		36 x 120	340			36 x 120	421
24 x 24	190	36 x 132	357	24 x 24	249	36 x 132	437
24 x 30	201	36 x 144	372	24 x 30	258	36 x 144	455
24 x 36	207			24 x 36	264		
24 x 48	225	48 x 48	258	24 x 48	282	48 x 48	360
24 x 60	239	48 x 60	273	24 x 60	296	48 x 60	378
24 x 72	258	48 x 72	290	24 x 72	316	48 x 72	393
24 x 84	273	48 x 84	308	24 x 84	334	48 x 84	412
24 x 96	290	48 x 96	322	24 x 96	348	48 x 96	425
24 x 108	308	48 x 108	340	24 x 108	367	48 x 108	444
24 x 120	322	48 x 120	357	24 x 120	381	48 x 120	459
		48 x 132	372			48 x 132	478
		48 x 144	392			48 x 144	494

Kits Include:

- Mill finish
- Cut to size and mitered bodies (1/2 Slide Body is pre-drilled and countersunk)
- All screws required to assemble by mechanical fastening
- All Corner Keys required
- Packaging

Kits w/ Ends Include:

- Two (2) 1/4 Round Ends
- Four (4) slightly over sized caps & screws
- 1/4 Round End attachment screws

Not Included in Kits:

- Aluminum face or back
- Internal Supports (Internal bracing may be required for panels over 30 square feet)

Kit Specifications:

- Custom size kits may be cut to any dimension
- 1/4 Round Ends cut .25" shorter than cabinet height

Additional Information (pgs 196-197)

Note: All dimensions are subject to the tolerance standards of the aluminum extrusion industry. Profile drawings are illustrative and rounded to the nearest 1/16".

CURRENT PRICE as of April 1, 2022



Unassembled Series 7 Kits - For Rigid Faces

7" Post & Panel Systems



Slide Body
Part #1560
K1560

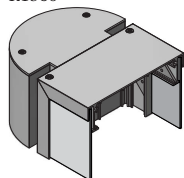

Bleed Body
Part #1570
K1570

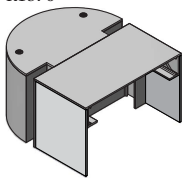

Frameless Body
Part #1575
K1575

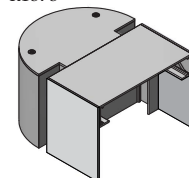

1/4 Round Body
Part #1580
K1580

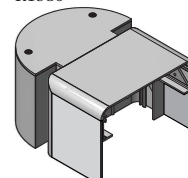

Part #1500

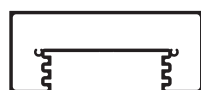

Part #1510

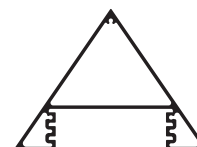

Part #1530

Without Posts

Size H"xW"	Mill Finish	Size H"xW"	Mill Finish
12 x 24	\$143	30 x 30	\$213
12 x 36	181	30 x 36	230
12 x 48	213	30 x 48	264
12 x 60	249	30 x 60	296
12 x 72	285	30 x 72	336
12 x 84	317	30 x 84	369
12 x 96	352	30 x 96	403
		30 x 108	439
		30 x 120	471
18 x 18	143		
18 x 24	162		
18 x 30	181	36 x 36	249
18 x 36	197	36 x 48	285
18 x 48	230	36 x 60	317
18 x 60	264	36 x 72	352
18 x 72	296	36 x 84	385
18 x 84	336	36 x 96	421
18 x 96	369	36 x 108	456
		36 x 120	488
		36 x 132	524
		36 x 144	559
24 x 24	181		
24 x 30	197		
24 x 36	213		
24 x 48	249	48 x 48	317
24 x 60	285	48 x 60	352
24 x 72	317	48 x 72	385
24 x 84	352	48 x 84	421
24 x 96	385	48 x 96	456
24 x 108	421	48 x 108	488
24 x 120	456	48 x 120	524
		48 x 132	559
		48 x 144	594

With Posts

Size H"xW"	Mill Finish	Size H"xW"	Mill Finish
12 x 24	881	30 x 30	\$950
12 x 36	916	30 x 36	969
12 x 48	950	30 x 48	1004
12 x 60	983	30 x 60	1037
12 x 72	1018	30 x 72	1071
12 x 84	1054	30 x 84	1105
12 x 96	1088	30 x 96	1141
		30 x 108	1174
		30 x 120	1209
18 x 18	881		
18 x 24	899		
18 x 30	916	36 x 36	983
18 x 36	931	36 x 48	1018
18 x 48	969	36 x 60	1054
18 x 60	1004	36 x 72	1088
18 x 72	1037	36 x 84	1120
18 x 84	1071	36 x 96	1160
18 x 96	1105	36 x 108	1192
		36 x 120	1227
		36 x 132	1264
		36 x 144	1296
24 x 24	916		
24 x 30	931		
24 x 36	950		
24 x 48	983	48 x 48	1054
24 x 60	1018	48 x 60	1088
24 x 72	1054	48 x 72	1120
24 x 84	1088	48 x 84	1160
24 x 96	1120	48 x 96	1192
24 x 108	1160	48 x 108	1227
24 x 120	1192	48 x 120	1264
		48 x 132	1296
		48 x 144	1330

Kits Include:

- Mill finish
- Cut to size and mitered bodies (**Slide Body** is pre-drilled and countersunk. **Bleed Body**, **Frameless Body** and **1/4 Round Body** are designed for welded assembly)
- All screws required to assemble by mechanical fastening
- All Corner Angles and/or Corner Keys required
- Packaging

Kits w/ Posts Include:

- Two (2) 95-5/8" posts
- Two (2) slightly oversized caps & screws with adjustable reveal for zero, 1/2" or 1" positions
- Cut-to-size reveal and "below the panel filler" (Below the panel filler is cut to fit 6" below grade)
- For 12' Posts Add - \$334.00
- Additional post length - \$55.00 per linear foot

Not Included in Kits:

- Aluminum faces
- Internal Supports (Internal bracing may be required for panels overs 30 square feet)

Kit Specifications:

- Custom size kits may be cut to any dimension

Additional Information (pgs 196-197)

ARCHITECTURAL

Unassembled Series 3 Access Body Kits - For Rigid Faces

3-1/4" Single/Double Face Non-Hingeable Bodies and Cover Options



Series 3 Single Face Access Body
Part #1291

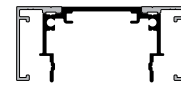

Series 3 Access Body
Part #1290

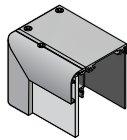

Slide
Part #1694
K1291/94
K1290/94



Radius Slide
Part #1695
K1291/95
K1290/95



Bleed
Part #1692
K1291/92
K1290/92



Frameless
Part #1693
K1291/93
K1290/93



*
Insert Top/Bottom
Part #1292
K1291/92/98
K1290/92/98

Single Face Kits

Double Face Kits

Size H"xW"	Mill Finish	Size H"xW"	Mill Finish	Size H"xW"	Mill Finish	Size H"xW"	Mill Finish
12 x 24	\$114	30 x 30	\$162	12 x 24	\$167	30 x 30	\$238
12 x 36	138	30 x 36	173	12 x 36	202	30 x 36	257
12 x 48	162	30 x 48	197	12 x 48	238	30 x 48	292
12 x 60	183	30 x 60	218	12 x 60	273	30 x 60	327
12 x 72	207	30 x 72	241	12 x 72	310	30 x 72	364
12 x 84	230	30 x 84	264	12 x 84	345	30 x 84	397
12 x 96	254	30 x 96	288	12 x 96	381	30 x 96	434
		30 x 108	310			30 x 108	468
		30 x 120	334			30 x 120	507
18 x 18	114			18 x 18	167		
18 x 24	126			18 x 24	185		
18 x 30	138	36 x 36	183	18 x 30	202	36 x 36	273
18 x 36	150	36 x 48	207	18 x 36	221	36 x 48	310
18 x 48	173	36 x 60	230	18 x 48	257	36 x 60	345
18 x 60	197	36 x 72	254	18 x 60	292	36 x 72	381
18 x 72	218	36 x 84	276	18 x 72	327	36 x 84	416
18 x 84	241	36 x 96	299	18 x 84	364	36 x 96	452
18 x 96	264	36 x 108	321	18 x 96	397	36 x 108	488
		36 x 120	345			36 x 120	522
24 x 24	138	36 x 132	368	24 x 24	202	36 x 132	559
24 x 30	150	36 x 144	392	24 x 30	221	36 x 144	594
24 x 36	162			24 x 36	238		
24 x 48	183	48 x 48	230	24 x 48	273	48 x 48	345
24 x 60	207	48 x 60	254	24 x 60	310	48 x 60	381
24 x 72	230	48 x 72	276	24 x 72	345	48 x 72	416
24 x 84	254	48 x 84	299	24 x 84	381	48 x 84	452
24 x 96	276	48 x 96	321	24 x 96	416	48 x 96	488
24 x 108	299	48 x 108	345	24 x 108	452	48 x 108	522
24 x 120	321	48 x 120	368	24 x 120	488	48 x 120	559
		48 x 132	392			48 x 132	594
		48 x 144	413			48 x 144	629

Kits Include:

- Mill finish
- Cut to size and mitered bodies
- Cut to size and mitered covers
- All screws required to assemble by mechanical fastening
- All Corner Angles and/or Corner Keys required
- Packaging

Not Included in Kits:

- Aluminum faces or back
- Divider(s) - See optional accessories
- Internal Supports (Internal bracing may be required for panels over 30 square feet)
- Post(s) - See optional accessories

Optional Accessories (pgs 133 & 150):

- Divider(s)
- Post(s) - (Series 3 Access Bodies are designed to integrate with the Series 2, Series 3 and Series 4 posts)

Kit Specifications:

- Custom size kits may be cut to any dimension

Divider Kits Include:

- Cut to size dividers
- Divider Tabs
- All screws required to assemble by mechanical fastening
- **1-1/4" Divider, Part #1662, \$5.81 per/ft per/face**
- For use with Slide and Radius Covers

Additional Information (pgs 196-197)

Note: All dimensions are subject to the tolerance standards of the aluminum extrusion industry. Profile drawings are illustrative and rounded to the nearest 1/16".

CURRENT PRICE as of April 1, 2022



Unassembled Series 4 Access Body Kits - For Rigid Faces

4" Single/Double Face Non-Hingeable Bodies and Cover Options

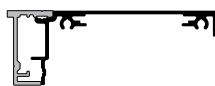

Series 4 Single Face Access Body
Part #1391

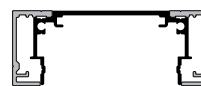

Series 4 Access Body
Part #1390

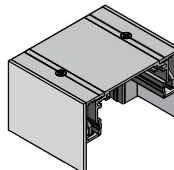
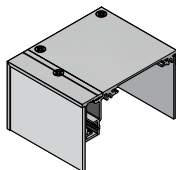

Slide
Part #1694
K1391/94
K1390/94

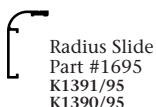

Radius Slide
Part #1695
K1391/95
K1390/95

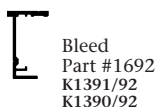

Bleed
Part #1692
K1391/92
K1390/92

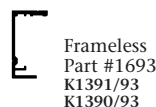

Frameless
Part #1693
K1391/93
K1390/93

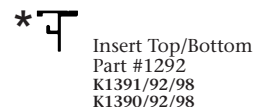

* Insert Top/Bottom
Part #1292
K1391/92/98
K1390/92/98

Single Face Kits

Double Face Kits

Size H"xW"	Mill Finish	Size H"xW"	Mill Finish	Size H"xW"	Mill Finish	Size H"xW"	Mill Finish
12 x 24	\$120	30 x 30	\$170	12 x 24	\$175	30 x 30	\$249
12 x 36	146	30 x 36	182	12 x 36	213	30 x 36	270
12 x 48	170	30 x 48	207	12 x 48	249	30 x 48	306
12 x 60	192	30 x 60	229	12 x 60	286	30 x 60	343
12 x 72	217	30 x 72	253	12 x 72	327	30 x 72	381
12 x 84	242	30 x 84	277	12 x 84	362	30 x 84	417
12 x 96	266	30 x 96	302	12 x 96	400	30 x 96	456
		30 x 108	327			30 x 108	491
		30 x 120	350	18 x 18	175	30 x 120	532
18 x 18	120			18 x 24	194		
18 x 24	132			18 x 30	213	36 x 36	286
18 x 30	146	36 x 36	192	18 x 36	233	36 x 48	327
18 x 36	157	36 x 48	217	18 x 48	270	36 x 60	362
18 x 48	182	36 x 60	242	18 x 60	306	36 x 72	400
18 x 60	207	36 x 72	266	18 x 72	343	36 x 84	437
18 x 72	229	36 x 84	289	18 x 84	381	36 x 96	474
18 x 84	253	36 x 96	314	18 x 96	417	36 x 108	514
18 x 96	277	36 x 108	337			36 x 120	548
		36 x 120	362	24 x 24	213	36 x 132	586
24 x 24	146	36 x 132	387	24 x 30	233	36 x 144	623
24 x 30	157	36 x 144	411	24 x 36	249		
24 x 36	170			24 x 48	286	48 x 48	362
24 x 48	192	48 x 48	242	24 x 60	327	48 x 60	400
24 x 60	217	48 x 60	266	24 x 72	362	48 x 72	437
24 x 72	242	48 x 72	289	24 x 84	400	48 x 84	474
24 x 84	266	48 x 84	314	24 x 96	437	48 x 96	514
24 x 96	289	48 x 96	337	24 x 108	474	48 x 108	548
24 x 108	314	48 x 108	362	24 x 120	514	48 x 120	586
24 x 120	337	48 x 120	387			48 x 132	623
		48 x 132	411			48 x 144	660
		48 x 144	434				

Kits Include:

- Mill finish
- Cut to size and mitered bodies
- Cut to size and mitered covers
- All screws required to assemble by mechanical fastening
- All Corner Angles and/or Corner Keys required
- Packaging

Not Included in Kits:

- Aluminum faces or back
- Divider(s) - See optional accessories
- Internal Supports (Internal bracing may be required for panels over 30 square feet)
- Post(s) - See optional accessories

Optional Accessories (pgs 133 & 150):

- Divider(s)
- Post(s) - (Series 4 Access Bodies are designed to integrate with the Series 2, Series 3 and Series 4 posts)

Kit Specifications:

- Custom size kits may be cut to any dimension

Divider Kits Include:

- Cut to size dividers
- Divider Tabs
- All screws required to assemble by mechanical fastening
- 1-1/4" Divider, Part #1662, \$5.81 per/ft per/face
- For use with Slide and Radius Covers

Additional Information (pgs 196-197)

*Call SignComp Customer Service for Insert Panel pricing

Unassembled Series 7/12 Retro Kits - For Rigid Faces

Series 7/12 Retro Body w/ Retainer Options

Part #1600

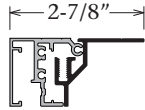

*** One Side Removable w/
Slide Retainer, Part #1624**
Access Frame, Part #1690
Slide Cover, Part #1694



Slide
Part #1624
K1600/24



3/4" Slide
Part #1626
K1600/26



Bleed
Part #1632
K1600/32



Frameless
Part #1631
K1600/31



1/4 Round
Part #1640
K1600/40

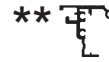

Insert
Part #1666
K1600/66/98

Size H"xW"	Mill Finish	Size H"xW"	Mill Finish	Size H"xW"	Mill Finish	Size H"xW"	Mill Finish
12 x 24	\$164	24 x 24	\$199	30 x 30	\$230	48 x 48	\$320
12 x 36	199	24 x 30	214	30 x 36	243	48 x 60	353
12 x 48	230	24 x 36	230	30 x 48	274	48 x 72	384
12 x 60	259	24 x 48	259	30 x 60	306	48 x 84	415
12 x 72	292	24 x 60	292	30 x 72	336	48 x 96	444
12 x 84	320	24 x 72	320	30 x 84	368	48 x 108	476
12 x 96	353	24 x 84	353	30 x 96	399	48 x 120	508
		24 x 96	384	30 x 108	432	48 x 132	539
18 x 18	164	24 x 108	415	30 x 120	462	48 x 144	570
18 x 24	181	24 x 120	444				
18 x 30	199			36 x 36	259		
18 x 36	214			36 x 48	292		
18 x 48	243			36 x 60	320		
18 x 60	274			36 x 72	353		
18 x 72	306			36 x 84	384		
18 x 84	336			36 x 96	415		
18 x 96	368			36 x 108	444		
				36 x 120	476		
				36 x 132	508		
				36 x 144	539		

Kits Include:

- Mill finish
- Cut to size and mitered bodies (**Hinge Body is designed for welded assembly**)
- Cut to size and mitered retainers (**Slide Retainers** are pre-drilled and countersunk. **Bleed Retainer, Frameless and 1/4 Round Retainers** are designed for welded assembly)
- **Slide Retainer** - One vertical side will be ***Access Frame (1690) and Slide Cover (1694)** to allow for sliding the rigid plastic face in and out
- **Access Frame** available on all sides with cover options: Slide (1694), Radius (1695), Frameless (1693) and Bleed (1692)
- All screws required to assemble by mechanical fastening
- All Corner Angles and/or Corner Keys required
- Packaging
- Prices reflect one (1) Retro Body kit, SINGLE FACE APPLICATION

Not Included in Kits:

- Face
- Electrical Components
- Divider(s) - See optional accessories
- Mounting Provisions

Optional Accessories (pg 150):

- Divider(s)

Kit Specifications:

- **Kits will be cut .305" larger to fit over existing structure**
- Custom size kits may be cut to any dimension
- Illumination may vary depending on application

Divider Kits Include:

- Cut to size dividers
- Divider Tabs
- All screws required to assemble by mechanical fastening
- **1-1/4" Divider, Part #1662, \$5.81 per/ft per/face**
- For use with Slide Retainer

Additional Information (pgs 196-197)

Note: All dimensions are subject to the tolerance standards of the aluminum extrusion industry. Profile drawings are illustrative and rounded to the nearest 1/16".

CURRENT PRICE as of April 1, 2022



Unassembled Series 7 Kits - For Rigid Faces

Series 7 Single Face Hinge Body w/ Retainer Options

Part #1602

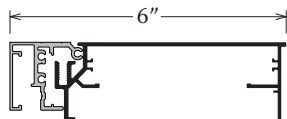

* One Side Removable w/ Slide Retainer, Part #1624
Access Frame, Part #1690
Slide Cover, Part #1694

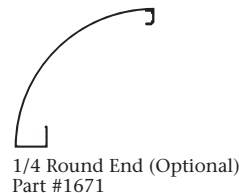

Slide
Part #1624
K1602/24



3/4" Slide
Part #1626
K1602/26



Bleed
Part #1632
K1602/32



Frameless
Part #1631
K1602/31



1/4 Round
Part #1640
K1602/40

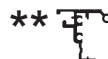

** Insert
Part #1666
K1602/66/98

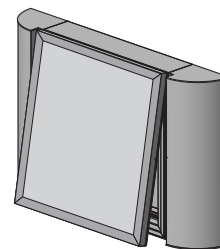

Without Ends

With Ends

Size H"xW"	Mill Finish	Price	Size H"xW"	Mill Finish	Price	Size H"xW"	Mill Finish	Price
12 x 24		\$209	30 x 30		\$304	12 x 24		\$296
12 x 36		257	30 x 36		322	12 x 36		345
12 x 48		304	30 x 48		368	12 x 48		392
12 x 60		346	30 x 60		415	12 x 60		434
12 x 72		393	30 x 72		459	12 x 72		483
12 x 84		437	30 x 84		507	12 x 84		524
12 x 96		484	30 x 96		551	12 x 96		574
			30 x 108		598			
			30 x 120		642			
18 x 18		209				18 x 18		316
18 x 24		231				18 x 24		340
18 x 30		257	36 x 36		346	18 x 30		362
18 x 36		280	36 x 48		393	18 x 36		383
18 x 48		322	36 x 60		437	18 x 48		431
18 x 60		368	36 x 72		484	18 x 60		474
18 x 72		415	36 x 84		528	18 x 72		520
18 x 84		459	36 x 96		575	18 x 84		566
18 x 96		507	36 x 108		618	18 x 96		611
			36 x 120		666			
			36 x 132		709	24 x 24		380
24 x 24		257	36 x 144		756	24 x 30		400
24 x 30		280				24 x 36		423
24 x 36		304	48 x 48		437	24 x 48		469
24 x 48		346	48 x 60		484	24 x 60		515
24 x 60		393	48 x 72		528	24 x 72		563
24 x 72		437	48 x 84		575	24 x 84		606
24 x 84		484	48 x 96		618	24 x 96		654
24 x 96		528	48 x 108		666	24 x 108		694
24 x 108		575	48 x 120		709	24 x 120		744
24 x 120		618	48 x 132		756			
			48 x 144		801			

Kits Include:

- Mill finish
- Cut to size and mitered bodies (**Hinge Body is designed for welded assembly**)
- Cut to size and mitered retainers (**Slide Retainers** are pre-drilled and countersunk. **Bleed Retainer, Frameless and 1/4 Round Retainers** are designed for welded assembly)
- **Slide Retainer** - One vertical side will be ***Access Frame (1690) and Slide Cover (1694)** to allow for sliding the rigid plastic face in and out
- **Access Frame** available on all sides with cover options: Slide (1694), Radius (1695), Frameless (1693) and Bleed (1692)
- All screws required to assemble by mechanical fastening
- All Corner Angles and/or Corner Keys required
- Packaging

Kits w/ Ends Include:

- Two (2) cut to size 1/4 Round Ends and mounting angles
- Four (4) oversized caps (**Weld only**)
- All screws required to assemble by mechanical fastening
- **Additional 1/4 Round Ends** - \$22.00 per/ft per/end

Not Included in Kits:

- Face or Back
- Electrical Components
- Ballast Bracket(s) - See optional accessories
- Back Braces and Gussets
- Raceway Covers and Cover Screws - See optional accessories
- Divider(s) - See optional accessories
- Mounting Provisions

Optional Accessories (pg 150):

- Ballast Bracket(s)
- Raceway Covers and Cover Screws
- Divider(s)

Kit Specifications:

- It is recommended to order kits 1/2" (horizontal) or 3/4" (vertical) over nominal T12 or T8 lamp size to utilize .040 flat Aluminum Raceway Covers
- Custom size kits may be cut to any dimension

Recommended Lamp Spacing:

- For illuminated backgrounds - 8"-9" on center, using T12 or T8 lamps
- Always place lamps 3/4" from back of sign

Divider Kits Include:

- Cut to size dividers
- Divider Tabs
- All screws required to assemble by mechanical fastening
- **1-1/4" Divider, Part #1662, \$5.81 per/ft per/face**
- For use with **Slide Retainer**

Additional Information (pgs 196-197)

Note: It is recommended to use safety chains and prop-bars on hingeable faces.

**Call SignComp Customer Service for Insert Panel pricing

Unassembled Series 7 Kits - For Rigid Faces

Series 7 Hinge Body w/ Retainer Options

Part #1592

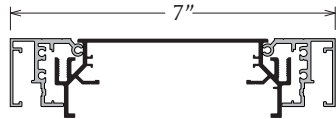

* **One Side Removable w/ Slide Retainer, Part #1624**
Access Frame, Part #1690
Slide Cover, Part #1694

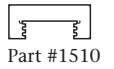
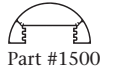
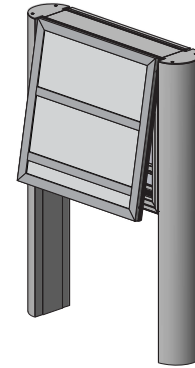

Slide
Part #1624
K1592/24



3/4" Slide
Part #1626
K1592/26



Bleed
Part #1632
K1592/32



Frameless
Part #1631
K1592/31



1/4 Round
Part #1640
K1592/40

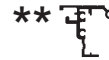

** Insert
Part #1666
K1592/66/98

Shown with optional Divider

Without Posts

With Posts

Size H"xW"	Mill Finish	Size H"xW"	Mill Finish	Size H"xW"	Mill Finish	Size H"xW"	Mill Finish
12 x 24	\$257	30 x 30	\$378	12 x 24	\$988	30 x 30	\$1113
12 x 36	317	30 x 36	409	12 x 36	1054	30 x 36	1144
12 x 48	378	30 x 48	469	12 x 48	1113	30 x 48	1208
12 x 60	439	30 x 60	530	12 x 60	1174	30 x 60	1267
12 x 72	499	30 x 72	592	12 x 72	1237	30 x 72	1328
12 x 84	563	30 x 84	654	12 x 84	1297	30 x 84	1390
12 x 96	623	30 x 96	716	12 x 96	1358	30 x 96	1450
		30 x 108	774			30 x 108	1509
		30 x 120	836			30 x 120	1574
18 x 18	257			18 x 18	988		
18 x 24	288			18 x 24	1021		
18 x 30	317	36 x 36	439	18 x 30	1054	36 x 36	1174
18 x 36	348	36 x 48	499	18 x 36	1085	36 x 48	1237
18 x 48	409	36 x 60	563	18 x 48	1144	36 x 60	1297
18 x 60	469	36 x 72	623	18 x 60	1208	36 x 72	1358
18 x 72	530	36 x 84	685	18 x 72	1267	36 x 84	1421
18 x 84	592	36 x 96	744	18 x 84	1328	36 x 96	1479
18 x 96	654	36 x 108	805	18 x 96	1390	36 x 108	1540
		36 x 120	865			36 x 120	1604
24 x 24	317	36 x 132	927	24 x 24	1054	36 x 132	1664
24 x 30	348	36 x 144	985	24 x 30	1085	36 x 144	1724
24 x 36	378			24 x 36	1113		
24 x 48	439	48 x 48	563	24 x 48	1174	48 x 48	1297
24 x 60	499	48 x 60	623	24 x 60	1237	48 x 60	1358
24 x 72	563	48 x 72	685	24 x 72	1297	48 x 72	1421
24 x 84	623	48 x 84	744	24 x 84	1358	48 x 84	1479
24 x 96	685	48 x 96	805	24 x 96	1421	48 x 96	1540
24 x 108	744	48 x 108	865	24 x 108	1479	48 x 108	1604
24 x 120	805	48 x 120	927	24 x 120	1540	48 x 120	1664
		48 x 132	1013			48 x 132	1751
		48 x 144	1073			48 x 144	1809

Kits Include:

- Mill finish
- Cut to size and mitered bodies (**Hinge Body is designed for welded assembly**)
- Cut to size and mitered retainers (**Slide Retainers** are pre-drilled and countersunk. **Bleed Retainer, Frameless and 1/4 Round Retainers** are designed for welded assembly)
- **Slide Retainer** - One vertical side will be ***Access Frame (1690) and Slide Cover (1694)** to allow for sliding the rigid plastic face in and out
- **Access Frame** available on all sides with cover options: Slide (1694), Radius (1695), Frameless (1693) and Bleed (1692)
- All screws required to assemble by mechanical fastening
- All Corner Angles and/or Corner Keys required
- Packaging

Kits w/ Posts Include:

- Two (2) 95-5/8" posts
- Two (2) slightly oversized caps and screws with adjustable reveal for zero, 1/2" or 1" positions
- Cut-to-size reveal and "below the panel filler" (Below the panel filler is cut to fit 6" below grade)
- **For 12' Posts** - \$334.00
- **Additional post length** - \$55.00 per linear foot

Not Included in Kits:

- Faces
- Electrical Components
- Ballast Bracket(s) - See optional accessories
- Internal Supports
- Raceway Covers and Cover Screws - See optional accessories
- Divider(s) - See optional accessories
- Mounting Provisions

Optional Accessories (pg 150):

- Ballast Bracket(s)
- Raceways Covers and Cover Screws
- Divider(s)

Kit Specifications:

- **Not designed for full face illumination applications with flat plastic faces**
- Custom size kits may be cut to any dimension

Divider Kits Include:

- Cut to size dividers
- Divider Tabs
- All screws required to assemble by mechanical fastening
- **1-1/4" Divider, Part #1662, \$5.81 per/ft per face**
- For use with **Slide Retainer**

Additional Information (pgs 196-197)

Note: All dimensions are subject to the tolerance standards of the aluminum extrusion industry. Profile drawings are illustrative and rounded to the nearest 1/16".

CURRENT PRICE as of April 1, 2022



Unassembled Series 12 Kits - For Rigid Faces

Series 12 Hinge Body w/ Retainer Options

Part #1612

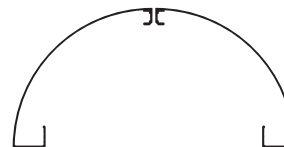
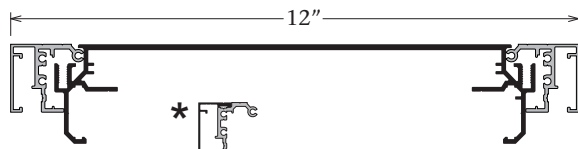

1/4 Round End (Optional)
Part #1671

One Side Removable w/ Slide Retainer, Part #1624
Access Frame, Part #1690
Slide Cover, Part #1694



Slide
Part #1624
K1612/24



3/4" Slide
Part #1626
K1612/26



Bleed
Part #1632
K1612/32



Frameless
Part #1631
K1612/31



1/4 Round
Part #1640
K1612/40



Insert
Part #1666
K1612/66/98

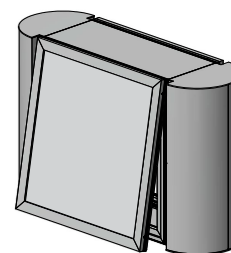

Without Ends

With Ends

Size H"xW"	Mill Finish	Size H"xW"	Mill Finish	Size H"xW"	Mill Finish	Size H"xW"	Mill Finish
24 x 24	\$381	36 x 36	\$539	24 x 24	\$574	36 x 36	\$797
24 x 36	459	36 x 48	618	24 x 36	653	36 x 48	876
24 x 48	539	36 x 60	697	24 x 48	729	36 x 60	954
24 x 60	618	36 x 72	777	24 x 60	811	36 x 72	1037
24 x 72	697	36 x 84	856	24 x 72	888	36 x 84	1116
24 x 84	777	36 x 96	935	24 x 84	969	36 x 96	1195
24 x 96	856	36 x 108	1014	24 x 96	1046	36 x 108	1272
24 x 108	935	36 x 120	1094	24 x 108	1129	36 x 120	1351
24 x 120	1014	36 x 132	1173	24 x 120	1208	36 x 132	1432
24 x 132	1094	36 x 144	1253	24 x 132	1290	36 x 144	1513
24 x 144	1173			24 x 144	1364		
		48 x 48	697			48 x 48	1025
30 x 30	457	48 x 60	777	30 x 30	685	48 x 60	1105
30 x 36	496	48 x 72	856	30 x 36	774	48 x 72	1181
30 x 48	579	48 x 84	935	30 x 48	805	48 x 84	1264
30 x 60	658	48 x 96	1014	30 x 60	884	48 x 96	1343
30 x 72	738	48 x 108	1094	30 x 72	963	48 x 108	1422
30 x 84	816	48 x 120	1173	30 x 84	1042	48 x 120	1500
30 x 96	896	48 x 132	1253	30 x 96	1121	48 x 132	1578
30 x 108	976	48 x 144	1331	30 x 108	1201	48 x 144	1660
30 x 120	1055			30 x 120	1279		
30 x 132	1133	60 x 60	856	30 x 132	1362	60 x 60	1248
30 x 144	1213	60 x 72	935	30 x 144	1439	60 x 72	1330
		60 x 84	1014			60 x 84	1406
		60 x 96	1094			60 x 96	1488
		60 x 108	1173			60 x 108	1565
		60 x 120	1253			60 x 120	1647
		60 x 132	1331			60 x 132	1725
		60 x 144	1413			60 x 144	1806

Kits Include:

- Mill finish
- Cut to size and mitered bodies (**Hinge Body is designed for welded assembly**)
- Cut to size and mitered retainers (**Slide Retainers** are pre-drilled and countersunk. **Bleed Retainer, Frameless and 1/4 Round Retainers** are designed for welded assembly)
- **Slide Retainer** - One vertical side will be ***Access Frame (1690) and Slide Cover (1694)** to allow for sliding the rigid plastic face in and out
- **Access Frame** available on all sides with cover options: Slide (1694), Radius (1695), Frameless (1693) and Bleed (1692)
- All screws required to assemble by mechanical fastening
- All Corner Angles and/or Corner Keys required
- Packaging

Kits w/ Ends Include:

- Four (4) cut to size 1/4 Round Ends and mounting angles
- Two (2) oversized caps with 1-1/4" Reveal Tab (**Weld only**)
- All screws required to assemble by mechanical fastening
- **Additional 1/2 Round Ends** - \$41.00 per/ft per/end

Not Included in Kits:

- Faces
- Electrical Components
- Ballast Bracket(s) - See optional accessories
- Internal Supports
- Raceway Covers and Cover Screws - See optional accessories
- Divider(s) - See optional accessories
- Mounting Provisions

Optional Accessories (pg 150):

- Ballast Bracket(s)
- Raceway Covers and Cover Screws
- Divider(s)

Kit Specifications:

- **It is recommended to order kits 1/2" (horizontal) or 3/4" (vertical) over nominal T12 or T8 lamp size to utilize .040 flat Aluminum Raceway Covers**
- Custom size kits may be cut to any dimension

Recommended Lamp Spacing:

- For illuminated backgrounds - 10" on center, using T12 or T8 lamps

Divider Kits Include:

- Cut to size dividers
- Divider Tabs
- All screws required to assemble by mechanical fastening
- **1-1/4" Divider, Part #1662, \$5.81 per/ft per face**
- For use with **Slide Retainer**

Additional Information (pgs 196-197)

Note: It is recommended to use safety chains and prop-bars on hingeable faces.

**Call SignComp Customer Service for Insert Panel pricing

Unassembled Series 7/12 Retro Kits - For Rigid Faces

Series 7/12 Retro Body w/ Additional Retainer Options

Part #1600

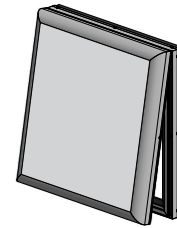
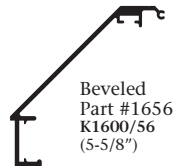
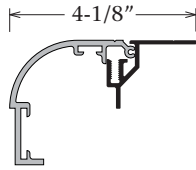

Size H"xW"	Mill Finish	Size H"xW"	Mill Finish	Size H"xW"	Mill Finish	Size H"xW"	Mill Finish
12 x 24	\$192	24 x 24	\$238	30 x 30	\$278	48 x 48	\$396
12 x 36	238	24 x 30	258	30 x 36	296	48 x 60	439
12 x 48	278	24 x 36	278	30 x 48	336	48 x 72	480
12 x 60	317	24 x 48	317	30 x 60	378	48 x 84	520
12 x 72	360	24 x 60	360	30 x 72	416	48 x 96	560
12 x 84	396	24 x 72	396	30 x 84	460	48 x 108	601
12 x 96	439	24 x 84	439	30 x 96	500	48 x 120	642
		24 x 96	480	30 x 108	542	48 x 132	682
		24 x 108	520	30 x 120	581	48 x 144	724
		24 x 120	560				
18 x 18	192			36 x 36	317		
18 x 24	214			36 x 48	360		
18 x 30	238			36 x 60	396		
18 x 36	258			36 x 72	439		
18 x 48	296			36 x 84	480		
18 x 60	336			36 x 96	520		
18 x 72	378			36 x 108	560		
18 x 84	416			36 x 120	601		
18 x 96	460			36 x 132	642		
				36 x 144	682		

Kits Include:

- Mill finish
- Cut to size and mitered bodies (**Hinge Body is designed for welded assembly**)
- Cut to size and mitered retainers (**Extended 1/4 Round and Beveled Retainers are designed for welded assembly**)
- All screws required to assemble by mechanical fastening
- All Corner Angles and/or Corner Keys required
- Packaging
- Prices reflect one (1) Retro Body kit, SINGLE FACE APPLICATION

Kit Specifications:

- Kits will be cut .305" larger to fit over existing structure
- Custom size kits may be cut to any dimension
- Illumination may vary depending on application

Additional Information (pgs 196-197)

Not Included in Kits:

- Face
- Electrical Components
- Mounting Provisions

Note: It is recommended to use safety chains and prop-bars on hingeable faces.

Note: All dimensions are subject to the tolerance standards of the aluminum extrusion industry. Profile drawings are illustrative and rounded to the nearest 1/16".

CURRENT PRICE as of April 1, 2022



Unassembled Series 7 Kits - For Rigid Faces

Series 7 Single Face Hinge Body w/ Additional Retainer Options

Part #1602

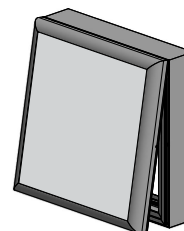
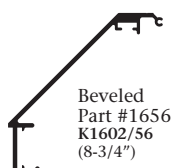
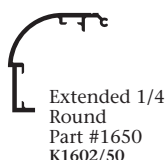
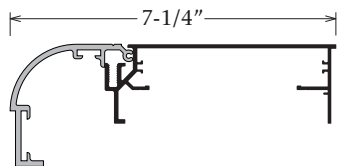

Size H"xW"	Mill Finish	Size H"xW"	Mill Finish	Size H"xW"	Mill Finish	Size H"xW"	Mill Finish
12 x 24	\$236	24 x 24	\$294	30 x 30	\$352	48 x 48	\$514
12 x 36	294	24 x 30	322	30 x 36	377	48 x 60	569
12 x 48	352	24 x 36	352	30 x 48	431	48 x 72	625
12 x 60	404	24 x 48	404	30 x 60	487	48 x 84	681
12 x 72	460	24 x 60	460	30 x 72	539	48 x 96	733
12 x 84	514	24 x 72	514	30 x 84	598	48 x 108	789
12 x 96	569	24 x 84	569	30 x 96	653	48 x 120	844
18 x 18	236	24 x 96	625	30 x 108	708	48 x 132	900
18 x 24	265	24 x 108	681	30 x 120	761	48 x 144	956
18 x 30	294	24 x 120	733				
18 x 36	322			36 x 36	404		
18 x 48	377			36 x 48	460		
18 x 60	431			36 x 60	514		
18 x 72	487			36 x 72	569		
18 x 84	539			36 x 84	625		
18 x 96	598			36 x 96	681		
				36 x 108	733		
				36 x 120	789		
				36 x 132	844		
				36 x 144	900		

Kits Include:

- Mill finish
- Cut to size and mitered bodies (**Hinge Body is designed for welded assembly**)
- Cut to size and mitered retainers (**Extended 1/4 Round and Beveled Retainers** are designed for welded assembly)
- All screws required to assemble by mechanical fastening
- All Corner Angles and/or Corner Keys required
- Packaging

Not Included in Kits:

- Face or Back
- Electrical Components
- Ballast Bracket(s) - See optional accessories
- Back Braces and Gussets
- Raceway Covers and Cover Screws - See optional accessories
- Mounting Provisions

Optional Accessories (pg 150):

- Ballast Bracket(s)
- Raceway Covers and Cover Screws

Kit Specifications:

- It is recommended to order kits 1/2" (horizontal) or 3/4" (vertical) over nominal T12 or T8 lamp size to utilize .040 flat Aluminum Raceway Covers
- Custom size kits may be cut to any dimension

Recommended Lamp Spacing:

- For illuminated backgrounds - 8"- 9" on center, using T12 or T8 lamps
- Always place lamps 3/4" from back of sign

Additional Information (pgs 196-197)

Note: It is recommended to use safety chains and prop-bars on hingeable faces.

Unassembled Series 7 Kits - For Rigid Faces

Series 7 Hinge Body w/ Additional Retainer Options

Part #1592

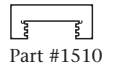
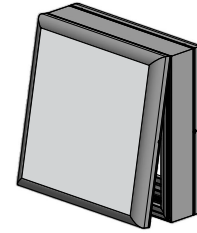
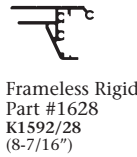
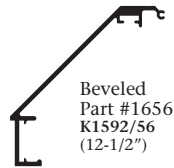
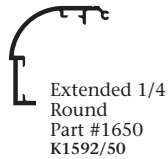
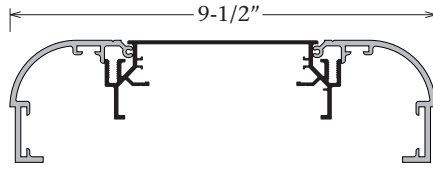

Without Posts

With Posts

Size H"xW"	Mill Finish	Size H"xW"	Mill Finish	Size H"xW"	Mill Finish	Size H"xW"	Mill Finish
12 x 24	\$314	30 x 30	\$474	12 x 24	\$1045	30 x 30	\$1209
12 x 36	393	30 x 36	515	12 x 36	1130	30 x 36	1249
12 x 48	474	30 x 48	594	12 x 48	1209	30 x 48	1331
12 x 60	552	30 x 60	673	12 x 60	1290	30 x 60	1409
12 x 72	631	30 x 72	755	12 x 72	1371	30 x 72	1493
12 x 84	717	30 x 84	836	12 x 84	1451	30 x 84	1572
12 x 96	796	30 x 96	915	12 x 96	1530	30 x 96	1651
		30 x 108	994			30 x 108	1730
		30 x 120	1076			30 x 120	1814
18 x 18	314			18 x 18	1045		
18 x 24	355			18 x 24	1088		
18 x 30	393	36 x 36	552	18 x 30	1130	36 x 36	1290
18 x 36	434	36 x 48	631	18 x 36	1170	36 x 48	1371
18 x 48	515	36 x 60	717	18 x 48	1249	36 x 60	1451
18 x 60	594	36 x 72	796	18 x 60	1331	36 x 72	1530
18 x 72	673	36 x 84	876	18 x 72	1409	36 x 84	1611
18 x 84	755	36 x 96	954	18 x 84	1493	36 x 96	1691
18 x 96	836	36 x 108	1035	18 x 96	1572	36 x 108	1770
		36 x 120	1114			36 x 120	1853
24 x 24	393	36 x 132	1193	24 x 24	1130	36 x 132	1932
24 x 30	434	36 x 144	1272	24 x 30	1170	36 x 144	2012
24 x 36	474			24 x 36	1209		
24 x 48	552	48 x 48	717	24 x 48	1290	48 x 48	1451
24 x 60	631	48 x 60	796	24 x 60	1371	48 x 60	1530
24 x 72	717	48 x 72	876	24 x 72	1451	48 x 72	1611
24 x 84	796	48 x 84	954	24 x 84	1530	48 x 84	1691
24 x 96	876	48 x 96	1035	24 x 96	1611	48 x 96	1770
24 x 108	954	48 x 108	1114	24 x 108	1691	48 x 108	1853
24 x 120	1035	48 x 120	1193	24 x 120	1770	48 x 120	1932
		48 x 132	1300			48 x 132	2037
		48 x 144	1379			48 x 144	2115

Kits Include:

- Mill finish
- Cut to size and mitered bodies (**Hinge Body is designed for welded assembly**)
- Cut to size and mitered retainers (**Extended 1/4 Round and Beveled Retainers are designed for welded assembly**)
- All screws required to assemble by mechanical fastening
- All Corner Angles and/or Corner Keys required
- Packaging

Kits w/ Posts Include:

- Two (2) 95-5/8" posts
- Two (2) slightly oversized caps and screws with adjustable reveal for zero, 1/2" or 1" positions
- Cut-to-size reveal and "below the panel filler" (Below the panel filler is cut to fit 6" below grade)
- For 12' Posts - \$334.00
- Additional post length - \$55.00 per linear foot

Not Included in Kits:

- Faces
- Electrical Components
- Ballast Bracket(s) - See optional accessories
- Internal Supports
- Raceway Covers and Cover Screws - See optional accessories
- Mounting Provisions

Optional Accessories (pg 150):

- Ballast Bracket(s)
- Raceway Covers and Cover Screws

Kit Specifications:

- Custom size kits may be cut to any dimension

Additional Information (pgs 196-197)

Note: It is recommended to use safety chains and prop-bars on hingeable faces.

Note: All dimensions are subject to the tolerance standards of the aluminum extrusion industry. Profile drawings are illustrative and rounded to the nearest 1/16".

CURRENT PRICE as of April 1, 2022



Unassembled Series 12 Kits - For Rigid Faces

Series 12 Hinge Body w/ Additional Retainer Options

Part #1612

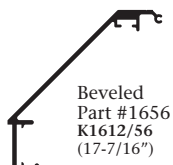
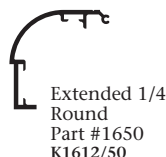
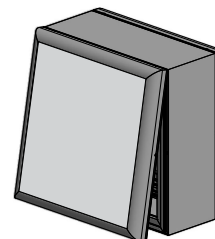
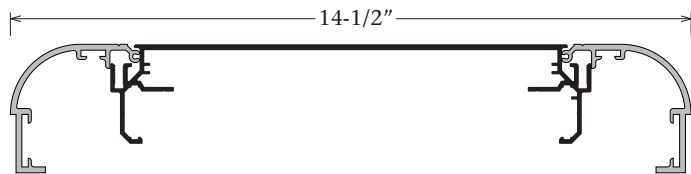

Size H"xW"	Mill Finish	Size H"xW"	Mill Finish	Size H"xW"	Mill Finish	Size H"xW"	Mill Finish
24 x 24	\$457	30 x 30	\$552	48 x 48	\$851	60 x 60	\$1046
24 x 36	554	30 x 36	602	48 x 60	950	60 x 72	1146
24 x 48	654	30 x 48	704	48 x 72	1046	60 x 84	1244
24 x 60	752	30 x 60	801	48 x 84	1146	60 x 96	1343
24 x 72	851	30 x 72	902	48 x 96	1244	60 x 108	1441
24 x 84	950	30 x 84	998	48 x 108	1343	60 x 120	1542
24 x 96	1046	30 x 96	1095	48 x 120	1441	60 x 132	1637
24 x 108	1146	30 x 108	1196	48 x 132	1542	60 x 144	1737
24 x 120	1244	30 x 120	1295	48 x 144	1637		
24 x 132	1343	30 x 132	1391				
24 x 144	1441	30 x 144	1493				
		36 x 36	654				
		36 x 48	752				
		36 x 60	851				
		36 x 72	950				
		36 x 84	1046				
		36 x 96	1146				
		36 x 108	1244				
		36 x 120	1343				
		36 x 132	1441				
		36 x 144	1542				

Kits Include:

- Mill finish
- Cut to size and mitered bodies (**Hinge Body is designed for welded assembly**)
- Cut to size and mitered retainers (**Extended 1/4 Round or Beveled Retainers** are designed for welded assembly)
- All screws required to assemble by mechanical fastening
- All Corner Angles and/or Corner Keys required
- Packaging

Not Included in Kits:

- Faces
- Electrical Components
- Ballast Bracket(s) - See optional accessories
- Internal Supports
- Raceway Covers and Cover Screws - See optional accessories
- Mounting Provisions

Optional Accessories (pg 150):

- Ballast Bracket(s)
- Raceway Covers and Cover Screws

Kit Specifications:

- It is recommended to order kits 1/2" (horizontal) or 3/4" (vertical) over nominal T12 or T8 lamp size to utilize .040 flat Aluminum Raceway Covers
- Custom size kits may be cut to any dimension



Recommended Lamp Spacing:

- For illuminated backgrounds - 10" on center, using T12 or T8 lamps

Additional Information (pgs 196-197)

Note: It is recommended to use safety chains and prop-bars on hingeable faces.

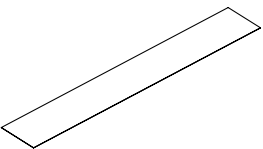
Architectural System Optional Accessories

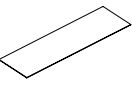
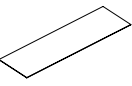
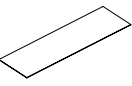
Divider	Part	Part Number	Cost Per/Ft Mill Finish
<h3 style="color: #A52A2A;">Cut To Size Divider</h3> <p>For Rigid Plastic Faces</p>			
	<p>1-1/4" Divider Included:</p> <ul style="list-style-type: none"> • Screws for mechanical fastening • Divider Angles 	K1662	\$5.81
<h3 style="color: #A52A2A;">Accessories</h3>			
<h4 style="color: #A52A2A;">Raceway Covers (Blank)</h4>			
	<p>Series 12 Hinge Body Raceway Cover 9-1/8" x 48" x .040" (white) Blank</p>	5124	\$25.21
	<p>Series 7 Hinge Body / Series 7 Single Face Hinge Body Raceway Cover 4-3/8" x 48" x .040" (white) Blank</p>	5122	10.09
<h4 style="color: #A52A2A;">Ballast Pans</h4>			
	<p>Series 12 Hinge Body Ballast Bracket 8-11/16" x 24" x .080"</p>	5107	12.63
	<p>Series 7 Hinge Body Ballast Bracket 3-3/4" x 24" x .080"</p>	5102	12.63
	<p>Series 7 Single Face Hinge Body Ballast Bracket 4-1/8" x 24" x .080"</p>	5104	12.63

Note: All dimensions are subject to the tolerance standards of the aluminum extrusion industry. Profile drawings are illustrative and rounded to the nearest 1/16".

CURRENT PRICE as of April 1, 2022



RTS Post & Panel Systems

3-1/4" Round Post

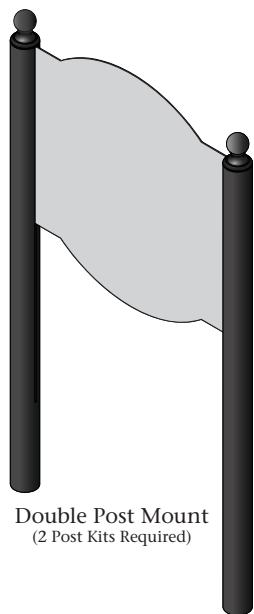

Double Post Mount
(2 Post Kits Required)

Flagmount

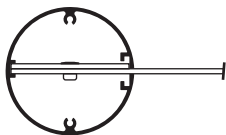

Double Post Mount

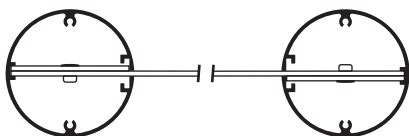

3-1/4" Square Post

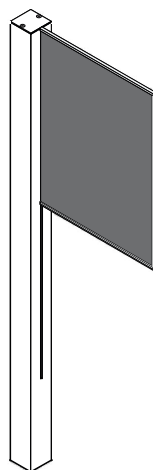

Flagmount

Flagmount

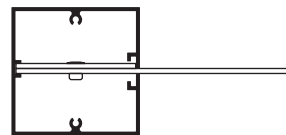

Double Post Mount

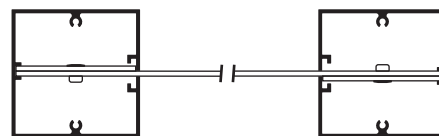

Round Post

Price per Post Kit

94" Post

Part #RTS-1017-8' WHT
Part #RTS-1017-8' BLK
\$166.89 each

144" Post

Part #RTS-1017-12' WHT
Part #RTS-1017-12' BLK
\$239.20 each

Available in powder coated gloss white and gloss black finishes.

Optional Accessories

High Density Polyurethane Finials

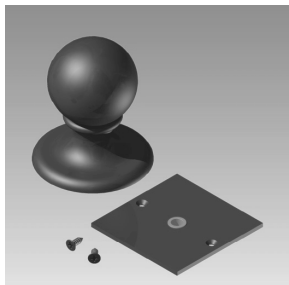

Ball Finial Kit w/Square Cap
White - Part #RTS-5700F WHT
Black - Part #RTS-5700F BLK
\$58.81 each

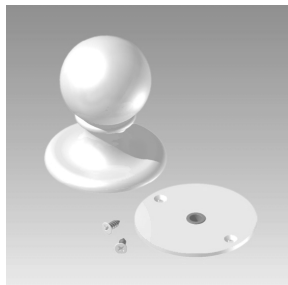

Ball Finial Kit w/Round Cap
White - Part #RTS-5701F WHT
Black - Part #RTS-5701F BLK
\$58.81 each

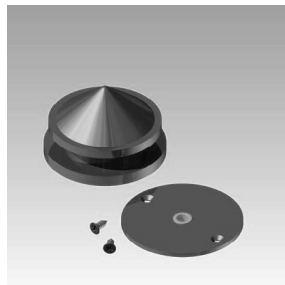

Tapered Ring Finial Kit w/Round Cap
White - Part #RTS-5703F WHT
Black - Part #RTS-5703F BLK
\$58.81 each

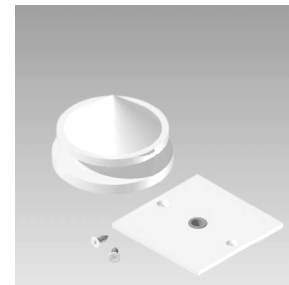

Tapered Ring Finial Kit w/Square Cap
White - Part #RTS-5702F WHT
Black - Part #RTS-5702F BLK
\$58.81 each

RTS Post Kit includes:

- 48" slot to accommodate up to a 48" high, 1/8" or 3mm panel
 - One (1) adjustable, 48" Post Filler to accommodate a panel less than 48" high
 - One (1) 1/8" Post Cap with two (2) countersunk cap screws
 - One (1) adjustable 94" Panel Trim for 1/8" or 3mm hollow core panel material
 - Two (2) 6" Locking Strips
 - One (1) 94" or 144" powder coated gloss white or gloss black RTS Post
- Note: Face material not included

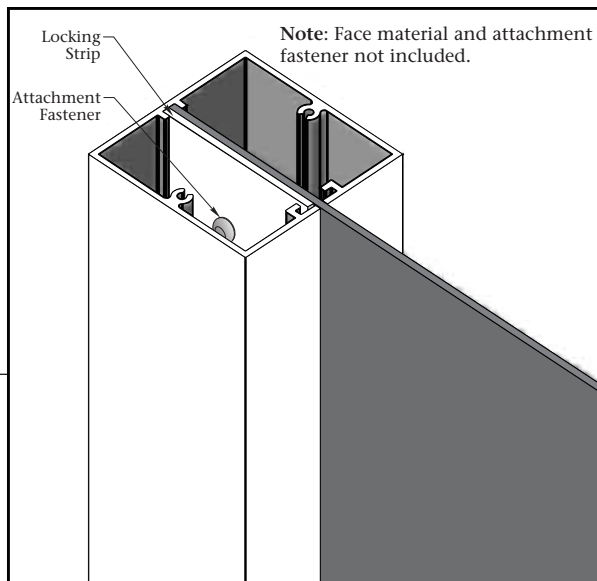

Note: Face material and attachment fastener not included.

Square Post

Price per Post Kit

94" Post

Part #RTS-1015-8' WHT
Part #RTS-1015-8' BLK
\$181.72 each

144" Post

Part #RTS-1015-12' WHT
Part #RTS-1015-12' BLK
\$261.45 each

Available in powder coated gloss white and gloss black finishes.

Finial Kits Include:

- Finial with 1/4" threaded stud
 - Cap with 1/4" threaded insert
 - Two (2) Cap Screws
- Note: Caps are slightly oversized

Standard Kits

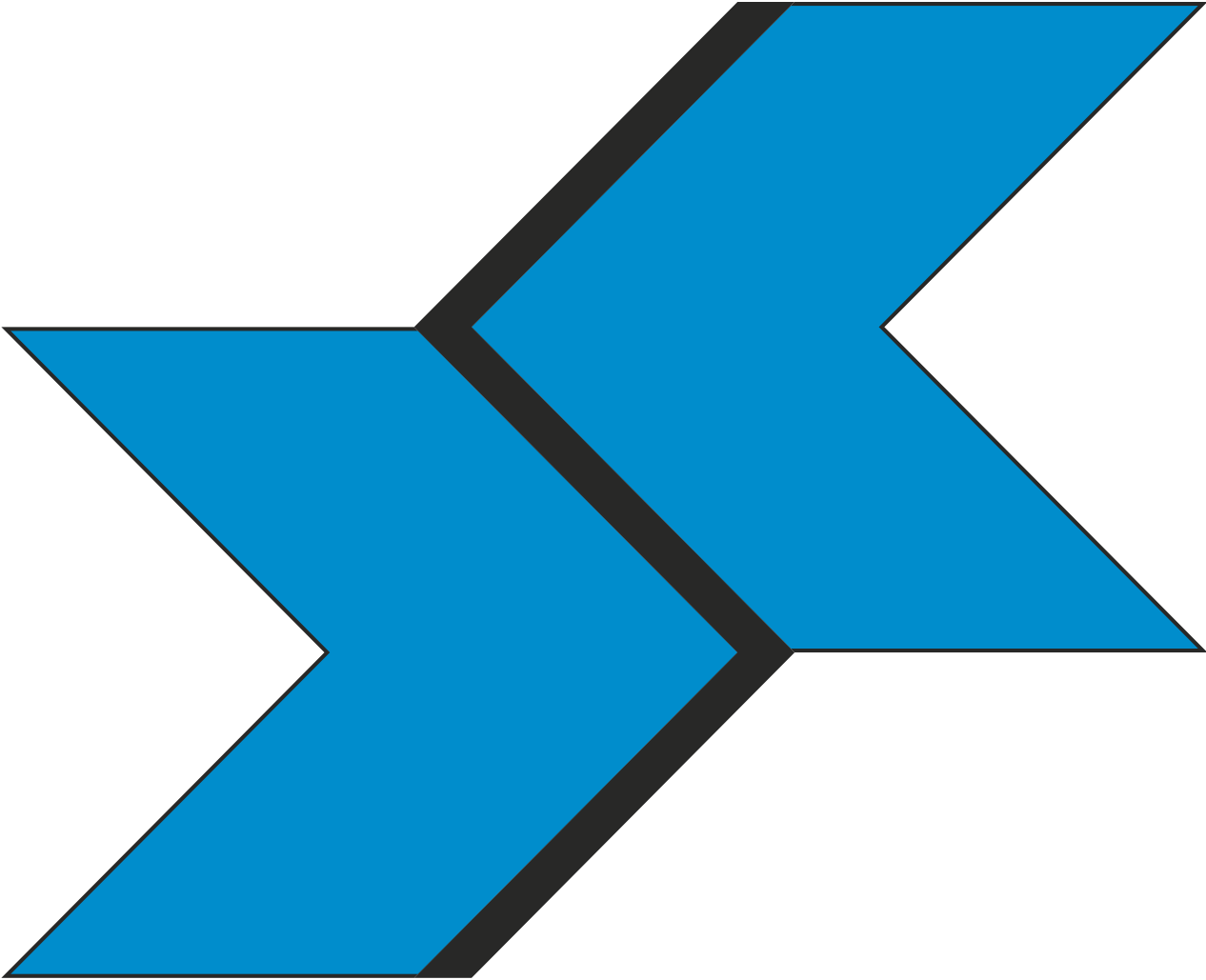

Unassembled Single Face Kits - For Rigid Faces

1Part 6" S/F Body and 2Part 6" S/F Body w/ 2Part Retainer

Part #1921
K1921/26/44

Part #1926

Part #1944

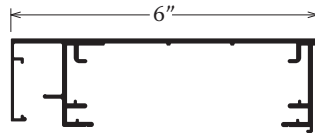

1Part Body



2 Part Body

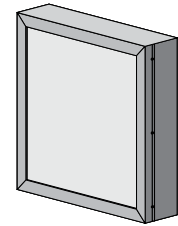

Size H'xW'	Mill Finish	Dk. Bronze	Size H'xW'	Mill Finish	Dk. Bronze	Size H'xW'	Mill Finish	Dk. Bronze	Size H'xW'	Mill Finish	Dk. Bronze
2 x 3	\$198	\$257	4 x 4	\$288	\$373	6 x 6	\$412	\$535	8 x 14	\$740	\$962
2 x 4	230	299	4 x 5	321	416	6 x 7	445	579	8 x 15	773	1004
2 x 5	264	345	4 x 6	355	462	6 x 8	479	623	8 x 16	808	1050
2 x 6	301	387	4 x 7	388	506	6 x 9	514	667	8 x 17	843	1094
2 x 7	333	432	4 x 8	424	550	6 x 10	548	710	8 x 18	875	1137
2 x 8	367	475	4 x 9	456	594	6 x 11	581	756	8 x 19	911	1181
2 x 9	399	520	4 x 10	491	638	6 x 12	615	799	8 x 20	943	1225
2 x 10	434	564	4 x 11	523	682	6 x 13	648	844	9 x 9	598	778
2 x 11	469	609	4 x 12	559	728	6 x 14	683	887	9 x 10	633	821
2 x 12	502	653	4 x 13	594	769	6 x 15	718	932	9 x 11	666	867
2 x 13	536	697	4 x 14	626	815	6 x 16	750	975	9 x 12	701	911
2 x 14	570	740	4 x 15	661	857	6 x 17	785	1021	9 x 13	733	954
2 x 15	602	785	4 x 16	693	903	6 x 18	817	1065	9 x 14	768	998
2 x 16	639	828	4 x 17	729	946	6 x 19	853	1109	9 x 15	801	1042
2 x 17	671	874	4 x 18	762	991	6 x 20	887	1152	9 x 16	836	1086
2 x 18	705	916	4 x 19	796	1035	7 x 7	474	615	9 x 17	869	1132
2 x 19	740	962	4 x 20	829	1079	7 x 8	508	661	9 x 18	903	1174
2 x 20	774	1004				7 x 9	541	704	9 x 19	936	1220
			5 x 5	349	455	7 x 10	576	749	9 x 20	972	1263
3 x 3	226	292	5 x 6	384	499	7 x 11	609	792	10 x 10	661	859
3 x 4	259	337	5 x 7	416	542	7 x 12	643	837	10 x 11	694	903
3 x 5	292	381	5 x 8	452	586	7 x 13	677	881	10 x 12	729	946
3 x 6	327	425	5 x 9	487	631	7 x 14	710	924	10 x 13	762	991
3 x 7	362	469	5 x 10	519	674	7 x 15	745	969	10 x 14	796	1035
3 x 8	395	514	5 x 11	554	720	7 x 16	780	1013	10 x 15	829	1079
3 x 9	429	557	5 x 12	586	762	7 x 17	812	1057	10 x 16	865	1122
3 x 10	462	602	5 x 13	622	808	7 x 18	847	1102	10 x 17	897	1167
3 x 11	495	645	5 x 14	655	851	7 x 19	881	1145	10 x 18	932	1211
3 x 12	532	690	5 x 15	689	896	7 x 20	915	1190	10 x 19	964	1256
3 x 13	564	733	5 x 16	722	939	8 x 8	536	697	10 x 20	999	1299
3 x 14	598	778	5 x 17	756	983	8 x 9	570	740			
3 x 15	631	821	5 x 18	790	1027	8 x 10	603	785			
3 x 16	667	867	5 x 19	825	1071	8 x 11	638	828			
3 x 17	701	911	5 x 20	857	1116	8 x 12	671	874			
3 x 18	733	954				8 x 13	705	916			
3 x 19	768	998									
3 x 20	801	1042									

Kits Include:

- Mill Finish or Dk. Bronze
- Cut to size and mitered bodies
- Cut to size and mitered retainers
- One vertical side will be 2Part Body (1926) with 2Part Retainer (1944) to allow for sliding the rigid plastic face in and out
- All screws required to assemble by mechanical fastening
- All Corner Angles and/or Corner Keys required
- Packaging

Not Included in Kits:

- Face or Back
- Electrical Components
- Ballast Pan(s) - See optional accessories
- Back Braces and Gussets
- Raceway Covers and Cover Screws - See optional accessories
- Divider(s) - See optional accessories
- Mounting Provisions

Optional Accessories (pgs 182-183):

- Ballast Pan(s)
- Raceway Covers and Cover Screws
- Divider(s)

Kit Specifications:

- It is recommended to order kits 1-3/4" over nominal T12 or T8 lamp size to utilize .040 flat Aluminum Raceway Covers
- Custom size kits may be cut to any dimension

Recommended Lamp Spacing:

- For illuminated backgrounds - 6" on center, using T12 or T8 lamps
- Always place lamps 3/4" from back of sign

Divider Kits Include:

- Cut to size dividers
- Divider Corner Angles
- All screws required to assemble by mechanical fastening
- 2Part Divider, Part #1905, Mill Finish \$5.94 and Dk. Bronze \$7.71 per/ft per/face

Additional Information (pgs 196-197)

Note: All dimensions are subject to the tolerance standards of the aluminum extrusion industry. Profile drawings are illustrative and rounded to the nearest 1/16".

CURRENT PRICE as of April 1, 2022



Unassembled Single Face Kits - For Rigid Faces

1Part 8" S/F Body and 2Part 8" S/F Body w/ 2Part Retainer

Part #1922
K1922/27/44

Part #1927

Part #1944

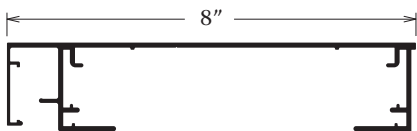

1Part Body



2 Part Body

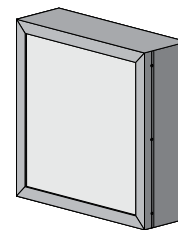

Size H'xW'	Mill Finish	Dk. Bronze	Size H'xW'	Mill Finish	Dk. Bronze	Size H'xW'	Mill Finish	Dk. Bronze	Size H'xW'	Mill Finish	Dk. Bronze
2 x 3	\$234	\$305	4 x 4	\$345	\$417	6 x 6	\$494	\$642	8 x 14	\$887	\$1153
2 x 4	276	357	4 x 5	384	499	6 x 7	535	694	8 x 15	927	1207
2 x 5	316	411	4 x 6	425	551	6 x 8	575	748	8 x 16	969	1259
2 x 6	356	463	4 x 7	464	606	6 x 9	615	801	8 x 17	1009	1311
2 x 7	396	516	4 x 8	508	657	6 x 10	655	853	8 x 18	1046	1363
2 x 8	437	567	4 x 9	547	710	6 x 11	697	904	8 x 19	1089	1416
2 x 9	478	622	4 x 10	586	761	6 x 12	738	958	8 x 20	1130	1469
2 x 10	518	673	4 x 11	627	816	6 x 13	777	1010			
2 x 11	559	725	4 x 12	667	869	6 x 14	817	1065	9 x 9	720	934
2 x 12	598	778	4 x 13	709	920	6 x 15	857	1116	9 x 10	758	987
2 x 13	641	832	4 x 14	749	975	6 x 16	900	1170	9 x 11	800	1039
2 x 14	681	884	4 x 15	788	1026	6 x 17	939	1220	9 x 12	840	1094
2 x 15	720	935	4 x 16	829	1079	6 x 18	979	1272	9 x 13	881	1145
2 x 16	760	988	4 x 17	871	1132	6 x 19	1019	1327	9 x 14	922	1197
2 x 17	801	1041	4 x 18	912	1184	6 x 20	1061	1378	9 x 15	960	1249
2 x 18	843	1095	4 x 19	951	1237				9 x 16	1003	1302
2 x 19	883	1146	4 x 20	990	1290	7 x 7	569	742	9 x 17	1042	1356
2 x 20	923	1201				7 x 8	610	792	9 x 18	1083	1407
			5 x 5	419	546	7 x 9	651	844	9 x 19	1122	1462
3 x 3	269	350	5 x 6	460	597	7 x 10	690	899	9 x 20	1164	1513
3 x 4	310	403	5 x 7	499	651	7 x 11	730	950			
3 x 5	350	456	5 x 8	541	702	7 x 12	773	1004	10 x 10	795	1034
3 x 6	392	508	5 x 9	581	755	7 x 13	811	1055	10 x 11	835	1085
3 x 7	431	560	5 x 10	622	808	7 x 14	853	1109	10 x 12	875	1136
3 x 8	471	613	5 x 11	662	859	7 x 15	891	1161	10 x 13	915	1189
3 x 9	514	666	5 x 12	702	914	7 x 16	934	1212	10 x 14	956	1241
3 x 10	551	718	5 x 13	744	964	7 x 17	975	1267	10 x 15	998	1296
3 x 11	594	773	5 x 14	783	1018	7 x 18	1013	1318	10 x 16	1037	1347
3 x 12	631	824	5 x 15	824	1070	7 x 19	1055	1372	10 x 17	1077	1402
3 x 13	674	875	5 x 16	865	1122	7 x 20	1095	1423	10 x 18	1117	1453
3 x 14	716	928	5 x 17	904	1176				10 x 19	1160	1505
3 x 15	753	981	5 x 18	947	1228	8 x 8	643	837	10 x 20	1199	1558
3 x 16	796	1035	5 x 19	985	1280	8 x 9	685	888			
3 x 17	836	1086	5 x 20	1026	1332	8 x 10	724	943			
3 x 18	876	1141				8 x 11	765	995			
3 x 19	916	1192				8 x 12	807	1046			
3 x 20	956	1244				8 x 13	845	1100			

Kits Include:

- Mill Finish or Dk. Bronze
- Cut to size and mitered bodies
- Cut to size and mitered retainers
- One vertical side will be 2Part Body (1927) with 2Part Retainer (1944) to allow for sliding the rigid plastic face in and out
- All screws required to assemble by mechanical fastening
- All Corner Angles and/or Corner Keys required
- Packaging

Not Included in Kits:

- Face or Back
- Electrical Components
- Ballast Pan(s) - See optional accessories
- Back Braces and Gussets
- Raceway Covers and Cover Screws - See optional accessories
- Divider(s) - See optional accessories
- Mounting Provisions

Optional Accessories (pgs 182-183):

- Ballast Pan(s)
- Raceway Covers and Cover Screws
- Divider(s)

Kit Specifications:

- It is recommended to order kits 1-3/4" over nominal T12 or T8 lamp size to utilize .040 flat Aluminum Raceway Covers
- Custom size kits may be cut to any dimension

Recommended Lamp Spacing:

- For illuminated backgrounds - 10" on center, using T12 or T8 lamps
- Always place lamps 3/4" from back of sign

Divider Kits Include:

- Cut to size dividers
- Divider Corner Angles
- All screws required to assemble by mechanical fastening
- 2Part Divider, Part #1905, Mill Finish \$5.94 and Dk. Bronze \$7.71 per/ft per/face

Additional Information (pgs 196-197)

STANDARD

Unassembled Double Face Kits - For Rigid Faces

1Part 6" D/F Body and 2Part 6" D/F Body w/ 2Part 6" D/F Retainer

Part #1931
K1931/36/54

Part #1936

Part #1954

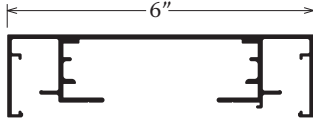

1Part Body



2 Part Body

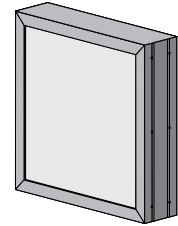

Size H'xW'	Mill Finish	Dk. Bronze	Size H'xW'	Mill Finish	Dk. Bronze	Size H'xW'	Mill Finish	Dk. Bronze	Size H'xW'	Mill Finish	Dk. Bronze
2 x 3	\$210	\$276	4 x 4	\$318	\$415	6 x 6	\$463	\$601	8 x 14	\$823	\$1067
2 x 4	249	320	4 x 5	355	462	6 x 7	496	649	8 x 15	857	1114
2 x 5	282	367	4 x 6	392	510	6 x 8	535	694	8 x 16	891	1161
2 x 6	318	413	4 x 7	428	552	6 x 9	571	744	8 x 17	928	1208
2 x 7	355	460	4 x 8	462	599	6 x 10	606	788	8 x 18	964	1253
2 x 8	392	508	4 x 9	496	646	6 x 11	642	835	8 x 19	1003	1300
2 x 9	425	552	4 x 10	535	693	6 x 12	678	881	8 x 20	1037	1347
2 x 10	462	599	4 x 11	569	742	6 x 13	716	927			
2 x 11	496	646	4 x 12	606	785	6 x 14	749	975	9 x 9	678	883
2 x 12	532	693	4 x 13	642	835	6 x 15	784	1019	9 x 10	716	928
2 x 13	569	742	4 x 14	678	881	6 x 16	823	1067	9 x 11	750	976
2 x 14	606	785	4 x 15	714	927	6 x 17	856	1114	9 x 12	784	1021
2 x 15	642	835	4 x 16	749	975	6 x 18	891	1161	9 x 13	823	1069
2 x 16	676	881	4 x 17	784	1019	6 x 19	928	1208	9 x 14	857	1116
2 x 17	714	927	4 x 18	820	1067	6 x 20	964	1253	9 x 15	895	1161
2 x 18	749	975	4 x 19	856	1114				9 x 16	928	1208
2 x 19	783	1019	4 x 20	891	1161	7 x 7	535	694	9 x 17	964	1253
2 x 20	820	1066				7 x 8	571	744	9 x 18	1003	1300
			5 x 5	392	510	7 x 9	607	788	9 x 19	1037	1347
3 x 3	249	321	5 x 6	428	554	7 x 10	642	836	9 x 20	1071	1394
3 x 4	285	368	5 x 7	462	601	7 x 11	678	883			
3 x 5	318	415	5 x 8	496	649	7 x 12	716	927	10 x 10	750	976
3 x 6	355	460	5 x 9	535	693	7 x 13	749	975	10 x 11	784	1021
3 x 7	392	508	5 x 10	571	742	7 x 14	784	1019	10 x 12	823	1069
3 x 8	425	552	5 x 11	606	785	7 x 15	823	1067	10 x 13	857	1116
3 x 9	462	599	5 x 12	642	835	7 x 16	857	1114	10 x 14	895	1162
3 x 10	496	646	5 x 13	678	881	7 x 17	891	1161	10 x 15	928	1209
3 x 11	535	693	5 x 14	714	927	7 x 18	928	1208	10 x 16	964	1257
3 x 12	569	742	5 x 15	749	975	7 x 19	964	1253	10 x 17	1003	1300
3 x 13	606	785	5 x 16	784	1019	7 x 20	1002	1300	10 x 18	1038	1347
3 x 14	642	835	5 x 17	823	1067				10 x 19	1071	1394
3 x 15	676	881	5 x 18	856	1114	8 x 8	607	788	10 x 20	1109	1441
3 x 16	714	927	5 x 19	891	1161	8 x 9	642	836			
3 x 17	749	975	5 x 20	928	1208	8 x 10	678	883			
3 x 18	784	1019				8 x 11	716	928			
3 x 19	820	1067				8 x 12	750	976			
3 x 20	856	1114				8 x 13	784	1021			

Kits Include:

- Mill Finish or Dk. Bronze
- Cut to size and mitered bodies
- Cut to size and mitered retainers
- One vertical side will be 2Part Body (1936) with 2Part Retainer (1954) to allow for sliding the rigid plastic face in and out
- All screws required to assemble by mechanical fastening
- All Corner Angles and/or Corner Keys required
- Packaging

Not Included in Kits:

- Faces
- Electrical Components
- Internal Supports
- Divider(s) - See optional accessories

Optional Accessories (pg 182):

- Divider(s)

Kit Specifications:

- It is recommended to order kits 1" over nominal T12 or T8 lamp size to utilize .040 flat Aluminum Raceway Covers
- Custom size kits may be cut to any dimension

Recommended Lamp Spacing:

- For illuminated backgrounds - 5" on center, using T12 or T8 lamps

Divider Kits Include:

- Cut to size dividers
- Divider Corner Angles
- All screws required to assemble by mechanical fastening
- 2Part Divider, Part #1905, Mill Finish \$5.94 and Dk. Bronze \$7.71 per/ft per/face

Additional Information (pgs 196-197)

Note: All dimensions are subject to the tolerance standards of the aluminum extrusion industry. Profile drawings are illustrative and rounded to the nearest 1/16".

CURRENT PRICE as of April 1, 2022



Unassembled Double Face Kits - For Rigid Faces

1Part 9" D/F Body and 2Part 9" D/F Body w/ 2Part Retainer

Part #1923
K1923/28/44

Part #1928

Part #1944

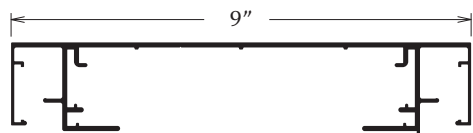

1Part Body



2Part Body

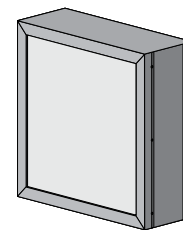

Size H'xW'	Mill Finish	Dk. Bronze	Size H'xW'	Mill Finish	Dk. Bronze	Size H'xW'	Mill Finish	Dk. Bronze	Size H'xW'	Mill Finish	Dk. Bronze
2 x 3	\$262	\$343	4 x 4	\$392	\$510	6 x 6	\$564	\$730	8 x 14	\$995	\$1293
2 x 4	306	399	4 x 5	434	566	6 x 7	607	788	8 x 15	1038	1348
2 x 5	350	456	4 x 6	478	622	6 x 8	351	844	8 x 16	1082	1406
2 x 6	393	514	4 x 7	522	678	6 x 9	693	902	8 x 17	1122	1462
2 x 7	435	567	4 x 8	566	736	6 x 10	738	956	8 x 18	1168	1520
2 x 8	483	625	4 x 9	610	789	6 x 11	780	1013	8 x 19	1211	1574
2 x 9	523	681	4 x 10	653	847	6 x 12	824	1070	8 x 20	1253	1632
2 x 10	567	738	4 x 11	694	903	6 x 13	867	1128			
2 x 11	611	792	4 x 12	740	959	6 x 14	911	1183	9 x 9	820	1067
2 x 12	654	849	4 x 13	781	1014	6 x 15	953	1239	9 x 10	862	1121
2 x 13	697	906	4 x 14	825	1071	6 x 16	998	1296	9 x 11	906	1180
2 x 14	742	960	4 x 15	869	1129	6 x 17	1039	1350	9 x 12	950	1236
2 x 15	783	1018	4 x 16	912	1184	6 x 18	1083	1407	9 x 13	991	1293
2 x 16	827	1073	4 x 17	954	1241	6 x 19	1128	1465	9 x 14	1037	1347
2 x 17	871	1132	4 x 18	999	1297	6 x 20	1170	1522	9 x 15	1082	1404
2 x 18	914	1186	4 x 19	1041	1355				9 x 16	1122	1461
2 x 19	956	1243	4 x 20	1085	1409	7 x 7	649	844	9 x 17	1168	1518
2 x 20	1002	1299				7 x 8	692	900	9 x 18	1211	1574
			5 x 5	478	622	7 x 9	736	956	9 x 19	1253	1630
3 x 3	306	397	5 x 6	520	676	7 x 10	778	1011	9 x 20	1297	1687
3 x 4	350	455	5 x 7	564	732	7 x 11	823	1069			
3 x 5	393	511	5 x 8	607	788	7 x 12	865	1122	10 x 10	906	1177
3 x 6	435	567	5 x 9	651	845	7 x 13	908	1181	10 x 11	950	1236
3 x 7	480	623	5 x 10	693	903	7 x 14	951	1239	10 x 12	991	1291
3 x 8	522	681	5 x 11	738	958	7 x 15	995	1295	10 x 13	1037	1347
3 x 9	566	736	5 x 12	780	1014	7 x 16	1039	1350	10 x 14	1079	1403
3 x 10	610	792	5 x 13	824	1070	7 x 17	1083	1406	10 x 15	1121	1461
3 x 11	653	847	5 x 14	867	1129	7 x 18	1128	1465	10 x 16	1165	1516
3 x 12	694	904	5 x 15	911	1183	7 x 19	1170	1520	10 x 17	1209	1573
3 x 13	740	959	5 x 16	953	1240	7 x 20	1212	1576	10 x 18	1251	1627
3 x 14	781	1015	5 x 17	999	1296				10 x 19	1296	1684
3 x 15	825	1073	5 x 18	1041	1351	8 x 8	736	954	10 x 20	1339	1740
3 x 16	869	1130	5 x 19	1085	1409	8 x 9	778	1011			
3 x 17	912	1186	5 x 20	1129	1466	8 x 10	823	1067			
3 x 18	954	1241				8 x 11	865	1122			
3 x 19	1002	1299				8 x 12	908	1180			
3 x 20	1042	1355				8 x 13	951	1237			

Kits Include:

- Mill Finish or Dk. Bronze
- Cut to size and mitered bodies
- Cut to size and mitered retainers
- One vertical side will be 2Part Body (1928) with 2Part Retainer (1944) to allow for sliding the rigid plastic face in and out
- All screws required to assemble by mechanical fastening
- All Corner Angles and/or Corner Keys required
- Packaging

Not Included in Kits:

- Faces
- Electrical Components
- Ballast Pan(s) - See optional accessories
- Internal Supports
- Raceway Covers and Cover Screws - See optional accessories
- Divider(s) - See optional accessories

Optional Accessories: (pgs 182-183)

- Ballast Pan(s)
- Raceway Covers and Cover Screws
- Divider(s)

Kit Specifications:

- It is recommended to order kits 1-3/4" over nominal T12 or T8 lamp size to utilize .040 flat Aluminum Raceway Covers
- Custom size kits may be cut to any dimension

Recommended Lamp Spacing:

- For illuminated backgrounds - 7" on center, using T12 or T8 lamps

Divider Kits Include:

- Cut to size dividers
- Divider Corner Angles
- All screws required to assemble by mechanical fastening
- 2Part Divider, Part #1905, Mill Finish \$5.94 and Dk. Bronze \$7.71 per/ft per/face

Additional Information (pgs 196-197)

Unassembled Double Face Kits - For Rigid Faces

1Part 12" D/F Body and 2Part 12" D/F Body w/ 2Part Retainer

Part #1924
K1924/29/44

Part #1929

Part #1944

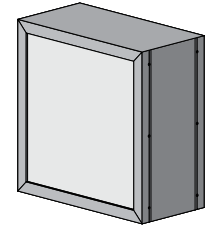
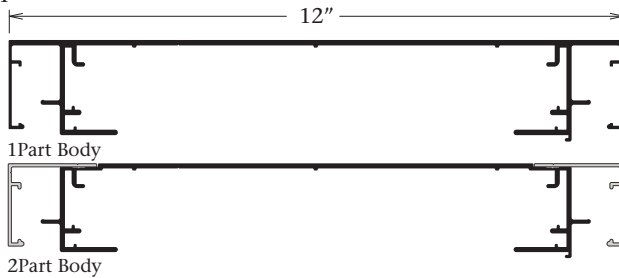

Size H'xW'	Mill Finish	Dk. Bronze	Size H'xW'	Mill Finish	Dk. Bronze	Size H'xW'	Mill Finish	Dk. Bronze	Size H'xW'	Mill Finish	Dk. Bronze
2 x 3	\$306	\$397	4 x 4	\$456	\$592	6 x 6	\$655	\$852	8 x 14	\$1154	\$1500
2 x 4	356	463	4 x 5	507	657	6 x 7	704	916	8 x 15	1205	1564
2 x 5	406	528	4 x 6	554	723	6 x 8	753	981	8 x 16	1253	1630
2 x 6	457	594	4 x 7	605	786	6 x 9	805	1045	8 x 17	1303	1695
2 x 7	509	658	4 x 8	655	853	6 x 10	855	1111	8 x 18	1354	1759
2 x 8	556	723	4 x 9	705	916	6 x 11	904	1176	8 x 19	1404	1824
2 x 9	607	787	4 x 10	755	982	6 x 12	954	1242	8 x 20	1453	1891
2 x 10	657	853	4 x 11	806	1045	6 x 13	1006	1305	9 x 9	953	1240
2 x 11	705	918	4 x 12	856	1113	6 x 14	1055	1372	9 x 10	1004	1303
2 x 12	755	984	4 x 13	906	1177	6 x 15	1105	1435	9 x 11	1054	1371
2 x 13	806	1047	4 x 14	954	1242	6 x 16	1155	1501	9 x 12	1104	1434
2 x 14	856	1114	4 x 15	1006	1306	6 x 17	1205	1564	9 x 13	1154	1500
2 x 15	906	1177	4 x 16	1055	1372	6 x 18	1253	1632	9 x 14	1205	1563
2 x 16	956	1243	4 x 17	1105	1438	6 x 19	1303	1698	9 x 15	1253	1630
2 x 17	1007	1306	4 x 18	1155	1501	6 x 20	1354	1761	9 x 16	1302	1695
2 x 18	1057	1374	4 x 19	1206	1566	7 x 7	753	981	9 x 17	1352	1759
2 x 19	1107	1438	4 x 20	1258	1633	7 x 8	805	1044	9 x 18	1403	1824
2 x 20	1157	1503				7 x 9	855	1111	9 x 19	1453	1890
			5 x 5	554	721	7 x 10	904	1176	9 x 20	1503	1954
3 x 3	356	463	5 x 6	605	786	7 x 11	954	1240	10 x 10	1054	1368
3 x 4	406	526	5 x 7	655	852	7 x 12	1006	1305	10 x 11	1104	1434
3 x 5	457	594	5 x 8	705	916	7 x 13	1054	1371	10 x 12	1154	1500
3 x 6	509	657	5 x 9	755	982	7 x 14	1104	1435	10 x 13	1202	1563
3 x 7	554	723	5 x 10	805	1045	7 x 15	1154	1500	10 x 14	1250	1630
3 x 8	605	786	5 x 11	855	1113	7 x 16	1205	1564	10 x 15	1302	1693
3 x 9	655	853	5 x 12	904	1176	7 x 17	1253	1632	10 x 16	1352	1759
3 x 10	705	918	5 x 13	954	1242	7 x 18	1303	1695	10 x 17	1403	1822
3 x 11	755	982	5 x 14	1006	1305	7 x 19	1354	1761	10 x 18	1453	1890
3 x 12	806	1047	5 x 15	1055	1372	7 x 20	1404	1824	10 x 19	1503	1954
3 x 13	856	1113	5 x 16	1105	1438	8 x 8	855	1111	10 x 20	1554	2019
3 x 14	906	1177	5 x 17	1155	1501	8 x 9	904	1174			
3 x 15	956	1242	5 x 18	1206	1566	8 x 10	953	1240			
3 x 16	1007	1306	5 x 19	1258	1632	8 x 11	1004	1303			
3 x 17	1055	1374	5 x 20	1303	1698	8 x 12	1054	1371			
3 x 18	1105	1438				8 x 13	1104	1435			
3 x 19	1155	1503									
3 x 20	1206	1566									

Kits Include:

- Mill Finish or Dk. Bronze
- Cut to size and mitered bodies
- Cut to size and mitered retainers
- One vertical side will be 2Part Body (1929) with 2Part Retainer (1944) to allow for sliding the rigid plastic face in and out
- All screws required to assemble by mechanical fastening
- All Corner Angles and/or Corner Keys required
- Packaging

Not Included in Kits:

- Faces
- Electrical Components
- Ballast Pan(s) - See optional accessories
- Internal Supports
- Raceway Covers and Cover Screws - See optional accessories
- Divider(s) - See optional accessories

Optional Accessories (pgs 182-183):

- Ballast Pan(s)
- Raceway Covers and Cover Screws
- Divider(s)

Kit Specifications:

- It is recommended to order kits 1-3/4" over nominal T12 or T8 lamp size to utilize .040 flat Aluminum Raceway Covers
- Custom size kits may be cut to any dimension

Recommended Lamp Spacing:

- For illuminated backgrounds - 9" on center, using T12 or T8 lamps

Divider Kits Include:

- Cut to size dividers
- Divider Corner Angles
- All screws required to assemble by mechanical fastening
- 2Part Divider, Part #1905, Mill Finish \$5.94 and Dk. Bronze \$7.71 per/ft per/face

Additional Information (pgs 196-197)

Note: All dimensions are subject to the tolerance standards of the aluminum extrusion industry. Profile drawings are illustrative and rounded to the nearest 1/16".

CURRENT PRICE as of April 1, 2022



Unassembled Retro Kits - For Rigid Faces

2Part Extended Retainer

Part #1940
K1940

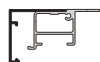
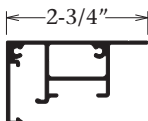

One Side Removable w/
2Part Extended Frame, Part #1955
2Part Retainer, Part #1944

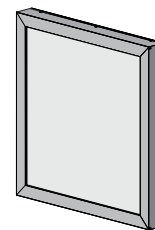

Size H'xW'	Mill Finish	Dk. Bronze	Size H'xW'	Mill Finish	Dk. Bronze	Size H'xW'	Mill Finish	Dk. Bronze	Size H'xW'	Mill Finish	Dk. Bronze
2 x 3	\$163	\$210	4 x 4	\$227	\$296	6 x 6	\$316	\$409	8 x 14	\$534	\$693
2 x 4	182	238	4 x 5	249	324	6 x 7	337	437	8 x 15	555	721
2 x 5	203	266	4 x 6	273	352	6 x 8	360	464	8 x 16	578	748
2 x 6	227	294	4 x 7	292	381	6 x 9	378	494	8 x 17	598	777
2 x 7	249	322	4 x 8	316	409	6 x 10	403	522	8 x 18	622	808
2 x 8	273	350	4 x 9	337	437	6 x 11	425	550	8 x 19	642	836
2 x 9	292	380	4 x 10	360	464	6 x 12	447	579	8 x 20	666	863
2 x 10	314	408	4 x 11	378	494	6 x 13	468	606			
2 x 11	336	435	4 x 12	401	522	6 x 14	488	635	9 x 9	447	581
2 x 12	356	463	4 x 13	424	550	6 x 15	511	662	9 x 10	469	607
2 x 13	378	492	4 x 14	444	579	6 x 16	531	692	9 x 11	490	637
2 x 14	401	520	4 x 15	468	606	6 x 17	555	720	9 x 12	514	664
2 x 15	424	548	4 x 16	488	635	6 x 18	578	746	9 x 13	534	693
2 x 16	444	578	4 x 17	511	662	6 x 19	598	776	9 x 14	555	721
2 x 17	467	606	4 x 18	531	692	6 x 20	622	805	9 x 15	578	748
2 x 18	487	635	4 x 19	554	720				9 x 16	598	777
2 x 19	511	662	4 x 20	575	746	7 x 7	360	468	9 x 17	623	808
2 x 20	531	692				7 x 8	380	495	9 x 18	642	836
			5 x 5	273	352	7 x 9	403	523	9 x 19	666	863
3 x 3	182	239	5 x 6	293	381	7 x 10	425	551	9 x 20	686	891
3 x 4	205	269	5 x 7	316	409	7 x 11	447	581			
3 x 5	227	296	5 x 8	337	437	7 x 12	468	607	10 x 10	490	637
3 x 6	249	324	5 x 9	360	464	7 x 13	488	637	10 x 11	514	664
3 x 7	273	352	5 x 10	378	494	7 x 14	511	664	10 x 12	534	693
3 x 8	292	381	5 x 11	401	522	7 x 15	534	693	10 x 13	555	721
3 x 9	314	409	5 x 12	424	550	7 x 16	555	721	10 x 14	578	748
3 x 10	336	437	5 x 13	447	579	7 x 17	578	748	10 x 15	599	777
3 x 11	360	464	5 x 14	468	606	7 x 18	598	777	10 x 16	623	808
3 x 12	378	494	5 x 15	488	635	7 x 19	622	808	10 x 17	642	836
3 x 13	401	522	5 x 16	511	662	7 x 20	641	836	10 x 18	666	863
3 x 14	424	550	5 x 17	531	692				10 x 19	686	891
3 x 15	444	579	5 x 18	554	720	8 x 8	403	523	10 x 20	706	919
3 x 16	467	606	5 x 19	578	746	8 x 9	425	551			
3 x 17	488	635	5 x 20	598	776	8 x 10	447	581			
3 x 18	511	662				8 x 11	468	607			
3 x 19	531	692				8 x 12	488	637			
3 x 20	554	720				8 x 13	514	664			

Kits Include:

- Mill Finish or Dk. Bronze
- Cut to size and mitered retainers (verticals pre-drilled and countersunk)
- One vertical side will be 2Part Extended Frame (1955) with 2Part Retainer (1944) to allow for sliding the rigid plastic face in and out
- All screws required to assemble by mechanical fastening
- All Corner Angles and/or Corner Keys required
- Packaging

Not Included in Kits:

- Face
- Electrical Components
- Divider(s) - See optional accessories
- Mounting Provisions

Optional Accessories (pg 182):

- Divider(s)

Kit Specifications:

- Kits will be cut .265" larger to fit over the existing structure
- Custom size kits may be cut to any dimension
- Illumination may vary depending on application

Divider Kits Include:

- Cut to size dividers
- Divider Corner Angles
- All screws required to assemble by mechanical fastening
- 2Part Divider, Part #1905, Mill Finish \$5.94 and Dk. Bronze \$7.71 per/ft per/face

Additional Information (pgs 196-197)

Unassembled Single Face Kits - For Rigid Faces

2Part 6" S/F Body w/ 2Part Extended Retainer

Part #1926
K1926/1940

Part #1940

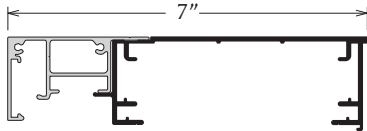

One Side Removable w/
2Part Extended Frame, Part #1955
2Part Retainer, Part #1944

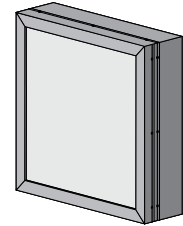

Size H'xW'	Mill Finish	Dk. Bronze	Size H'xW'	Mill Finish	Dk. Bronze	Size H'xW'	Mill Finish	Dk. Bronze	Size H'xW'	Mill Finish	Dk. Bronze
2 x 3	\$242	\$317	4 x 4	\$364	\$471	6 x 6	\$520	\$678	8 x 14	\$916	\$1192
2 x 4	285	368	4 x 5	403	522	6 x 7	560	729	8 x 15	956	1243
2 x 5	322	421	4 x 6	441	575	6 x 8	599	780	8 x 16	998	1295
2 x 6	364	469	4 x 7	483	626	6 x 9	641	832	8 x 17	1037	1346
2 x 7	400	522	4 x 8	520	678	6 x 10	681	884	8 x 18	1073	1397
2 x 8	441	575	4 x 9	560	728	6 x 11	720	934	8 x 19	1114	1447
2 x 9	483	625	4 x 10	599	780	6 x 12	756	985	8 x 20	1153	1500
2 x 10	520	676	4 x 11	641	832	6 x 13	797	1038			
2 x 11	560	728	4 x 12	678	883	6 x 14	837	1088	9 x 9	758	987
2 x 12	599	778	4 x 13	718	934	6 x 15	876	1141	9 x 10	800	1038
2 x 13	639	829	4 x 14	756	985	6 x 16	916	1192	9 x 11	839	1089
2 x 14	678	883	4 x 15	797	1037	6 x 17	956	1241	9 x 12	876	1142
2 x 15	718	932	4 x 16	837	1088	6 x 18	995	1295	9 x 13	916	1192
2 x 16	756	983	4 x 17	876	1141	6 x 19	1035	1346	9 x 14	956	1243
2 x 17	797	1037	4 x 18	915	1189	6 x 20	1073	1395	9 x 15	998	1296
2 x 18	836	1088	4 x 19	954	1241				9 x 16	1037	1346
2 x 19	875	1137	4 x 20	995	1295	7 x 7	599	780	9 x 17	1076	1397
2 x 20	915	1189				7 x 8	641	832	9 x 18	1114	1449
			5 x 5	443	575	7 x 9	681	884	9 x 19	1153	1500
			5 x 6	483	626	7 x 10	720	934	9 x 20	1193	1553
			5 x 7	520	678	7 x 11	758	985			
			5 x 8	560	728	7 x 12	797	1038	10 x 10	839	1089
			5 x 9	599	780	7 x 13	837	1089	10 x 11	878	1142
			5 x 10	641	832	7 x 14	876	1141	10 x 12	916	1192
			5 x 11	681	883	7 x 15	916	1192	10 x 13	956	1243
			5 x 12	718	934	7 x 16	956	1243	10 x 14	998	1296
			5 x 13	756	985	7 x 17	998	1295	10 x 15	1037	1346
			5 x 14	797	1037	7 x 18	1035	1346	10 x 16	1076	1397
			5 x 15	837	1088	7 x 19	1073	1397	10 x 17	1114	1449
			5 x 16	876	1141	7 x 20	1114	1447	10 x 18	1153	1501
			5 x 17	916	1189				10 x 19	1193	1553
			5 x 18	954	1241	8 x 8	681	884	10 x 20	1235	1604
			5 x 19	995	1295	8 x 9	720	935			
			5 x 20	1035	1346	8 x 10	758	985			
						8 x 11	800	1038			
						8 x 12	837	1089			
						8 x 13	876	1141			

Kits Include:

- Mill Finish or Dk. Bronze
- Cut to size and mitered bodies
- Cut to size and mitered retainers (verticals pre-drilled and countersunk)
- One vertical side will be 2Part Extended Frame (1955) with 2Part Retainer (1944) to allow for sliding the rigid plastic face in and out
- All screws required to assemble by mechanical fastening
- All Corner Angles and/or Corner Keys required
- Packaging

Not Included in Kits:

- Face or Back
- Electrical Components
- Ballast Pan(s) - See optional accessories
- Back Braces and Gussets
- Raceway Covers and Cover Screws - See optional accessories
- Divider(s) - See optional accessories
- Mounting Provisions

Optional Accessories (pgs 182-183):

- Ballast Pan(s)
- Raceway Covers and Cover Screws
- Divider(s)

Kit Specifications:

- It is recommended to order kits 1-3/4" over nominal T12 or T8 lamp size to utilize .040 flat Aluminum Raceway Covers
- Custom size kits may be cut to any dimension

Recommended Lamp Spacing:

- For illuminated backgrounds - 8" on center, using T12 or T8 lamps
- Always place lamps 3/4" from back of sign

Divider Kits Include:

- Cut to size dividers
- Divider Corner Angles
- All screws required to assemble by mechanical fastening
- 2Part Divider, Part #1905, Mill Finish \$5.94 and Dk. Bronze \$7.71 per/ft per/face

Additional Information (pgs 196-197)

Note: All dimensions are subject to the tolerance standards of the aluminum extrusion industry. Profile drawings are illustrative and rounded to the nearest 1/16".

CURRENT PRICE as of April 1, 2022



Unassembled Single Face Kits - For Rigid Faces

2Part 8" S/F Body w/ 2Part Extended Retainer

Part #1927
K1927/1940

Part #1940

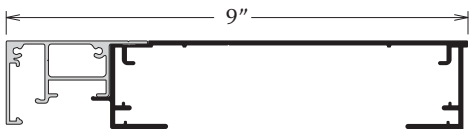

One Side Removable w/
2Part Extended Frame, Part #1955
2Part Retainer, Part #1944

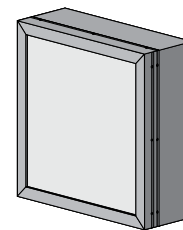

Size H'xW'	Mill Finish	Dk. Bronze	Size H'xW'	Mill Finish	Dk. Bronze	Size H'xW'	Mill Finish	Dk. Bronze	Size H'xW'	Mill Finish	Dk. Bronze
2 x 3	\$280	\$362	4 x 4	\$415	\$541	6 x 6	\$597	\$775	8 x 14	\$1050	\$1365
2 x 4	322	421	4 x 5	460	598	6 x 7	642	834	8 x 15	1095	1423
2 x 5	368	481	4 x 6	507	657	6 x 8	688	891	8 x 16	1140	1481
2 x 6	415	539	4 x 7	550	717	6 x 9	730	951	8 x 17	1184	1539
2 x 7	460	597	4 x 8	597	775	6 x 10	778	1010	8 x 18	1231	1601
2 x 8	507	655	4 x 9	642	834	6 x 11	824	1069	8 x 19	1275	1659
2 x 9	550	715	4 x 10	688	891	6 x 12	869	1129	8 x 20	1322	1718
2 x 10	595	774	4 x 11	730	951	6 x 13	913	1186			
2 x 11	641	833	4 x 12	777	1010	6 x 14	957	1245	9 x 9	869	1130
2 x 12	685	890	4 x 13	822	1069	6 x 15	1004	1303	9 x 10	915	1187
2 x 13	730	950	4 x 14	866	1129	6 x 16	1047	1363	9 x 11	959	1246
2 x 14	777	1009	4 x 15	913	1186	6 x 17	1095	1422	9 x 12	1006	1305
2 x 15	822	1067	4 x 16	957	1245	6 x 18	1140	1479	9 x 13	1050	1365
2 x 16	866	1127	4 x 17	1004	1303	6 x 19	1184	1538	9 x 14	1095	1423
2 x 17	912	1186	4 x 18	1047	1363	6 x 20	1231	1598	9 x 15	1140	1481
2 x 18	956	1245	4 x 19	1094	1422				9 x 16	1184	1539
2 x 19	1004	1303	4 x 20	1138	1479	7 x 7	688	894	9 x 17	1233	1601
2 x 20	1047	1363				7 x 8	731	953	9 x 18	1275	1659
			5 x 5	507	657	7 x 9	778	1011	9 x 19	1322	1718
3 x 3	322	422	5 x 6	551	717	7 x 10	824	1070	9 x 20	1366	1777
3 x 4	369	482	5 x 7	597	775	7 x 11	869	1130			
3 x 5	415	541	5 x 8	642	834	7 x 12	913	1187	10 x 10	959	1246
3 x 6	460	598	5 x 9	688	891	7 x 13	957	1246	10 x 11	1006	1305
3 x 7	507	657	5 x 10	730	951	7 x 14	1004	1305	10 x 12	1050	1365
3 x 8	550	717	5 x 11	777	1010	7 x 15	1050	1365	10 x 13	1095	1423
3 x 9	595	775	5 x 12	822	1069	7 x 16	1095	1423	10 x 14	1140	1481
3 x 10	641	834	5 x 13	869	1129	7 x 17	1140	1481	10 x 15	1186	1539
3 x 11	688	891	5 x 14	913	1186	7 x 18	1184	1539	10 x 16	1233	1601
3 x 12	730	951	5 x 15	957	1245	7 x 19	1231	1601	10 x 17	1275	1659
3 x 13	777	1010	5 x 16	1004	1303	7 x 20	1274	1659	10 x 18	1322	1718
3 x 14	822	1069	5 x 17	1047	1363				10 x 19	1366	1777
3 x 15	866	1129	5 x 18	1094	1422	8 x 8	778	1011	10 x 20	1410	1835
3 x 16	912	1186	5 x 19	1140	1479	8 x 9	824	1070			
3 x 17	957	1245	5 x 20	1184	1538	8 x 10	869	1130			
3 x 18	1004	1303				8 x 11	913	1187			
3 x 19	1047	1363				8 x 12	957	1246			
3 x 20	1094	1422				8 x 13	1006	1305			

Kits Include:

- Mill Finish or Dk. Bronze
- Cut to size and mitered bodies
- Cut to size and mitered retainers (verticals pre-drilled and countersunk)
- One vertical side will be 2Part Extended Frame (1955) with 2Part Retainer (1944) to allow for sliding the rigid plastic face in and out
- All screws required to assemble by mechanical fastening
- All Corner Angles and/or Corner Keys required
- Packaging

Not Included in Kits:

- Face or Back
- Electrical Components
- Ballast Pan(s) - See optional accessories
- Back Braces and Gussets
- Raceway Covers and Cover Screws - See optional accessories
- Divider(s) - See optional accessories
- Mounting Provisions

Optional Accessories (pgs 182-183):

- Ballast Pan(s)
- Raceway Covers and Cover Screws
- Divider(s)

Kit Specifications:

- It is recommended to order kits 1-3/4" over nominal T12 or T8 lamp size to utilize .040 flat Aluminum Raceway Covers
- Custom size kits may be cut to any dimension

Recommended Lamp Spacing:

- For illuminated backgrounds - 12" on center, using T12 or T8 lamps
- Always place lamps 3/4" from back of sign

Divider Kits Include:

- Cut to size dividers
- Divider Corner Angles
- All screws required to assemble by mechanical fastening
- 2Part Divider, Part #1905, Mill Finish \$5.94 and Dk. Bronze \$7.71 per/ft per/face

Additional Information (pgs 196-197)

Unassembled Double Face Kits - For Rigid Faces

2Part 6" D/F Body w/ 2Part Extended Retainer

Part #1936
K1936/1940

Part #1940

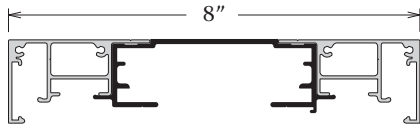

One Side Removable w/
2Part Extended Frame, Part #1955
2Part Retainer, Part #1944

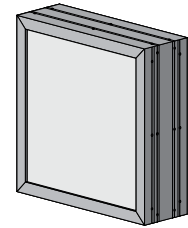

Size H'xW'	Mill Finish	Dk. Bronze	Size H'xW'	Mill Finish	Dk. Bronze	Size H'xW'	Mill Finish	Dk. Bronze	Size H'xW'	Mill Finish	Dk. Bronze
2 x 3	\$292	\$381	4 x 4	\$443	\$575	6 x 6	\$641	\$834	8 x 14	\$1135	\$1473
2 x 4	343	444	4 x 5	491	639	6 x 7	690	896	8 x 15	1183	1536
2 x 5	391	510	4 x 6	541	702	6 x 8	740	959	8 x 16	1233	1602
2 x 6	441	573	4 x 7	589	768	6 x 9	787	1025	8 x 17	1280	1665
2 x 7	490	638	4 x 8	639	830	6 x 10	837	1088	8 x 18	1330	1730
2 x 8	539	699	4 x 9	689	894	6 x 11	885	1151	8 x 19	1379	1793
2 x 9	588	765	4 x 10	739	957	6 x 12	935	1215	8 x 20	1429	1857
2 x 10	638	828	4 x 11	786	1020	6 x 13	984	1278			
2 x 11	688	891	4 x 12	836	1086	6 x 14	1035	1344	9 x 9	940	1218
2 x 12	736	954	4 x 13	884	1149	6 x 15	1083	1407	9 x 10	987	1284
2 x 13	783	1017	4 x 14	934	1214	6 x 16	1132	1472	9 x 11	1036	1347
2 x 14	834	1083	4 x 15	982	1277	6 x 17	1182	1535	9 x 12	1086	1410
2 x 15	882	1146	4 x 16	1033	1343	6 x 18	1231	1601	9 x 13	1135	1475
2 x 16	932	1211	4 x 17	1082	1404	6 x 19	1278	1664	9 x 14	1184	1538
2 x 17	981	1274	4 x 18	1130	1469	6 x 20	1328	1728	9 x 15	1234	1604
2 x 18	1031	1338	4 x 19	1180	1532				9 x 16	1280	1667
2 x 19	1079	1403	4 x 20	1228	1596	7 x 7	742	960	9 x 17	1331	1731
2 x 20	1129	1467				7 x 8	787	1026	9 x 18	1379	1794
			5 x 5	542	704	7 x 9	838	1089	9 x 19	1431	1860
3 x 3	343	446	5 x 6	589	770	7 x 10	887	1154	9 x 20	1478	1923
3 x 4	393	512	5 x 7	641	833	7 x 11	935	1217			
3 x 5	441	575	5 x 8	689	896	7 x 12	985	1280	10 x 10	1038	1349
3 x 6	490	639	5 x 9	740	959	7 x 13	1035	1346	10 x 11	1086	1413
3 x 7	541	699	5 x 10	786	1025	7 x 14	1085	1409	10 x 12	1136	1476
3 x 8	588	765	5 x 11	836	1088	7 x 15	1133	1473	10 x 13	1184	1539
3 x 9	639	828	5 x 12	885	1149	7 x 16	1182	1535	10 x 14	1236	1605
3 x 10	688	891	5 x 13	934	1214	7 x 17	1233	1601	10 x 15	1284	1668
3 x 11	739	956	5 x 14	984	1277	7 x 18	1278	1664	10 x 16	1331	1731
3 x 12	784	1019	5 x 15	1033	1343	7 x 19	1330	1728	10 x 17	1381	1794
3 x 13	834	1085	5 x 16	1083	1406	7 x 20	1378	1791	10 x 18	1431	1860
3 x 14	884	1148	5 x 17	1132	1470				10 x 19	1479	1923
3 x 15	932	1212	5 x 18	1180	1533	8 x 8	838	1091	10 x 20	1529	1988
3 x 16	982	1275	5 x 19	1231	1598	8 x 9	888	1155			
3 x 17	1032	1341	5 x 20	1277	1662	8 x 10	938	1218			
3 x 18	1079	1404				8 x 11	985	1280			
3 x 19	1130	1469				8 x 12	1036	1346			
3 x 20	1177	1532				8 x 13	1085	1409			

Kits Include:

- Mill Finish or Dk. Bronze
- Cut to size and mitered bodies
- Cut to size and mitered retainers (verticals pre-drilled and countersunk)
- One vertical side will be 2Part Extended Frame (1955) with 2Part Retainer (1944) to allow for sliding the rigid plastic face in and out
- All screws required to assemble by mechanical fastening
- All Corner Angles and/or Corner Keys required
- Packaging

Not Included in Kits:

- Faces
- Electrical Components
- Internal Supports
- Divider(s) - See optional accessories

Optional Accessories (pg 182):

- Divider(s)

Kit Specifications:

- It is recommended to order kits 1" over nominal T12 or T8 lamp size to utilize .040 flat Aluminum Raceway Covers
- Custom size kits may be cut to any dimension

Recommended Lamp Spacing:

- For illuminated backgrounds - 7" on center, using T12 or T8 lamps

Divider Kits Include:

- Cut to size dividers
- Divider Corner Angles
- All screws required to assemble by mechanical fastening
- 2Part Divider, Part #1905, Mill Finish \$5.94 and Dk. Bronze \$7.71 per/ft per/face

Additional Information (pgs 196-197)

Note: All dimensions are subject to the tolerance standards of the aluminum extrusion industry. Profile drawings are illustrative and rounded to the nearest 1/16".

CURRENT PRICE as of April 1, 2022



Unassembled Double Face Kits - For Rigid Faces

2Part 9" D/F Body w/ 2Part Extended Retainer

Part #1928
K1928/1940

Part #1940

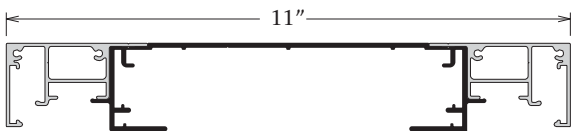

One Side Removable w/
2Part Extended Frame, Part #1955
2Part Retainer, Part #1944

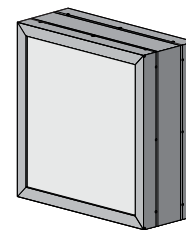

Size H'xW'	Mill Finish	Dk. Bronze	Size H'xW'	Mill Finish	Dk. Bronze	Size H'xW'	Mill Finish	Dk. Bronze	Size H'xW'	Mill Finish	Dk. Bronze
2 x 3	\$362	\$469	4 x 4	\$542	\$704	6 x 6	\$781	\$1014	8 x 14	\$1376	\$1790
2 x 4	423	548	4 x 5	601	781	6 x 7	840	1094	8 x 15	1438	1867
2 x 5	483	626	4 x 6	661	859	6 x 8	900	1172	8 x 16	1497	1946
2 x 6	542	704	4 x 7	721	938	6 x 9	959	1247	8 x 17	1557	2021
2 x 7	599	780	4 x 8	780	1013	6 x 10	1018	1325	8 x 18	1616	2099
2 x 8	661	857	4 x 9	839	1090	6 x 11	1079	1403	8 x 19	1675	2179
2 x 9	720	935	4 x 10	900	1170	6 x 12	1137	1479	8 x 20	1734	2254
2 x 10	778	1011	4 x 11	958	1244	6 x 13	1197	1557			
2 x 11	839	1089	4 x 12	1018	1324	6 x 14	1259	1635	9 x 9	1141	1481
2 x 12	899	1168	4 x 13	1077	1402	6 x 15	1316	1711	9 x 10	1201	1560
2 x 13	958	1244	4 x 14	1136	1478	6 x 16	1376	1788	9 x 11	1260	1636
2 x 14	1015	1323	4 x 15	1197	1556	6 x 17	1435	1866	9 x 12	1318	1714
2 x 15	1076	1400	4 x 16	1257	1633	6 x 18	1497	1944	9 x 13	1378	1791
2 x 16	1136	1477	4 x 17	1316	1709	6 x 19	1556	2021	9 x 14	1438	1867
2 x 17	1195	1554	4 x 18	1375	1788	6 x 20	1612	2097	9 x 15	1498	1946
2 x 18	1257	1632	4 x 19	1434	1865				9 x 16	1557	2023
2 x 19	1315	1708	4 x 20	1495	1942	7 x 7	902	1172	9 x 17	1616	2100
2 x 20	1374	1787				7 x 8	959	1248	9 x 18	1676	2179
			5 x 5	662	859	7 x 9	1019	1327	9 x 19	1734	2254
3 x 3	423	550	5 x 6	721	938	7 x 10	1079	1403	9 x 20	1794	2334
3 x 4	484	626	5 x 7	780	1014	7 x 11	1137	1479			
3 x 5	542	704	5 x 8	840	1090	7 x 12	1199	1558	10 x 10	1260	1637
3 x 6	599	781	5 x 9	900	1170	7 x 13	1259	1635	10 x 11	1319	1714
3 x 7	661	857	5 x 10	959	1247	7 x 14	1318	1711	10 x 12	1378	1791
3 x 8	720	935	5 x 11	1018	1325	7 x 15	1376	1790	10 x 13	1438	1869
3 x 9	780	1013	5 x 12	1077	1402	7 x 16	1435	1867	10 x 14	1498	1948
3 x 10	839	1090	5 x 13	1137	1478	7 x 17	1497	1944	10 x 15	1557	2023
3 x 11	899	1168	5 x 14	1197	1557	7 x 18	1556	2021	10 x 16	1617	2100
3 x 12	958	1244	5 x 15	1259	1635	7 x 19	1616	2099	10 x 17	1676	2180
3 x 13	1015	1324	5 x 16	1316	1709	7 x 20	1675	2175	10 x 18	1734	2256
3 x 14	1077	1400	5 x 17	1375	1788				10 x 19	1794	2334
3 x 15	1136	1477	5 x 18	1435	1866	8 x 8	1019	1327	10 x 20	1854	2412
3 x 16	1195	1556	5 x 19	1495	1942	8 x 9	1079	1404			
3 x 17	1257	1633	5 x 20	1556	2020	8 x 10	1141	1479			
3 x 18	1315	1708				8 x 11	1199	1558			
3 x 19	1375	1787				8 x 12	1260	1636			
3 x 20	1434	1865				8 x 13	1318	1714			

Kits Include:

- Mill Finish or Dk. Bronze
- Cut to size and mitered bodies
- Cut to size and mitered retainers (verticals pre-drilled and countersunk)
- One vertical side will be 2Part Extended Frame (1955) with 2Part Retainer (1944) to allow for sliding the rigid plastic face in and out
- All screws required to assemble by mechanical fastening
- All Corner Angles and/or Corner Keys required
- Packaging

Not Included in Kits:

- Faces
- Electrical Components
- Ballast Pan(s) - See optional accessories
- Internal Supports
- Raceway Covers and Cover Screws - See optional accessories
- Divider(s) - See optional accessories

Optional Accessories (pgs 182-183):

- Ballast Pan(s)
- Raceway Covers and Cover Screws
- Divider(s)

Kit Specifications:

- It is recommended to order kits 1-3/4" over nominal T12 or T8 lamp size to utilize .040 flat Aluminum Raceway Covers
- Custom size kits may be cut to any dimension

Recommended Lamp Spacing:

- For illuminated backgrounds - 8" on center, using T12 or T8 lamps

Divider Kits Include:

- Cut to size dividers
- Divider Corner Angles
- All screws required to assemble by mechanical fastening
- 2Part Divider, Part #1905, Mill Finish \$5.94 and Dk. Bronze \$7.71 per/ft per/face

Additional Information (pgs 196-197)

Unassembled Double Face Kits - For Rigid Faces

2Part 12" D/F Body w/ 2Part Extended Retainer

Part #1929
K1929/1940

Part #1940

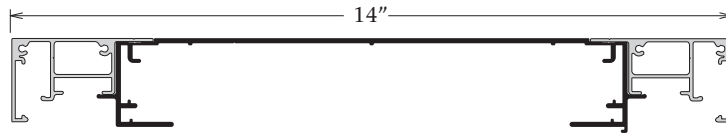

**One Side Removable w/ 2Part Extended Frame, Part #1955
2Part Retainer, Part #1944**

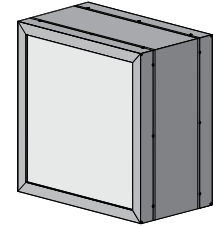

Size H'xW'	Mill Finish	Dk. Bronze	Size H'xW'	Mill Finish	Dk. Bronze	Size H'xW'	Mill Finish	Dk. Bronze	Size H'xW'	Mill Finish	Dk. Bronze
2 x 3	\$411	\$532	4 x 4	\$613	\$796	6 x 6	\$883	\$1145	8 x 14	\$1554	\$2020
2 x 4	476	618	4 x 5	678	883	6 x 7	948	1235	8 x 15	1621	2107
2 x 5	544	705	4 x 6	746	972	6 x 8	1014	1319	8 x 16	1688	2195
2 x 6	611	795	4 x 7	812	1057	6 x 9	1083	1407	8 x 17	1756	2281
2 x 7	678	881	4 x 8	881	1145	6 x 10	1149	1495	8 x 18	1821	2370
2 x 8	746	969	4 x 9	948	1233	6 x 11	1217	1584	8 x 19	1890	2456
2 x 9	811	1055	4 x 10	1013	1318	6 x 12	1284	1668	8 x 20	1957	2542
2 x 10	878	1144	4 x 11	1082	1406	6 x 13	1350	1758			
2 x 11	947	1232	4 x 12	1148	1494	6 x 14	1418	1844	9 x 9	1285	1671
2 x 12	1013	1318	4 x 13	1216	1580	6 x 15	1486	1930	9 x 10	1351	1759
2 x 13	1082	1404	4 x 14	1284	1667	6 x 16	1554	2018	9 x 11	1421	1846
2 x 14	1146	1493	4 x 15	1350	1756	6 x 17	1620	2105	9 x 12	1488	1933
2 x 15	1213	1578	4 x 16	1416	1841	6 x 18	1687	2194	9 x 13	1556	2020
2 x 16	1280	1665	4 x 17	1482	1930	6 x 19	1755	2279	9 x 14	1621	2108
2 x 17	1348	1755	4 x 18	1553	2017	6 x 20	1821	2368	9 x 15	1688	2195
2 x 18	1416	1839	4 x 19	1620	2103				9 x 16	1756	2282
2 x 19	1481	1928	4 x 20	1687	2191	7 x 7	1015	1323	9 x 17	1822	2370
2 x 20	1550	2016				7 x 8	1083	1407	9 x 18	1891	2456
			5 x 5	748	972	7 x 9	1149	1497	9 x 19	1957	2543
			5 x 6	812	1058	7 x 10	1217	1584	9 x 20	2023	2631
			5 x 7	881	1145	7 x 11	1285	1671			
			5 x 8	948	1233	7 x 12	1351	1758	10 x 10	1421	1847
			5 x 9	1014	1319	7 x 13	1418	1844	10 x 11	1488	1933
			5 x 10	1083	1406	7 x 14	1486	1932	10 x 12	1556	2021
			5 x 11	1148	1495	7 x 15	1554	2018	10 x 13	1623	2108
			5 x 12	1216	1580	7 x 16	1621	2107	10 x 14	1691	2196
			5 x 13	1284	1668	7 x 17	1688	2194	10 x 15	1756	2282
			5 x 14	1350	1756	7 x 18	1755	2281	10 x 16	1822	2370
			5 x 15	1418	1844	7 x 19	1821	2368	10 x 17	1891	2457
			5 x 16	1482	1930	7 x 20	1890	2456	10 x 18	1958	2543
			5 x 17	1553	2017				10 x 19	2024	2633
			5 x 18	1620	2105	8 x 8	1149	1497	10 x 20	2092	2718
			5 x 19	1687	2191	8 x 9	1217	1585			
			5 x 20	1755	2279	8 x 10	1285	1671			
						8 x 11	1351	1758			
						8 x 12	1421	1846			
						8 x 13	1486	1932			

Kits Include:

- Mill Finish or Dk. Bronze
- Cut to size and mitered bodies
- Cut to size and mitered retainers (verticals pre-drilled and countersunk)
- One vertical side will be 2Part Extended Frame (1955) with 2Part Retainer (1944) to allow for sliding the rigid plastic face in and out
- All screws required to assemble by mechanical fastening
- All Corner Angles and/or Corner Keys required
- Packaging

Not Included in Kits:

- Faces
- Electrical Components
- Ballast Pan(s) - See optional accessories
- Internal Supports
- Raceway Covers and Cover Screws - See optional accessories
- Divider(s) - See optional accessories

Optional Accessories (pgs 182-183):

- Ballast Pan(s)
- Raceway Covers and Cover Screws
- Divider(s)

Kit Specifications:

- It is recommended to order kits 1-3/4" over nominal T12 or T8 lamp size to utilize .040 flat Aluminum Raceway Covers
- Custom size kits may be cut to any dimension

Recommended Lamp Spacing:

- For illuminated backgrounds - 12" on center, using T12 or T8 lamps

Divider Kits Include:

- Cut to size dividers
- Divider Corner Angles
- All screws required to assemble by mechanical fastening
- 2Part Divider, Part #1905, Mill Finish \$5.94 and Dk. Bronze \$7.71 per/ft per/face

Additional Information (pgs 196-197)

Note: All dimensions are subject to the tolerance standards of the aluminum extrusion industry. Profile drawings are illustrative and rounded to the nearest 1/16".

CURRENT PRICE as of April 1, 2022



Unassembled Single Face Kits - For Rigid Faces

2Part 6" S/F Body w/ 2Part Large Extended Retainer

Part #1926
K1926/1939

Part #1939

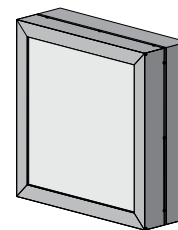
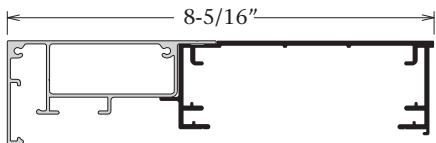

Size H'xW'	Mill Finish	Dk. Bronze	Size H'xW'	Mill Finish	Dk. Bronze	Size H'xW'	Mill Finish	Dk. Bronze	Size H'xW'	Mill Finish	Dk. Bronze
2 x 3	\$262	\$343	4 x 4	\$396	\$514	6 x 6	\$569	\$742	8 x 14	\$1007	\$1304
2 x 4	309	399	4 x 5	440	569	6 x 7	613	796	8 x 15	1050	1363
2 x 5	352	457	4 x 6	483	626	6 x 8	657	853	8 x 16	1095	1419
2 x 6	396	511	4 x 7	526	683	6 x 9	701	911	8 x 17	1138	1477
2 x 7	439	569	4 x 8	569	742	6 x 10	746	966	8 x 18	1180	1532
2 x 8	483	626	4 x 9	613	795	6 x 11	789	1022	8 x 19	1224	1586
2 x 9	526	682	4 x 10	657	853	6 x 12	829	1079	8 x 20	1267	1647
2 x 10	569	738	4 x 11	701	911	6 x 13	875	1136			
2 x 11	613	795	4 x 12	745	964	6 x 14	918	1192	9 x 9	831	1081
2 x 12	657	852	4 x 13	788	1022	6 x 15	962	1249	9 x 10	878	1136
2 x 13	699	907	4 x 14	829	1079	6 x 16	1007	1304	9 x 11	920	1193
2 x 14	745	964	4 x 15	875	1134	6 x 17	1050	1362	9 x 12	962	1251
2 x 15	788	1021	4 x 16	918	1192	6 x 18	1094	1419	9 x 13	1007	1304
2 x 16	829	1077	4 x 17	962	1249	6 x 19	1137	1477	9 x 14	1050	1363
2 x 17	875	1134	4 x 18	1006	1302	6 x 20	1180	1530	9 x 15	1095	1421
2 x 18	916	1192	4 x 19	1046	1362				9 x 16	1138	1477
2 x 19	960	1247	4 x 20	1094	1419	7 x 7	657	853	9 x 17	1181	1532
2 x 20	1006	1302				7 x 8	701	911	9 x 18	1224	1588
						7 x 9	746	966	9 x 19	1267	1647
			5 x 5	484	626	7 x 10	789	1022	9 x 20	1312	1703
			5 x 6	526	683	7 x 11	831	1079			
			5 x 7	569	742	7 x 12	875	1136	10 x 10	920	1193
			5 x 8	613	795	7 x 13	918	1193	10 x 11	963	1251
			5 x 9	657	853	7 x 14	962	1249	10 x 12	1007	1304
			5 x 10	701	911	7 x 15	1007	1304	10 x 13	1050	1363
			5 x 11	746	964	7 x 16	1050	1363	10 x 14	1095	1421
			5 x 12	788	1022	7 x 17	1095	1419	10 x 15	1138	1477
			5 x 13	829	1079	7 x 18	1137	1477	10 x 16	1181	1532
			5 x 14	875	1134	7 x 19	1180	1532	10 x 17	1224	1588
			5 x 15	918	1192	7 x 20	1224	1586	10 x 18	1267	1648
			5 x 16	962	1249				10 x 19	1312	1703
			5 x 17	1007	1302	8 x 8	746	966	10 x 20	1356	1759
			5 x 18	1046	1362	8 x 9	789	1025			
			5 x 19	1094	1419	8 x 10	831	1079			
			5 x 20	1137	1477	8 x 11	878	1136			
						8 x 12	918	1193			
						8 x 13	962	1249			

Kits Include:

- Mill Finish or Dk. Bronze
- Cut to size and mitered bodies
- Cut to size and mitered retainers (verticals pre-drilled and countersunk)
- All screws required to assemble by mechanical fastening
- All Corner Angles and/or Corner Keys required
- Packaging

Not Included in Kits:

- Face or Back
- Electrical Components
- Ballast Pan(s) - See optional accessories
- Back Braces and Gussets
- Raceway Covers and Cover Screws - See optional accessories
- Divider(s) - See optional accessories
- Mounting Provisions

Optional Accessories (pgs 182-183):

- Ballast Pan(s)
- Raceway Covers and Cover Screws
- Divider(s)

Kit Specifications:

- It is recommended to order kits 1-3/4" over nominal T12 or T8 lamp size to utilize .040 flat Aluminum Raceway Covers
- Custom size kits may be cut to any dimension

Recommended Lamp Spacing:

- For illuminated backgrounds - 10" on center, using T12 or T8 lamps
- Always place lamps 3/4" from back of sign

Divider Kits Include:

- Cut to size dividers
- Divider Corner Angles
- All screws required to assemble by mechanical fastening
- 2Part Divider, Part #1905, Mill Finish \$5.94 and Dk. Bronze \$7.71 per/ft per/face

Additional Information (pgs 196-197)

STANDARD

Unassembled Single Face Kits - For Rigid Faces

2Part 8" S/F Body w/ 2Part Large Extended Retainer

Part #1927
K1927/1939

Part #1939

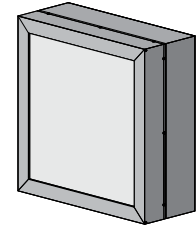
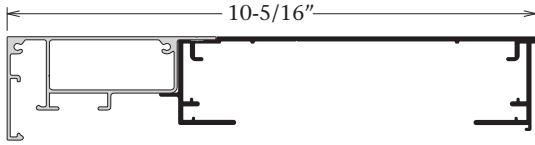

Size H'xW'	Mill Finish	Dk. Bronze	Size H'xW'	Mill Finish	Dk. Bronze	Size H'xW'	Mill Finish	Dk. Bronze	Size H'xW'	Mill Finish	Dk. Bronze
2 x 3	\$301	\$388	4 x 4	\$447	\$583	6 x 6	\$645	\$837	8 x 14	\$1138	\$1478
2 x 4	348	452	4 x 5	496	645	6 x 7	694	902	8 x 15	1189	1544
2 x 5	396	516	4 x 6	547	708	6 x 8	745	964	8 x 16	1239	1605
2 x 6	447	581	4 x 7	595	774	6 x 9	792	1029	8 x 17	1287	1671
2 x 7	496	643	4 x 8	645	837	6 x 10	844	1092	8 x 18	1336	1736
2 x 8	547	706	4 x 9	694	902	6 x 11	895	1158	8 x 19	1387	1799
2 x 9	595	773	4 x 10	745	964	6 x 12	942	1221	8 x 20	1435	1865
2 x 10	643	836	4 x 11	792	1029	6 x 13	991	1284			
2 x 11	693	900	4 x 12	843	1092	6 x 14	1038	1348	9 x 9	942	1223
2 x 12	744	963	4 x 13	891	1158	6 x 15	1089	1413	9 x 10	992	1285
2 x 13	792	1027	4 x 14	939	1221	6 x 16	1137	1477	9 x 11	1039	1350
2 x 14	843	1090	4 x 15	991	1284	6 x 17	1189	1542	9 x 12	1090	1415
2 x 15	891	1157	4 x 16	1038	1348	6 x 18	1239	1604	9 x 13	1138	1478
2 x 16	939	1220	4 x 17	1089	1413	6 x 19	1287	1668	9 x 14	1189	1544
2 x 17	990	1284	4 x 18	1137	1477	6 x 20	1336	1732	9 x 15	1239	1605
2 x 18	1037	1348	4 x 19	1188	1542				9 x 16	1287	1671
2 x 19	1089	1413	4 x 20	1236	1604	7 x 7	745	966	9 x 17	1339	1736
2 x 20	1137	1477				7 x 8	793	1030	9 x 18	1387	1799
			5 x 5	547	708	7 x 9	844	1094	9 x 19	1435	1865
3 x 3	348	455	5 x 6	597	774	7 x 10	895	1160	9 x 20	1483	1926
3 x 4	397	518	5 x 7	645	837	7 x 11	942	1223			
3 x 5	447	583	5 x 8	694	902	7 x 12	991	1285	10 x 10	1039	1350
3 x 6	496	645	5 x 9	745	964	7 x 13	1038	1350	10 x 11	1090	1415
3 x 7	547	708	5 x 10	792	1029	7 x 14	1089	1415	10 x 12	1138	1478
3 x 8	595	774	5 x 11	843	1092	7 x 15	1138	1478	10 x 13	1189	1544
3 x 9	643	837	5 x 12	891	1158	7 x 16	1189	1544	10 x 14	1239	1605
3 x 10	693	902	5 x 13	942	1221	7 x 17	1239	1605	10 x 15	1288	1671
3 x 11	745	964	5 x 14	991	1284	7 x 18	1287	1671	10 x 16	1339	1736
3 x 12	792	1029	5 x 15	1038	1348	7 x 19	1336	1736	10 x 17	1387	1799
3 x 13	843	1092	5 x 16	1089	1413	7 x 20	1384	1799	10 x 18	1435	1865
3 x 14	891	1158	5 x 17	1137	1477				10 x 19	1483	1926
3 x 15	939	1221	5 x 18	1188	1542	8 x 8	844	1094	10 x 20	1533	1990
3 x 16	990	1284	5 x 19	1239	1604	8 x 9	895	1160			
3 x 17	1038	1348	5 x 20	1287	1668	8 x 10	942	1223			
3 x 18	1089	1413				8 x 11	991	1285			
3 x 19	1137	1477				8 x 12	1038	1350			
3 x 20	1188	1542				8 x 13	1090	1415			

Kits Include:

- Mill Finish or Dk. Bronze
- Cut to size and mitered bodies
- Cut to size and mitered retainers (**verticals pre-drilled and countersunk**)
- All screws required to assemble by mechanical fastening
- All Corner Angles and/or Corner Keys required
- Packaging

Not Included in Kits:

- Face or Back
- Electrical Components
- Ballast Pan(s) - See optional accessories
- Back Braces and Gussets
- Raceway Covers and Cover Screws - See optional accessories
- Divider(s) - See optional accessories
- Mounting Provisions

Optional Accessories (pg 182-183):

- Ballast Pan(s)
- Raceway Covers and Cover Screws
- Divider(s)

Kit Specifications:

- It is recommended to order kits 1-3/4" over nominal T12 or T8 lamp size to utilize .040 flat Aluminum Raceway Covers
- Custom size kits may be cut to any dimension

Recommended Lamp Spacing:

- For illuminated backgrounds - 12" on center, using T12 or T8 lamps
- Always place lamps 3/4" from back of sign

Divider Kits Include:

- Cut to size dividers
- Divider Corner Angles
- All screws required to assemble by mechanical fastening
- 2Part Divider, Part #1905, Mill Finish \$5.94 and Dk. Bronze \$7.71 per/ft per/face

Additional Information (pgs 196-197)

Note: All dimensions are subject to the tolerance standards of the aluminum extrusion industry. Profile drawings are illustrative and rounded to the nearest 1/16".

CURRENT PRICE as of April 1, 2022



Unassembled Double Face Kits - For Rigid Faces

2Part 6" D/F Body w/ 2Part Large Extended Retainer

Part #1936
K1936/1939

Part #1939

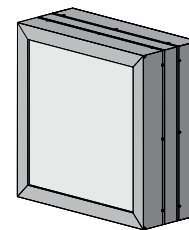
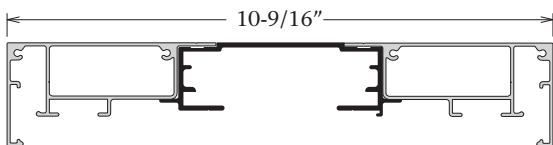

Size H'xW'	Mill Finish	Dk. Bronze	Size H'xW'	Mill Finish	Dk. Bronze	Size H'xW'	Mill Finish	Dk. Bronze	Size H'xW'	Mill Finish	Dk. Bronze
2 x 3	\$333	\$432	4 x 4	\$508	\$657	6 x 6	\$738	\$959	8 x 14	\$1314	\$1702
2 x 4	392	507	4 x 5	564	732	6 x 7	796	1030	8 x 15	1371	1776
2 x 5	448	583	4 x 6	622	807	6 x 8	853	1105	8 x 16	1427	1850
2 x 6	507	655	4 x 7	678	881	6 x 9	911	1180	8 x 17	1483	1925
2 x 7	563	730	4 x 8	736	954	6 x 10	967	1253	8 x 18	1542	2000
2 x 8	621	804	4 x 9	795	1029	6 x 11	1025	1328	8 x 19	1600	2073
2 x 9	677	878	4 x 10	852	1104	6 x 12	1082	1402	8 x 20	1657	2147
2 x 10	734	953	4 x 11	908	1176	6 x 13	1138	1477			
2 x 11	793	1027	4 x 12	966	1252	6 x 14	1197	1553	9 x 9	1086	1404
2 x 12	851	1100	4 x 13	1022	1327	6 x 15	1253	1625	9 x 10	1142	1481
2 x 13	906	1173	4 x 14	1081	1400	6 x 16	1311	1700	9 x 11	1199	1556
2 x 14	964	1249	4 x 15	1137	1474	6 x 17	1370	1775	9 x 12	1257	1629
2 x 15	1021	1324	4 x 16	1196	1550	6 x 18	1426	1849	9 x 13	1314	1703
2 x 16	1079	1397	4 x 17	1252	1623	6 x 19	1482	1923	9 x 14	1372	1778
2 x 17	1136	1471	4 x 18	1309	1697	6 x 20	1540	1998	9 x 15	1430	1853
2 x 18	1193	1546	4 x 19	1367	1771				9 x 16	1483	1926
2 x 19	1249	1621	4 x 20	1425	1844	7 x 7	855	1106	9 x 17	1544	2001
2 x 20	1306	1695				7 x 8	911	1181	9 x 18	1600	2075
			5 x 5	623	808	7 x 9	969	1255	9 x 19	1660	2151
3 x 3	392	508	5 x 6	678	883	7 x 10	1026	1330	9 x 20	1714	2226
3 x 4	450	585	5 x 7	738	958	7 x 11	1082	1403			
3 x 5	507	657	5 x 8	795	1030	7 x 12	1141	1478	10 x 10	1201	1557
3 x 6	563	732	5 x 9	853	1105	7 x 13	1197	1554	10 x 11	1257	1630
3 x 7	622	804	5 x 10	908	1180	7 x 14	1255	1627	10 x 12	1315	1705
3 x 8	677	878	5 x 11	966	1253	7 x 15	1312	1702	10 x 13	1372	1779
3 x 9	736	953	5 x 12	1025	1327	7 x 16	1370	1775	10 x 14	1431	1854
3 x 10	793	1027	5 x 13	1081	1400	7 x 17	1427	1849	10 x 15	1486	1928
3 x 11	852	1102	5 x 14	1138	1474	7 x 18	1482	1923	10 x 16	1544	2001
3 x 12	907	1174	5 x 15	1196	1550	7 x 19	1542	1998	10 x 17	1601	2075
3 x 13	964	1251	5 x 16	1253	1624	7 x 20	1598	2072	10 x 18	1660	2151
3 x 14	1022	1325	5 x 17	1311	1699				10 x 19	1715	2226
3 x 15	1079	1398	5 x 18	1367	1772	8 x 8	969	1257	10 x 20	1772	2298
3 x 16	1137	1473	5 x 19	1426	1846	8 x 9	1027	1331			
3 x 17	1195	1549	5 x 20	1481	1922	8 x 10	1085	1404			
3 x 18	1249	1623				8 x 11	1141	1478			
3 x 19	1309	1697				8 x 12	1199	1554			
3 x 20	1366	1771				8 x 13	1255	1627			

Kits Include:

- Mill Finish or Dk. Bronze
- Cut to size and mitered bodies
- Cut to size and mitered retainers (verticals pre-drilled and countersunk)
- All screws required to assemble by mechanical fastening
- All Corner Angles and/or Corner Keys required
- Packaging

Not Included in Kits:

- Faces
- Electrical Components
- Internal Supports
- Divider(s) - See optional accessories

Optional Accessories (pg 182):

- Divider(s)

Kit Specifications:

- It is recommended to order kits 1" over nominal T12 or T8 lamp size to utilize .040 flat Aluminum Raceway Covers
- Custom size kits may be cut to any dimension

Recommended Lamp Spacing:

- For illuminated backgrounds - 9-1/2" on center, using T12 or T8 lamps

Divider Kits Include:

- Cut to size dividers
- Divider Corner Angles
- All screws required to assemble by mechanical fastening
- 2Part Divider, Part #1905, Mill Finish \$5.94 and Dk. Bronze \$7.71 per/ft per/face

Additional Information (pgs 196-197)

Unassembled Double Face Kits - For Rigid Faces

2Part 9" D/F Body w/ 2Part Large Extended Retainer

Part #1928
K1928/1939

Part #1939

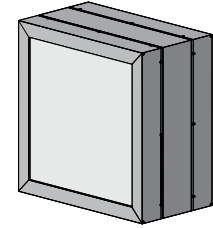
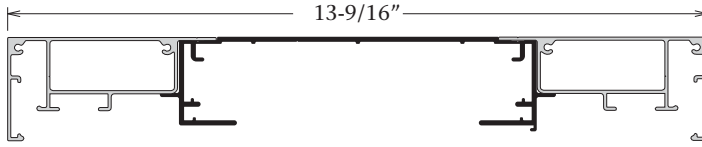

Size H'xW'	Mill Finish	Dk. Bronze	Size H'xW'	Mill Finish	Dk. Bronze	Size H'xW'	Mill Finish	Dk. Bronze	Size H'xW'	Mill Finish	Dk. Bronze
2 x 3	\$403	\$520	4 x 4	\$607	\$785	6 x 6	\$880	\$1138	8 x 14	\$1556	\$2018
2 x 4	471	611	4 x 5	674	875	6 x 7	947	1228	8 x 15	1625	2107
2 x 5	539	699	4 x 6	742	963	6 x 8	1013	1318	8 x 16	1692	2196
2 x 6	607	785	4 x 7	811	1053	6 x 9	1082	1402	8 x 17	1760	2281
2 x 7	673	874	4 x 8	878	1137	6 x 10	1148	1493	8 x 18	1828	2370
2 x 8	742	962	4 x 9	944	1225	6 x 11	1217	1580	8 x 19	1893	2458
2 x 9	809	1050	4 x 10	1013	1316	6 x 12	1284	1665	8 x 20	1962	2544
2 x 10	876	1136	4 x 11	1081	1400	6 x 13	1354	1755			
2 x 11	944	1224	4 x 12	1148	1491	6 x 14	1422	1843	9 x 9	1287	1667
2 x 12	1011	1315	4 x 13	1216	1578	6 x 15	1486	1928	9 x 10	1356	1758
2 x 13	1081	1400	4 x 14	1283	1664	6 x 16	1556	2017	9 x 11	1423	1844
2 x 14	1146	1488	4 x 15	1354	1754	6 x 17	1624	2105	9 x 12	1488	1932
2 x 15	1213	1577	4 x 16	1421	1841	6 x 18	1692	2194	9 x 13	1557	2020
2 x 16	1283	1663	4 x 17	1486	1926	6 x 19	1759	2281	9 x 14	1625	2107
2 x 17	1350	1752	4 x 18	1554	2017	6 x 20	1823	2368	9 x 15	1693	2196
2 x 18	1421	1839	4 x 19	1623	2104				9 x 16	1760	2282
2 x 19	1485	1925	4 x 20	1691	2191	7 x 7	1014	1318	9 x 17	1828	2372
2 x 20	1553	2016				7 x 8	1082	1403	9 x 18	1894	2458
			5 x 5	744	963	7 x 9	1149	1494	9 x 19	1962	2544
			5 x 6	811	1053	7 x 10	1217	1580	9 x 20	2030	2635
			5 x 7	878	1138	7 x 11	1284	1665			
			5 x 8	947	1225	7 x 12	1355	1756	10 x 10	1423	1846
			5 x 9	1013	1316	7 x 13	1422	1843	10 x 11	1491	1932
			5 x 10	1082	1402	7 x 14	1488	1928	10 x 12	1557	2020
			5 x 11	1148	1493	7 x 15	1556	2018	10 x 13	1625	2108
			5 x 12	1216	1578	7 x 16	1624	2107	10 x 14	1693	2198
			5 x 13	1284	1664	7 x 17	1692	2194	10 x 15	1760	2282
			5 x 14	1354	1755	7 x 18	1759	2281	10 x 16	1830	2372
			5 x 15	1422	1843	7 x 19	1828	2370	10 x 17	1894	2460
			5 x 16	1486	1926	7 x 20	1893	2456	10 x 18	1962	2547
			5 x 17	1554	2017				10 x 19	2030	2635
			5 x 18	1624	2105	8 x 8	1149	1494	10 x 20	2097	2722
			5 x 19	1691	2191	8 x 9	1217	1581			
			5 x 20	1759	2279	8 x 10	1287	1665			
						8 x 11	1355	1756			
						8 x 12	1423	1844			
						8 x 13	1488	1932			

Kits Include:

- Mill Finish or Dk. Bronze
- Cut to size and mitered bodies
- Cut to size and mitered retainers (verticals pre-drilled and countersunk)
- All screws required to assemble by mechanical fastening
- All Corner Angles and/or Corner Keys required
- Packaging

Not Included in Kits:

- Faces
- Electrical Components
- Ballast Pan(s) - See optional accessories
- Internal Supports
- Raceway Covers and Cover Screws - See optional accessories
- Divider(s) - See optional accessories

Optional Accessories (pgs 182-183):

- Ballast Pan(s)
- Raceway Covers and Cover Screws
- Divider(s)

Kit Specifications:

- It is recommended to order kits 1-3/4" over nominal T12 or T8 lamp size to utilize .040 flat Aluminum Raceway Covers
- Custom size kits may be cut to any dimension

Recommended Lamp Spacing:

- For illuminated backgrounds - 10" on center, using T12 or T8 lamps

Divider Kits Include:

- Cut to size dividers
- Divider Corner Angles
- All screws required to assemble by mechanical fastening
- 2Part Divider, Part #1905, Mill Finish \$5.94 and Dk. Bronze \$7.71 per/ft per/face

Additional Information (pgs 196-197)

Note: All dimensions are subject to the tolerance standards of the aluminum extrusion industry. Profile drawings are illustrative and rounded to the nearest 1/16".

CURRENT PRICE as of April 1, 2022



Unassembled Double Face Kits - For Rigid Faces

2Part 12" D/F Body w/ 2Part Large Extended Retainer

Part #1929
K1929/1939

Part #1939

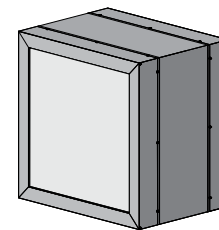
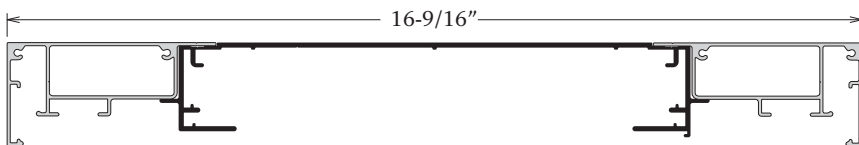

Size H'xW'	Mill Finish	Dk. Bronze	Size H'xW'	Mill Finish	Dk. Bronze	Size H'xW'	Mill Finish	Dk. Bronze	Size H'xW'	Mill Finish	Dk. Bronze
2 x 3	\$450	\$583	4 x 4	\$677	\$878	6 x 6	\$981	\$1269	8 x 14	\$1732	\$2249
2 x 4	524	681	4 x 5	752	976	6 x 7	1054	1370	8 x 15	1809	2347
2 x 5	601	778	4 x 6	827	1076	6 x 8	1129	1466	8 x 16	1885	2442
2 x 6	676	876	4 x 7	903	1170	6 x 9	1207	1562	8 x 17	1960	2540
2 x 7	752	975	4 x 8	979	1269	6 x 10	1280	1661	8 x 18	2032	2640
2 x 8	827	1073	4 x 9	1054	1367	6 x 11	1355	1760	8 x 19	2108	2735
2 x 9	902	1168	4 x 10	1128	1465	6 x 12	1430	1855	8 x 20	2184	2832
2 x 10	976	1268	4 x 11	1205	1561	6 x 13	1505	1954			
2 x 11	1053	1366	4 x 12	1279	1660	6 x 14	1580	2052	9 x 9	1431	1858
2 x 12	1128	1465	4 x 13	1354	1758	6 x 15	1657	2147	9 x 10	1507	1957
2 x 13	1205	1560	4 x 14	1430	1854	6 x 16	1732	2247	9 x 11	1584	2053
2 x 14	1277	1657	4 x 15	1505	1953	6 x 17	1807	2345	9 x 12	1660	2151
2 x 15	1351	1756	4 x 16	1578	2049	6 x 18	1883	2441	9 x 13	1734	2249
2 x 16	1426	1853	4 x 17	1653	2147	6 x 19	1958	2539	9 x 14	1809	2349
2 x 17	1504	1951	4 x 18	1731	2246	6 x 20	2032	2639	9 x 15	1885	2442
2 x 18	1578	2048	4 x 19	1807	2341				9 x 16	1960	2542
2 x 19	1652	2146	4 x 20	1883	2440	7 x 7	1130	1469	9 x 17	2035	2640
2 x 20	1730	2244				7 x 8	1207	1562	9 x 18	2109	2735
			5 x 5	828	1076	7 x 9	1280	1663	9 x 19	2184	2833
3 x 3	526	681	5 x 6	903	1172	7 x 10	1355	1760	9 x 20	2259	2932
3 x 4	602	781	5 x 7	979	1269	7 x 11	1431	1858			
3 x 5	676	876	5 x 8	1054	1367	7 x 12	1507	1954	10 x 10	1584	2055
3 x 6	752	976	5 x 9	1129	1466	7 x 13	1580	2052	10 x 11	1660	2151
3 x 7	827	1073	5 x 10	1207	1561	7 x 14	1657	2149	10 x 12	1734	2250
3 x 8	903	1170	5 x 11	1279	1661	7 x 15	1732	2247	10 x 13	1810	2349
3 x 9	979	1268	5 x 12	1354	1758	7 x 16	1809	2347	10 x 14	1886	2444
3 x 10	1053	1367	5 x 13	1430	1855	7 x 17	1885	2441	10 x 15	1960	2542
3 x 11	1128	1465	5 x 14	1505	1953	7 x 18	1958	2540	10 x 16	2035	2640
3 x 12	1205	1560	5 x 15	1580	2052	7 x 19	2032	2639	10 x 17	2109	2737
3 x 13	1279	1660	5 x 16	1653	2147	7 x 20	2108	2735	10 x 18	2186	2833
3 x 14	1354	1756	5 x 17	1731	2246				10 x 19	2261	2933
3 x 15	1426	1854	5 x 18	1807	2345	8 x 8	1280	1663	10 x 20	2335	3028
3 x 16	1504	1951	5 x 19	1883	2440	8 x 9	1355	1762			
3 x 17	1578	2049	5 x 20	1958	2539	8 x 10	1431	1858			
3 x 18	1653	2146				8 x 11	1507	1954			
3 x 19	1731	2246				8 x 12	1584	2053			
3 x 20	1806	2341				8 x 13	1657	2149			

Kits Include:

- Mill Finish or Dk. Bronze
- Cut to size and mitered bodies
- Cut to size and mitered retainers (verticals pre-drilled and countersunk)
- All screws required to assemble by mechanical fastening
- All Corner Angles and/or Corner Keys required
- Packaging

Not Included in Kits:

- Faces
- Electrical Components
- Ballast Pan(s) - See optional accessories
- Internal Supports
- Raceway Covers and Cover Screws - See optional accessories
- Divider(s) - See optional accessories

Optional Accessories (pgs 182-183):

- Ballast Pan(s)
- Raceway Covers and Cover Screws
- Divider(s)

Kit Specifications:

- It is recommended to order kits 1-3/4" over nominal T12 or T8 lamp size to utilize .040 flat Aluminum Raceway Covers
- Custom size kits may be cut to any dimension

Recommended Lamp Spacing:

- For illuminated backgrounds - 12" on center, using T12 or T8 lamps

Divider Kits Include:

- Cut to size dividers
- Divider Corner Angles
- All screws required to assemble by mechanical fastening
- 2Part Divider, Part #1905, Mill Finish \$5.94 and Dk. Bronze \$7.71 per/ft per/face

Additional Information (pgs 196-197)

Unassembled Retro Kits - For Vandal Retainers

2Part Inner Frame and 2Part Outer Frame

Part #1960
K1960/42

Part #1942

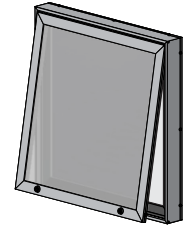
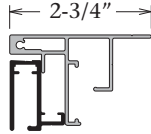

Size H'xW'	Mill Finish	Dk. Bronze	Size H'xW'	Mill Finish	Dk. Bronze	Size H'xW'	Mill Finish	Dk. Bronze	Size H'xW'	Mill Finish	Dk. Bronze
2 x 3	\$234	\$304	4 x 4	\$321	\$416	6 x 6	\$440	\$571	8 x 14	\$745	\$966
2 x 4	262	341	4 x 5	352	456	6 x 7	471	613	8 x 15	776	1006
2 x 5	294	384	4 x 6	383	499	6 x 8	502	651	8 x 16	808	1050
2 x 6	327	423	4 x 7	413	538	6 x 9	534	690	8 x 17	837	1088
2 x 7	357	464	4 x 8	444	578	6 x 10	564	730	8 x 18	867	1129
2 x 8	388	506	4 x 9	475	618	6 x 11	592	773	8 x 19	899	1168
2 x 9	421	546	4 x 10	508	658	6 x 12	625	811	8 x 20	931	1209
2 x 10	448	585	4 x 11	538	698	6 x 13	655	853			
2 x 11	483	625	4 x 12	569	742	6 x 14	688	891	9 x 9	617	800
2 x 12	514	667	4 x 13	599	780	6 x 15	718	934	9 x 10	648	843
2 x 13	544	705	4 x 14	630	821	6 x 16	750	974	9 x 11	678	883
2 x 14	574	748	4 x 15	661	860	6 x 17	780	1014	9 x 12	709	923
2 x 15	606	785	4 x 16	693	900	6 x 18	812	1055	9 x 13	744	963
2 x 16	637	827	4 x 17	724	943	6 x 19	844	1094	9 x 14	771	1003
2 x 17	669	867	4 x 18	755	982	6 x 20	872	1134	9 x 15	804	1043
2 x 18	699	908	4 x 19	788	1022				9 x 16	835	1085
2 x 19	729	950	4 x 20	817	1061	7 x 7	499	646	9 x 17	863	1125
2 x 20	760	990				7 x 8	532	688	9 x 18	896	1165
			5 x 5	380	495	7 x 9	560	728	9 x 19	928	1205
3 x 3	259	338	5 x 6	412	535	7 x 10	591	768	9 x 20	958	1244
3 x 4	292	381	5 x 7	441	575	7 x 11	622	808			
3 x 5	322	419	5 x 8	474	615	7 x 12	654	851	10 x 10	676	880
3 x 6	355	462	5 x 9	506	655	7 x 13	683	888	10 x 11	708	920
3 x 7	384	502	5 x 10	536	694	7 x 14	717	930	10 x 12	738	960
3 x 8	416	541	5 x 11	566	736	7 x 15	748	969	10 x 13	769	999
3 x 9	447	581	5 x 12	598	777	7 x 16	778	1009	10 x 14	800	1041
3 x 10	478	622	5 x 13	626	816	7 x 17	809	1053	10 x 15	831	1082
3 x 11	511	662	5 x 14	658	857	7 x 18	843	1090	10 x 16	860	1120
3 x 12	541	702	5 x 15	690	896	7 x 19	869	1132	10 x 17	895	1162
3 x 13	571	745	5 x 16	721	936	7 x 20	902	1172	10 x 18	923	1201
3 x 14	602	783	5 x 17	752	978				10 x 19	956	1241
3 x 15	633	824	5 x 18	784	1018	8 x 8	555	724	10 x 20	987	1283
3 x 16	666	863	5 x 19	813	1058	8 x 9	587	765			
3 x 17	697	904	5 x 20	847	1098	8 x 10	618	805			
3 x 18	725	947				8 x 11	651	845			
3 x 19	758	985				8 x 12	681	885			
3 x 20	789	1026				8 x 13	714	927			

Kits Include:

- Mill Finish or Dk. Bronze
- Cut to size and mitered Inner/Outer Frame Retainers
- All screws required to assemble by mechanical fastening
- All Corner Angles and/or Corner Keys required
- Cut to size 2Part Hinge
- 2Part Lock(s) and One (1) 2Part Lock Wrench
- Packaging

Not Included in Kits:

- Faces
- Electrical Components
- Drilling of holes for lock(s)
- Attachment of lock(s) and hinge
- Divider(s) - See optional accessories
- Mounting Provisions

Optional Accessories (pg 182):

- Divider(s)

Kit Specifications:

- Kits will be cut .25" larger to fit over the existing structure
- Custom size kits may be cut to any dimension
- Illumination may vary depending on application
- Vandal Retainers are not designed to be used with SignComp Gas Supports

Divider Kits Include:

- Cut to size dividers
- Divider Corner Angles and/or Corner Keys
- All screws required to assemble by mechanical fastening
- 2Part Divider, Part #1905, Mill Finish \$5.94 and Dk. Bronze \$7.71 per/ft per/face
- Header/Reader, Mill Finish \$14.53 and Dk. Bronze \$18.90 per/ft per/face (Includes 2Part Hinge)
- Vandal/Vandal, Mill Finish \$32.16 and Dk. Bronze \$41.84 per/ft per/face (Includes 2Part Hinge)

Additional Information (pgs 196-197)

Note: It is recommended to use safety chains and prop-bars on all hingeable faces.

Note: All dimensions are subject to the tolerance standards of the aluminum extrusion industry. Profile drawings are illustrative and rounded to the nearest 1/16".

CURRENT PRICE as of April 1, 2022



Unassembled Single Face Kits - For Vandal Retainers

2Part 6" S/F Body w/ 2Part Inner Frame and 2Part Outer Frame

Part #1926
K1926/60/42

Part #1960

Part #1942

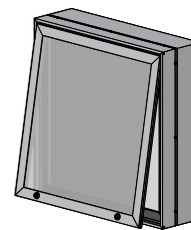
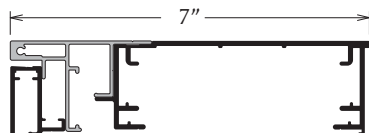

Size H'xW'	Mill Finish	Dk. Bronze	Size H'xW'	Mill Finish	Dk. Bronze	Size H'xW'	Mill Finish	Dk. Bronze	Size H'xW'	Mill Finish	Dk. Bronze
2 x 3	\$316	\$411	4 x 4	\$457	\$594	6 x 6	\$645	\$839	8 x 14	\$1128	\$1465
2 x 4	365	474	4 x 5	507	655	6 x 7	693	902	8 x 15	1174	1528
2 x 5	413	536	4 x 6	552	720	6 x 8	744	964	8 x 16	1221	1590
2 x 6	462	599	4 x 7	601	781	6 x 9	789	1030	8 x 17	1271	1653
2 x 7	511	662	4 x 8	651	845	6 x 10	839	1090	8 x 18	1323	1718
2 x 8	559	725	4 x 9	698	911	6 x 11	888	1156	8 x 19	1371	1782
2 x 9	607	789	4 x 10	748	974	6 x 12	938	1217	8 x 20	1418	1844
2 x 10	655	853	4 x 11	797	1037	6 x 13	985	1280	9 x 9	928	1208
2 x 11	705	916	4 x 12	845	1098	6 x 14	1035	1344	9 x 10	978	1269
2 x 12	753	979	4 x 13	895	1162	6 x 15	1083	1407	9 x 11	1026	1332
2 x 13	804	1042	4 x 14	943	1227	6 x 16	1132	1471	9 x 12	1073	1397
2 x 14	852	1106	4 x 15	990	1290	6 x 17	1180	1533	9 x 13	1121	1461
2 x 15	900	1170	4 x 16	1039	1351	6 x 18	1232	1598	9 x 14	1173	1525
2 x 16	948	1235	4 x 17	1088	1415	6 x 19	1277	1661	9 x 15	1220	1586
2 x 17	998	1296	4 x 18	1137	1478	6 x 20	1327	1725	9 x 16	1269	1651
2 x 18	1045	1360	4 x 19	1186	1540	7 x 7	742	960	9 x 17	1318	1714
2 x 19	1095	1423	4 x 20	1236	1605	7 x 8	788	1025	9 x 18	1366	1776
2 x 20	1144	1486				7 x 9	837	1088	9 x 19	1415	1839
			5 x 5	550	717	7 x 10	885	1150	9 x 20	1465	1901
3 x 3	362	469	5 x 6	598	778	7 x 11	934	1213	10 x 10	1021	1330
3 x 4	411	532	5 x 7	649	843	7 x 12	982	1277	10 x 11	1071	1394
3 x 5	459	597	5 x 8	697	904	7 x 13	1031	1342	10 x 12	1120	1457
3 x 6	508	658	5 x 9	746	969	7 x 14	1082	1404	10 x 13	1170	1522
3 x 7	555	722	5 x 10	795	1034	7 x 15	1130	1469	10 x 14	1217	1584
3 x 8	606	785	5 x 11	843	1095	7 x 16	1177	1530	10 x 15	1267	1647
3 x 9	654	849	5 x 12	890	1160	7 x 17	1227	1595	10 x 16	1315	1708
3 x 10	702	914	5 x 13	939	1220	7 x 18	1274	1656	10 x 17	1364	1772
3 x 11	750	976	5 x 14	988	1291	7 x 19	1324	1721	10 x 18	1413	1837
3 x 12	800	1039	5 x 15	1038	1348	7 x 20	1372	1784	10 x 19	1462	1898
3 x 13	847	1102	5 x 16	1086	1410	8 x 8	835	1085	10 x 20	1509	1962
3 x 14	899	1165	5 x 17	1134	1474	8 x 9	883	1146			
3 x 15	947	1232	5 x 18	1183	1537	8 x 10	931	1211			
3 x 16	995	1293	5 x 19	1233	1602	8 x 11	981	1274			
3 x 17	1042	1356	5 x 20	1279	1665	8 x 12	1030	1336			
3 x 18	1090	1418				8 x 13	1077	1402			
3 x 19	1141	1481									
3 x 20	1188	1546									

Kits Include:

- Mill Finish or Dk. Bronze
- Cut to size and mitered bodies
- Cut to size and mitered Inner/Outer Frame Retainers
- All screws required to assemble by mechanical fastening
- All Corner Angles and/or Corner Keys required
- Cut to size 2Part Hinge
- 2Part Lock(s) and One (1) 2Part Lock Wrench
- Packaging

Not Included in Kits:

- Faces or Back
- Electrical Components
- Ballast Pan(s) - See optional accessories
- Back Braces and Gussets
- Drilling of holes for lock(s)
- Attachment of lock(s) and hinge
- Raceway Covers and Cover Screws - See optional accessories
- Divider(s) - See optional accessories
- Mounting Provisions

Optional Accessories (pgs 182-183):

- Ballast Pan(s)
- Raceway Covers and Cover Screws
- Divider(s)

Kit Specifications:

- It is recommended to order kits 1-3/4" over nominal T12 or T8 lamp size to utilize .040 flat Aluminum Raceway Covers
- Custom size kits may be cut to any dimension
- Vandal Retainers are not designed to be used with SignComp Gas Supports

Recommended Lamp Spacing:

- For illuminated backgrounds - 6" on center, using T12 or T8 lamps
- Always place lamps 3/4" from back of sign

Divider Kits Include:

- Cut to size dividers
- Divider Corner Angles and/or Corner Keys
- All screws required to assemble by mechanical fastening
- 2Part Divider, Part #1905, Mill Finish \$5.94 and Dk. Bronze 7.71 per/ft per/face
- Header/Reader, Mill Finish \$14.53 and Dk. Bronze \$18.90 per/ft per/face (Includes 2Part Hinge)
- Vandal/Vandal, Mill Finish \$32.16 and Dk. Bronze \$41.84 per/ft per/face (Includes 2Part Hinge)

Additional Information (pgs 196-197)

Note: It is recommended to use safety chains and prop-bars on all hingeable faces.

Unassembled Single Face Kits - For Vandal Retainers

2Part 8" S/F Body w/ 2Part Inner Frame and 2Part Outer Frame

Part #1927
K1927/60/42

Part #1960

Part #1942

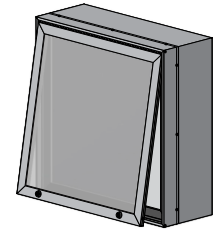
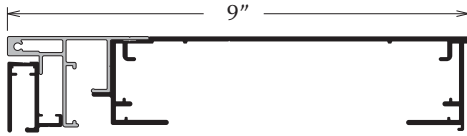

Size H'xW'	Mill Finish	Dk. Bronze	Size H'xW'	Mill Finish	Dk. Bronze	Size H'xW'	Mill Finish	Dk. Bronze	Size H'xW'	Mill Finish	Dk. Bronze
2 x 3	\$352	\$456	4 x 4	\$510	\$661	6 x 6	\$721	\$938	8 x 14	\$1260	\$1637
2 x 4	404	524	4 x 5	563	730	6 x 7	776	1009	8 x 15	1315	1708
2 x 5	460	597	4 x 6	617	804	6 x 8	829	1079	8 x 16	1371	1782
2 x 6	515	667	4 x 7	671	874	6 x 9	884	1148	8 x 17	1423	1850
2 x 7	569	740	4 x 8	725	944	6 x 10	939	1218	8 x 18	1478	1922
2 x 8	623	809	4 x 9	780	1014	6 x 11	991	1291	8 x 19	1532	1992
2 x 9	678	881	4 x 10	836	1086	6 x 12	1046	1362	8 x 20	1588	2064
2 x 10	730	951	4 x 11	888	1157	6 x 13	1102	1432	9 x 9	1039	1350
2 x 11	785	1021	4 x 12	944	1228	6 x 14	1157	1502	9 x 10	1094	1422
2 x 12	840	1094	4 x 13	999	1299	6 x 15	1211	1574	9 x 11	1148	1494
2 x 13	896	1164	4 x 14	1054	1371	6 x 16	1267	1644	9 x 12	1202	1562
2 x 14	950	1236	4 x 15	1106	1441	6 x 17	1319	1716	9 x 13	1259	1635
2 x 15	1006	1304	4 x 16	1162	1510	6 x 18	1375	1787	9 x 14	1311	1705
2 x 16	1058	1376	4 x 17	1217	1584	6 x 19	1430	1858	9 x 15	1366	1776
2 x 17	1114	1447	4 x 18	1271	1653	6 x 20	1482	1928	9 x 16	1421	1847
2 x 18	1168	1520	4 x 19	1327	1725	7 x 7	827	1073	9 x 17	1474	1919
2 x 19	1221	1589	4 x 20	1379	1793	7 x 8	883	1145	9 x 18	1529	1989
2 x 20	1275	1661				7 x 9	935	1216	9 x 19	1585	2060
			5 x 5	614	800	7 x 10	990	1287	9 x 20	1637	2130
3 x 3	400	522	5 x 6	670	871	7 x 11	1043	1358	10 x 10	1145	1491
3 x 4	457	594	5 x 7	722	942	7 x 12	1100	1430	10 x 11	1201	1560
3 x 5	511	664	5 x 8	778	1011	7 x 13	1153	1500	10 x 12	1253	1632
3 x 6	566	736	5 x 9	832	1083	7 x 14	1209	1570	10 x 13	1309	1702
3 x 7	618	807	5 x 10	887	1153	7 x 15	1264	1640	10 x 14	1363	1772
3 x 8	674	876	5 x 11	942	1224	7 x 16	1318	1711	10 x 15	1418	1844
3 x 9	729	948	5 x 12	998	1296	7 x 17	1372	1784	10 x 16	1471	1914
3 x 10	783	1018	5 x 13	1050	1366	7 x 18	1427	1854	10 x 17	1528	1986
3 x 11	839	1089	5 x 14	1105	1438	7 x 19	1479	1925	10 x 18	1580	2055
3 x 12	891	1161	5 x 15	1160	1505	7 x 20	1534	1996	10 x 19	1636	2127
3 x 13	948	1233	5 x 16	1213	1577	8 x 8	932	1212	10 x 20	1691	2198
3 x 14	1003	1302	5 x 17	1268	1649	8 x 9	987	1284			
3 x 15	1057	1374	5 x 18	1324	1719	8 x 10	1041	1355			
3 x 16	1111	1443	5 x 19	1376	1790	8 x 11	1097	1425			
3 x 17	1165	1516	5 x 20	1432	1862	8 x 12	1149	1497			
3 x 18	1218	1586				8 x 13	1207	1565			
3 x 19	1274	1656									
3 x 20	1328	1728									

Kits Include:

- Mill Finish or Dk. Bronze
- Cut to size and mitered bodies
- Cut to size and mitered Inner/Outer Frame Retainers
- All screws required to assemble by mechanical fastening
- All Corner Angles and/or Corner Keys required
- Cut to size 2Part Hinge
- 2Part Lock(s) and One (1) 2Part Lock Wrench
- Packaging

Not Included in Kits:

- Faces or Back
- Electrical Components
- Ballast Pan(s) - See optional accessories
- Back Braces and Gussets
- Drilling of holes for lock(s)
- Attachment of lock(s) and hinge
- Raceway Covers and Cover Screws - See optional accessories
- Divider(s) - See optional accessories
- Mounting Provisions

Optional Accessories (pgs 182-183):

- Ballast Pan(s)
- Raceway Covers and Cover Screws
- Divider(s)

Kit Specifications:

- It is recommended to order kits 1-3/4" over nominal T12 or T8 lamp size to utilize .040 flat Aluminum Raceway Covers
- Custom size kits may be cut to any dimension
- Vandal Retainers are not designed to be used with SignComp Gas Supports

Recommended Lamp Spacing:

- For illuminated backgrounds - 10" on center, using T12 or T8 lamps
- Always place lamps 3/4" from back of sign

Divider Kits Include:

- Cut to size dividers
- Divider Corner Angles and/or Corner Keys
- All screws required to assemble by mechanical fastening
- 2Part Divider, Part #1905, Mill Finish \$5.94 and Dk. Bronze \$7.71 per/ft per/face
- Header/Reader, Mill Finish \$14.53 and Dk. Bronze \$18.90 per/ft per/face (Includes 2Part Hinge)
- Vandal/Vandal, Mill Finish \$32.16 and Dk. Bronze \$41.84 per/ft per/face (Includes 2Part Hinge)

Additional Information (pgs 196-197)

Note: It is recommended to use safety chains and prop-bars on all hingeable faces.

Note: All dimensions are subject to the tolerance standards of the aluminum extrusion industry. Profile drawings are illustrative and rounded to the nearest 1/16".

CURRENT PRICE as of April 1, 2022



Unassembled Double Face Kits - For Vandal Retainers

2Part 6" D/F Body w/ 2Part Inner Frame and 2Part Outer Frame

Part #1936
K1936/60/42

Part #1960

Part #1942

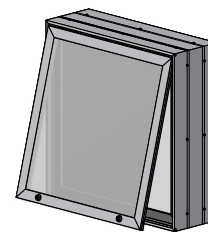
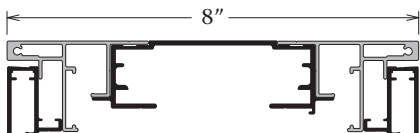

Size H'xW'	Mill Finish	Dk. Bronze	Size H'xW'	Mill Finish	Dk. Bronze	Size H'xW'	Mill Finish	Dk. Bronze	Size H'xW'	Mill Finish	Dk. Bronze
2 x 3	\$432	\$564	4 x 4	\$626	\$812	6 x 6	\$885	\$1150	8 x 14	\$1554	\$2018
2 x 4	500	651	4 x 5	693	902	6 x 7	954	1240	8 x 15	1621	2107
2 x 5	569	740	4 x 6	760	988	6 x 8	1021	1328	8 x 16	1688	2195
2 x 6	638	827	4 x 7	812	1077	6 x 9	1089	1416	8 x 17	1758	2282
2 x 7	704	915	4 x 8	899	1165	6 x 10	1157	1504	8 x 18	1823	2372
2 x 8	773	1004	4 x 9	964	1253	6 x 11	1224	1593	8 x 19	1893	2458
2 x 9	839	1090	4 x 10	1034	1343	6 x 12	1293	1681	8 x 20	1960	2547
2 x 10	908	1180	4 x 11	1100	1431	6 x 13	1362	1768	9 x 9	1275	1661
2 x 11	976	1268	4 x 12	1168	1520	6 x 14	1430	1858	9 x 10	1344	1751
2 x 12	1042	1356	4 x 13	1236	1607	6 x 15	1497	1944	9 x 11	1413	1837
2 x 13	1111	1443	4 x 14	1303	1695	6 x 16	1562	2032	9 x 12	1479	1923
2 x 14	1177	1532	4 x 15	1372	1784	6 x 17	1632	2121	9 x 13	1548	2013
2 x 15	1247	1621	4 x 16	1439	1870	6 x 18	1700	2210	9 x 14	1616	2099
2 x 16	1315	1708	4 x 17	1505	1958	6 x 19	1767	2297	9 x 15	1683	2187
2 x 17	1381	1795	4 x 18	1574	2047	6 x 20	1835	2385	9 x 16	1752	2277
2 x 18	1449	1885	4 x 19	1640	2133	7 x 7	1015	1323	9 x 17	1819	2363
2 x 19	1518	1970	4 x 20	1709	2222	7 x 8	1085	1409	9 x 18	1886	2452
2 x 20	1585	2060				7 x 9	1150	1498	9 x 19	1954	2540
			5 x 5	755	982	7 x 10	1218	1586	9 x 20	2021	2630
3 x 3	495	643	5 x 6	824	1070	7 x 11	1287	1675	10 x 10	1406	1830
3 x 4	564	730	5 x 7	890	1160	7 x 12	1356	1762	10 x 11	1474	1916
3 x 5	630	820	5 x 8	959	1247	7 x 13	1423	1850	10 x 12	1544	2004
3 x 6	698	908	5 x 9	1029	1335	7 x 14	1493	1937	10 x 13	1609	2093
3 x 7	768	998	5 x 10	1095	1423	7 x 15	1558	2024	10 x 14	1677	2182
3 x 8	835	1085	5 x 11	1162	1510	7 x 16	1625	2114	10 x 15	1746	2271
3 x 9	903	1173	5 x 12	1232	1601	7 x 17	1693	2200	10 x 16	1815	2357
3 x 10	972	1263	5 x 13	1299	1688	7 x 18	1762	2289	10 x 17	1882	2445
3 x 11	1038	1348	5 x 14	1366	1776	7 x 19	1830	2380	10 x 18	1950	2535
3 x 12	1105	1438	5 x 15	1434	1865	7 x 20	1897	2467	10 x 19	2017	2622
3 x 13	1173	1526	5 x 16	1501	1951	8 x 8	1146	1493	10 x 20	2083	2710
3 x 14	1240	1612	5 x 17	1569	2040	8 x 9	1213	1578			
3 x 15	1309	1702	5 x 18	1636	2127	8 x 10	1280	1667			
3 x 16	1376	1790	5 x 19	1705	2216	8 x 11	1348	1756			
3 x 17	1443	1879	5 x 20	1772	2305	8 x 12	1418	1844			
3 x 18	1510	1965				8 x 13	1486	1930			
3 x 19	1578	2052									
3 x 20	1649	2142									

Kits Include:

- Mill Finish or Dk. Bronze
- Cut to size and mitered bodies
- Cut to size and mitered Inner/Outer Frame Retainers
- All screws required to assemble by mechanical fastening
- All Corner Angles and/or Corner Keys required
- Cut to size 2Part Hinge
- 2Part Lock(s) and One (1) 2Part Lock Wrench
- Packaging

Not Included in Kits:

- Faces
- Electrical Components
- Internal Supports
- Drilling of holes for lock(s)
- Attachment of lock(s) and hinge
- Divider(s) - See optional accessories

Optional Accessories (pg 182):

- Divider(s)

Kit Specifications:

- It is recommended to order kits 1" over nominal T12 or T8 lamp size to utilize .040 flat Aluminum Raceway Covers
- Custom size kits may be cut to any dimension
- Vandal Retainers are not designed to be used with SignComp Gas Supports

Recommended Lamp Spacing:

- For illuminated backgrounds - 5" on center, using T12 or T8 lamps

Divider Kits Include:

- Cut to size dividers
- Divider Corner Angles and/or Corner Keys
- All screws required to assemble by mechanical fastening
- 2Part Divider, Part #1905, Mill Finish \$5.94 and Dk. Bronze \$7.71 per/ft per/face
- Header/Reader, Mill Finish \$14.53 and Dk. Bronze \$18.90 per/ft per/face (Includes 2Part Hinge)
- Vandal/Vandal, Mill Finish \$32.16 and Dk. Bronze \$41.84 per/ft per/face (Includes 2Part Hinge)

Additional Information (pgs 196-197)

Note: It is recommended to use safety chains and prop-bars on all hingeable faces.

Unassembled Double Face Kits - For Vandal Retainers

2Part 9" D/F Body w/ 2Part Inner Frame and 2Part Outer Frame

Part #1928
K1928/60/42

Part #1960

Part #1942

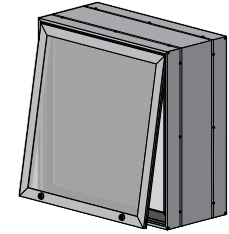
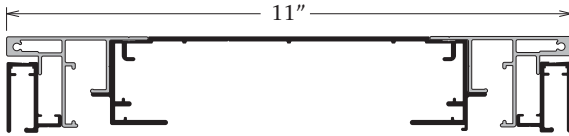

Size H'xW'	Mill Finish	Dk. Bronze	Size H'xW'	Mill Finish	Dk. Bronze	Size H'xW'	Mill Finish	Dk. Bronze	Size H'xW'	Mill Finish	Dk. Bronze
2 x 3	\$508	\$658	4 x 4	\$728	\$948	6 x 6	\$1030	\$1339	8 x 14	\$1798	\$2338
2 x 4	585	758	4 x 5	808	1050	6 x 7	1106	1441	8 x 15	1877	2441
2 x 5	662	860	4 x 6	885	1149	6 x 8	1186	1540	8 x 16	1954	2540
2 x 6	742	960	4 x 7	963	1251	6 x 9	1265	1641	8 x 17	2032	2643
2 x 7	817	1065	4 x 8	1041	1351	6 x 10	1343	1746	8 x 18	2109	2742
2 x 8	896	1165	4 x 9	1118	1454	6 x 11	1421	1846	8 x 19	2187	2845
2 x 9	975	1267	4 x 10	1197	1557	6 x 12	1498	1948	8 x 20	2269	2947
2 x 10	1051	1367	4 x 11	1274	1656	6 x 13	1576	2048	9 x 9	1479	1925
2 x 11	1132	1470	4 x 12	1351	1759	6 x 14	1653	2151	9 x 10	1558	2026
2 x 12	1209	1570	4 x 13	1431	1862	6 x 15	1731	2251	9 x 11	1636	2127
2 x 13	1287	1672	4 x 14	1509	1961	6 x 16	1809	2353	9 x 12	1716	2228
2 x 14	1364	1775	4 x 15	1588	2064	6 x 17	1890	2454	9 x 13	1793	2330
2 x 15	1442	1874	4 x 16	1665	2165	6 x 18	1966	2556	9 x 14	1870	2432
2 x 16	1522	1977	4 x 17	1742	2265	6 x 19	2045	2656	9 x 15	1950	2535
2 x 17	1598	2077	4 x 18	1821	2368	6 x 20	2123	2761	9 x 16	2026	2635
2 x 18	1676	2180	4 x 19	1898	2470	7 x 7	1180	1533	9 x 17	2105	2737
2 x 19	1755	2281	4 x 20	1977	2570	7 x 8	1259	1636	9 x 18	2183	2838
2 x 20	1834	2382				7 x 9	1336	1736	9 x 19	2259	2937
			5 x 5	878	1144	7 x 10	1415	1838	9 x 20	2338	3039
3 x 3	579	752	5 x 6	958	1244	7 x 11	1494	1940	10 x 10	1632	2121
3 x 4	657	855	5 x 7	1037	1346	7 x 12	1570	2042	10 x 11	1708	2222
3 x 5	736	954	5 x 8	1114	1447	7 x 13	1649	2143	10 x 12	1787	2323
3 x 6	812	1057	5 x 9	1192	1550	7 x 14	1727	2244	10 x 13	1865	2425
3 x 7	890	1157	5 x 10	1269	1651	7 x 15	1804	2345	10 x 14	1944	2527
3 x 8	969	1260	5 x 11	1347	1754	7 x 16	1882	2448	10 x 15	2021	2627
3 x 9	1045	1362	5 x 12	1425	1759	7 x 17	1960	2547	10 x 16	2099	2730
3 x 10	1122	1462	5 x 13	1502	1954	7 x 18	2037	2649	10 x 17	2179	2830
3 x 11	1202	1562	5 x 14	1580	2055	7 x 19	2116	2750	10 x 18	2254	2932
3 x 12	1280	1665	5 x 15	1661	2156	7 x 20	2195	2852	10 x 19	2334	3033
3 x 13	1360	1764	5 x 16	1737	2258	8 x 8	1330	1730	10 x 20	2412	3134
3 x 14	1438	1867	5 x 17	1816	2360	8 x 9	1407	1833			
3 x 15	1516	1969	5 x 18	1894	2460	8 x 10	1486	1932			
3 x 16	1593	2069	5 x 19	1970	2564	8 x 11	1564	2035			
3 x 17	1671	2172	5 x 20	2049	2665	8 x 12	1641	2135			
3 x 18	1751	2275				8 x 13	1721	2237			
3 x 19	1826	2374									
3 x 20	1905	2477									

Kits Include:

- Mill Finish or Dk. Bronze
- Cut to size and mitered bodies
- Cut to size and mitered Inner/Outer Frame Retainers
- All screws required to assemble by mechanical fastening
- All Corner Angles and/or Corner Keys required
- Cut to size 2Part Hinge
- 2Part Lock(s) and One (1) 2Part Lock Wrench
- Packaging

Not Included in Kits:

- Faces
- Electrical Components
- Ballast Pan(s) - See optional accessories
- Internal Supports
- Drilling of holes for lock(s)
- Attachment of lock(s) and hinge
- Raceway Covers and Cover Screws - See optional accessories
- Divider(s) - See optional accessories

Optional Accessories (182-183):

- Ballast Pan(s)
- Raceway Covers and Cover Screws
- Divider(s)

Kit Specifications:

- It is recommended to order kits 1-3/4" over nominal T12 or T8 lamp size to utilize .040 flat Aluminum Raceway Covers
- Custom size kits may be cut to any dimension
- Vandal Retainers are not designed to be used with SignComp Gas Supports

Recommended Lamp Spacing:

- For illuminated backgrounds - 7" on center, using T12 or T8 lamps

Divider Kits Include:

- Cut to size dividers
- Divider Corner Angles and/or Corner Keys
- All screws required to assemble by mechanical fastening
- 2Part Divider, Part #1905, Mill Finish \$5.94 and Dk. Bronze \$7.71 per/ft per/face
- Header/Reader, Mill Finish \$14.53 and Dk. Bronze \$18.90 per/ft per/face (Includes 2Part Hinge)
- Vandal/Vandal, Mill Finish \$32.16 and Dk. Bronze \$41.84 per/ft per/face (Includes 2Part Hinge)

Additional Information (pgs 196-197)

Note: It is recommended to use safety chains and prop-bars on all hingeable faces.

Note: All dimensions are subject to the tolerance standards of the aluminum extrusion industry. Profile drawings are illustrative and rounded to the nearest 1/16".

CURRENT PRICE as of April 1, 2022



Unassembled Double Face Kits - For Vandal Retainers

2Part 12" D/F Body w/ 2Part Inner Frame and 2Part Outer Frame

Part #1929
K1929/60/42

Part #1960

Part #1942

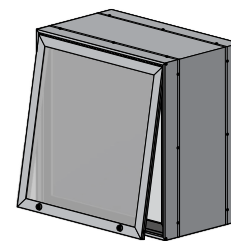
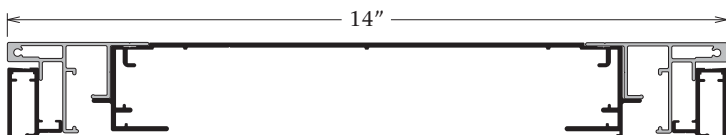

Size H'xW'	Mill Finish	Dk. Bronze	Size H'xW'	Mill Finish	Dk. Bronze	Size H'xW'	Mill Finish	Dk. Bronze	Size H'xW'	Mill Finish	Dk. Bronze
2 x 3	\$552	\$720	4 x 4	\$800	\$1038	6 x 6	\$1130	\$1469	8 x 14	\$1976	\$2567
2 x 4	639	829	4 x 5	884	1148	6 x 7	1216	1578	8 x 15	2060	2677
2 x 5	724	942	4 x 6	972	1263	6 x 8	1300	1692	8 x 16	2146	2791
2 x 6	809	1054	4 x 7	1055	1372	6 x 9	1388	1803	8 x 17	2230	2901
2 x 7	896	1164	4 x 8	1142	1482	6 x 10	1471	1913	8 x 18	2317	3012
2 x 8	981	1274	4 x 9	1227	1595	6 x 11	1558	2024	8 x 19	2402	3123
2 x 9	1067	1388	4 x 10	1314	1705	6 x 12	1641	2135	8 x 20	2488	3234
2 x 10	1150	1498	4 x 11	1397	1818	6 x 13	1730	2249	9 x 9	1625	2114
2 x 11	1239	1608	4 x 12	1482	1928	6 x 14	1815	2358	9 x 10	1711	2226
2 x 12	1324	1721	4 x 13	1569	2040	6 x 15	1900	2470	9 x 11	1795	2337
2 x 13	1409	1833	4 x 14	1655	2152	6 x 16	1986	2583	9 x 12	1883	2448
2 x 14	1495	1942	4 x 15	1739	2261	6 x 17	2073	2693	9 x 13	1968	2559
2 x 15	1580	2053	4 x 16	1826	2373	6 x 18	2156	2802	9 x 14	2053	2671
2 x 16	1665	2165	4 x 17	1911	2485	6 x 19	2244	2916	9 x 15	2140	2782
2 x 17	1754	2278	4 x 18	1997	2596	6 x 20	2328	3027	9 x 16	2226	2893
2 x 18	1837	2388	4 x 19	2081	2707	7 x 7	1296	1683	9 x 17	2310	3003
2 x 19	1923	2501	4 x 20	2168	2819	7 x 8	1379	1794	9 x 18	2397	3117
2 x 20	2009	2612				7 x 9	1467	1906	9 x 19	2481	3228
			5 x 5	963	1253	7 x 10	1553	2018	9 x 20	2568	3337
3 x 3	631	824	5 x 6	1050	1364	7 x 11	1637	2128	10 x 10	1791	2329
3 x 4	718	934	5 x 7	1134	1474	7 x 12	1724	2242	10 x 11	1879	2441
3 x 5	805	1043	5 x 8	1220	1588	7 x 13	1809	2353	10 x 12	1962	2554
3 x 6	888	1157	5 x 9	1304	1699	7 x 14	1894	2461	10 x 13	2049	2663
3 x 7	976	1268	5 x 10	1393	1809	7 x 15	1982	2572	10 x 14	2133	2773
3 x 8	1061	1378	5 x 11	1477	1922	7 x 16	2065	2686	10 x 15	2221	2885
3 x 9	1146	1493	5 x 12	1562	2032	7 x 17	2152	2797	10 x 16	2306	2998
3 x 10	1233	1602	5 x 13	1649	2143	7 x 18	2237	2907	10 x 17	2390	3107
3 x 11	1318	1711	5 x 14	1734	2254	7 x 19	2323	3022	10 x 18	2477	3221
3 x 12	1403	1823	5 x 15	1819	2363	7 x 20	2409	3131	10 x 19	2564	3332
3 x 13	1491	1935	5 x 16	1906	2477	8 x 8	1462	1898	10 x 20	2647	3440
3 x 14	1574	2048	5 x 17	1990	2588	8 x 9	1546	2012			
3 x 15	1661	2158	5 x 18	2077	2701	8 x 10	1633	2123			
3 x 16	1746	2271	5 x 19	2160	2813	8 x 11	1718	2231			
3 x 17	1833	2382	5 x 20	2249	2923	8 x 12	1804	2342			
3 x 18	1916	2491				8 x 13	1890	2456			
3 x 19	2001	2603									
3 x 20	2088	2715									

Kits Include:

- Mill Finish or Dk. Bronze
- Cut to size and mitered bodies
- Cut to size and mitered Inner/Outer Frame Retainers
- All screws required to assemble by mechanical fastening
- All Corner Angles and/or Corner Keys required
- Cut to size 2Part Hinge
- 2Part Lock(s) and One (1) 2Part Lock Wrench
- Packaging

Not Included in Kits:

- Faces
- Electrical Components
- Ballast Pan(s) - See optional accessories
- Internal Supports
- Drilling of holes for lock(s)
- Attachment of lock(s) and hinge
- Raceway Covers and Cover Screws - See optional accessories
- Divider(s) - See optional accessories

Optional Accessories (182-183):

- Ballast Pan(s)
- Raceway Covers and Cover Screws
- Divider(s)

Kit Specifications:

- It is recommended to order kits 1-3/4" over nominal T12 or T8 lamp size to utilize .040 flat Aluminum Raceway Covers
- Custom size kits may be cut to any dimension
- Vandal Retainers are not designed to be used with SignComp Gas Supports

Recommended Lamp Spacing:

- For illuminated backgrounds - 9" on center, using T12 or T8 lamps

Divider Kits Include:

- Cut to size dividers
- Divider Corner Angles and/or Corner Keys
- All screws required to assemble by mechanical fastening
- 2Part Divider, Part #1905, Mill Finish \$5.94 and Dk. Bronze \$7.71 per/ft per/face
- Header/Reader, Mill Finish \$14.53 and Dk. Bronze \$18.90 per/ft per/face (Includes 2Part Hinge)
- Vandal/Vandal, Mill Finish \$32.16 and Dk. Bronze \$41.84 per/ft per/face (Includes 2Part Hinge)

Additional Information (pgs 196-197)

Note: It is recommended to use safety chains and prop-bars on all hingeable faces.

Note: All dimensions are subject to the tolerance standards of the aluminum extrusion industry. Profile drawings are illustrative and rounded to the nearest 1/16".

CURRENT PRICE as of April 1, 2022



Unassembled Single Face Kits - For Vandal Retainers

2Part 6" S/F Body w/ 2Part Large Inner Frame and 2Part Large Outer Frame

Part #1926
K1926/59/41

Part #1959

Part #1941

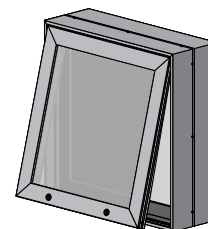
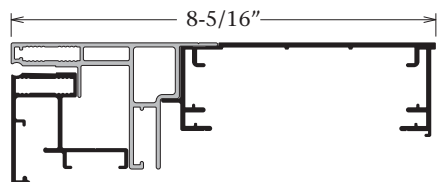

Size H'xW'	Mill Finish	Dk. Bronze	Size H'xW'	Mill Finish	Dk. Bronze	Size H'xW'	Mill Finish	Dk. Bronze	Size H'xW'	Mill Finish	Dk. Bronze
2 x 3	\$443	\$575	4 x 4	\$651	\$844	6 x 6	\$928	\$1208	8 x 14	\$1640	\$2133
2 x 4	515	667	4 x 5	721	938	6 x 7	1003	1302	8 x 15	1714	2227
2 x 5	586	761	4 x 6	795	1034	6 x 8	1073	1395	8 x 16	1786	2322
2 x 6	658	856	4 x 7	867	1128	6 x 9	1145	1491	8 x 17	1858	2414
2 x 7	729	950	4 x 8	938	1218	6 x 10	1217	1584	8 x 18	1930	2508
2 x 8	804	1042	4 x 9	1010	1314	6 x 11	1291	1676	8 x 19	2000	2603
2 x 9	875	1136	4 x 10	1083	1406	6 x 12	1362	1770	8 x 20	2075	2697
2 x 10	947	1233	4 x 11	1153	1501	6 x 13	1434	1865			
2 x 11	1018	1325	4 x 12	1227	1595	6 x 14	1505	1958	9 x 9	1348	1754
2 x 12	1090	1418	4 x 13	1299	1688	6 x 15	1577	2051	9 x 10	1421	1847
2 x 13	1164	1510	4 x 14	1371	1783	6 x 16	1651	2144	9 x 11	1494	1940
2 x 14	1236	1605	4 x 15	1442	1874	6 x 17	1724	2242	9 x 12	1564	2035
2 x 15	1306	1700	4 x 16	1516	1969	6 x 18	1793	2334	9 x 13	1636	2127
2 x 16	1379	1793	4 x 17	1588	2064	6 x 19	1866	2426	9 x 14	1708	2221
2 x 17	1450	1886	4 x 18	1660	2156	6 x 20	1938	2519	9 x 15	1783	2314
2 x 18	1525	1982	4 x 19	1731	2250				9 x 16	1853	2410
2 x 19	1596	2075	4 x 20	1804	2342	7 x 7	1069	1390	9 x 17	1925	2504
2 x 20	1667	2168				7 x 8	1142	1482	9 x 18	1997	2596
			5 x 5	788	1026	7 x 9	1212	1577	9 x 19	2069	2689
3 x 3	511	662	5 x 6	860	1118	7 x 10	1285	1671	9 x 20	2142	2785
3 x 4	581	755	5 x 7	934	1213	7 x 11	1358	1763			
3 x 5	654	852	5 x 8	1006	1306	7 x 12	1430	1858	10 x 10	1488	1935
3 x 6	725	944	5 x 9	1077	1402	7 x 13	1501	1953	10 x 11	1560	2028
3 x 7	797	1038	5 x 10	1149	1495	7 x 14	1574	2047	10 x 12	1633	2123
3 x 8	871	1132	5 x 11	1221	1588	7 x 15	1647	2140	10 x 13	1703	2216
3 x 9	943	1224	5 x 12	1295	1683	7 x 16	1718	2231	10 x 14	1776	2309
3 x 10	1014	1319	5 x 13	1366	1776	7 x 17	1790	2326	10 x 15	1849	2404
3 x 11	1086	1413	5 x 14	1439	1869	7 x 18	1863	2420	10 x 16	1922	2497
3 x 12	1160	1505	5 x 15	1509	1962	7 x 19	1933	2515	10 x 17	1992	2590
3 x 13	1233	1601	5 x 16	1584	2055	7 x 20	2008	2608	10 x 18	2065	2684
3 x 14	1302	1693	5 x 17	1655	2152				10 x 19	2139	2777
3 x 15	1375	1788	5 x 18	1727	2246	8 x 8	1209	1570	10 x 20	2210	2873
3 x 16	1447	1882	5 x 19	1798	2338	8 x 9	1279	1665			
3 x 17	1520	1976	5 x 20	1870	2432	8 x 10	1351	1759			
3 x 18	1590	2068				8 x 11	1425	1853			
3 x 19	1664	2160				8 x 12	1498	1946			
3 x 20	1734	2256				8 x 13	1569	2040			

Kits Include:

- Mill Finish or Dk. Bronze
- Cut to size and mitered bodies
- Cut to size and mitered Lg Inner/Lg Outer Frame Retainers
- All screws required to assemble by mechanical fastening
- All Corner Angles and/or Corner Keys required
- Cut to size 2Part Large Hinge
- 2Part Large Lock(s)
- Packaging

Not Included in Kits:

- Faces or Back
- Electrical Components
- Ballast Pan(s) - See optional accessories
- Back Braces and Gussets
- Drilling of holes for lock(s)
- Attachment of lock(s) and hinge
- Raceway Covers and Cover Screws - See optional accessories
- Divider(s) - See optional accessories
- Gas Supports and Mounting Hardware - See optional accessories

Not Included in Kits:

- Mounting Provisions

Optional Accessories (pgs 182-183):

- Ballast Pan(s)
- Raceway Covers and Cover Screws
- Divider(s)
- Gas Supports with Mounting Hardware (Call Customer Service for size and price)

Kit Specifications:

- It is recommended to order kits 1-3/4" over nominal T12 or T8 lamp size to utilize .040 flat Aluminum Raceway Covers
- Custom size kits may be cut to any dimension

Recommended Lamp Spacing:

- For illuminated backgrounds - 6" on center, using T12 or T8 lamps
- Always place lamps 3/4" from back of sign

Divider Kits Include:

- Cut to size dividers
- Divider Corner Angles and/or Corner Keys
- All screws required to assemble by mechanical fastening
- 2Part Divider, Part #1905, Mill Finish \$5.94 and Dk. Bronze \$7.71 per/ft per/face
- Large Header/Reader, Mill Finish \$25.98 and Dk. Bronze \$33.75 per/ft per/face (Includes 2Part Large Hinge)
- Large Vandal/Vandal, Mill Finish \$75.72 and Dk. Bronze \$98.48 per/ft per/face (Includes 2Part Large Hinge)

Additional Information (pgs 196-197)

Note: It is recommended to use safety chains and prop-bars on all hingeable faces.

Unassembled Single Face Kits - For Vandal Retainers

2Part 8" S/F Body w/ 2Part Large Inner Frame and 2Part Large Outer Frame

Part #1927
K1927/59/41

Part #1959

Part #1941

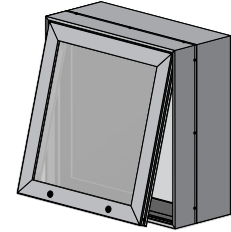
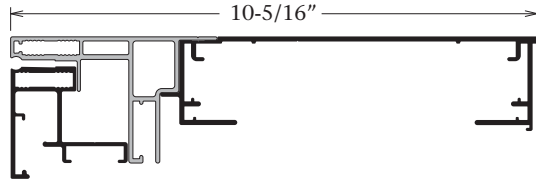

Size H'xW'	Mill Finish	Dk. Bronze	Size H'xW'	Mill Finish	Dk. Bronze	Size H'xW'	Mill Finish	Dk. Bronze	Size H'xW'	Mill Finish	Dk. Bronze
2 x 3	\$478	\$618	4 x 4	\$702	\$912	6 x 6	\$1006	\$1304	8 x 14	\$1775	\$2307
2 x 4	554	721	4 x 5	780	1013	6 x 7	1083	1406	8 x 15	1853	2409
2 x 5	631	823	4 x 6	857	1114	6 x 8	1161	1507	8 x 16	1930	2509
2 x 6	710	923	4 x 7	935	1216	6 x 9	1239	1608	8 x 17	2009	2611
2 x 7	788	1025	4 x 8	1013	1316	6 x 10	1316	1709	8 x 18	2087	2712
2 x 8	867	1128	4 x 9	1090	1418	6 x 11	1394	1814	8 x 19	2164	2813
2 x 9	944	1228	4 x 10	1170	1522	6 x 12	1471	1913	8 x 20	2243	2915
2 x 10	1021	1328	4 x 11	1247	1621	6 x 13	1550	2016	9 x 9	1458	1895
2 x 11	1100	1431	4 x 12	1325	1724	6 x 14	1627	2115	9 x 10	1534	1997
2 x 12	1177	1530	4 x 13	1403	1822	6 x 15	1705	2218	9 x 11	1612	2097
2 x 13	1257	1633	4 x 14	1479	1925	6 x 16	1784	2317	9 x 12	1692	2199
2 x 14	1332	1732	4 x 15	1558	2024	6 x 17	1862	2419	9 x 13	1768	2302
2 x 15	1410	1835	4 x 16	1636	2127	6 x 18	1938	2519	9 x 14	1847	2402
2 x 16	1491	1935	4 x 17	1714	2227	6 x 19	2017	2622	9 x 15	1925	2504
2 x 17	1565	2037	4 x 18	1791	2329	6 x 20	2095	2725	9 x 16	2001	2604
2 x 18	1644	2140	4 x 19	1869	2432	7 x 7	1156	1502	9 x 17	2080	2707
2 x 19	1724	2242	4 x 20	1948	2533	7 x 8	1235	1604	9 x 18	2159	2806
2 x 20	1799	2341				7 x 9	1311	1705	9 x 19	2238	2908
			5 x 5	853	1109	7 x 10	1390	1806	9 x 20	2314	3008
3 x 3	550	716	5 x 6	931	1211	7 x 11	1467	1907	10 x 10	1609	2093
3 x 4	627	816	5 x 7	1009	1311	7 x 12	1545	2009	10 x 11	1688	2194
3 x 5	705	918	5 x 8	1086	1413	7 x 13	1623	2109	10 x 12	1764	2295
3 x 6	783	1018	5 x 9	1164	1513	7 x 14	1700	2211	10 x 13	1844	2397
3 x 7	860	1120	5 x 10	1241	1616	7 x 15	1779	2311	10 x 14	1922	2497
3 x 8	939	1220	5 x 11	1319	1716	7 x 16	1855	2414	10 x 15	1998	2599
3 x 9	1015	1324	5 x 12	1397	1818	7 x 17	1935	2515	10 x 16	2077	2701
3 x 10	1095	1423	5 x 13	1474	1919	7 x 18	2014	2616	10 x 17	2155	2801
3 x 11	1173	1526	5 x 14	1554	2020	7 x 19	2092	2717	10 x 18	2231	2903
3 x 12	1249	1625	5 x 15	1633	2123	7 x 20	2168	2819	10 x 19	2310	3003
3 x 13	1328	1728	5 x 16	1709	2222	8 x 8	1306	1699	10 x 20	2388	3105
3 x 14	1407	1830	5 x 17	1788	2325	8 x 9	1384	1799			
3 x 15	1486	1930	5 x 18	1866	2425	8 x 10	1465	1900			
3 x 16	1562	2032	5 x 19	1944	2527	8 x 11	1540	2001			
3 x 17	1640	2131	5 x 20	2021	2627	8 x 12	1620	2105			
3 x 18	1719	2235				8 x 13	1697	2206			
3 x 19	1795	2335									
3 x 20	1874	2437									

Kits Include:

- Mill Finish or Dk. Bronze
- Cut to size and mitered bodies
- Cut to size and mitered Lg Inner/Lg Outer Frame Retainers
- All screws required to assemble by mechanical fastening
- All Corner Angles and/or Corner Keys required
- Cut to size 2Part Large Hinges
- 2Part Large Lock(s)
- Packaging

Not Included in Kits:

- Faces or Back
- Electrical Components
- Ballast Pan(s) - See optional accessories
- Back Braces and Gussets
- Drilling of holes for lock(s)
- Attachment of lock(s) and hinge
- Raceway Covers and Cover Screws - See optional accessories
- Divider(s) - See optional accessories
- Gas Supports and Mounting Hardware - See optional accessories

Not Included in Kits:

- Mounting Provisions

Optional Accessories (pgs 182-183):

- Ballast Pan(s)
- Raceway Covers and Cover Screws
- Divider(s)
- Gas Supports with Mounting Hardware (Call Customer Service for size and price)

Kit Specifications:

- It is recommended to order kits 1-3/4" over nominal T12 or T8 lamp size to utilize .040 flat Aluminum Raceway Covers
 - Custom size kits may be cut to any dimension
- #### Recommended Lamp Spacing:
- For illuminated backgrounds - 10" on center, using T12 or T8 lamps
 - Always place lamps 3/4" from back of sign

Divider Kits Include:

- Cut to size dividers
- Divider Corner Angles and/or Corner Keys
- All screws required to assemble by mechanical fastening
- **2Part Divider, Part #1905**, Mill Finish \$5.94 and Dk. Bronze \$7.71 per/ft per/face
- **Large Header/Reader**, Mill Finish \$25.98 and Dk. Bronze \$33.75 per/ft per/face (Includes 2Part Large Hinge)
- **Large Vandal/Vandal**, Mill Finish \$75.72 and Dk. Bronze \$98.48 per/ft per/face (Includes 2Part Large Hinge)

Additional Information (pgs 196-197)

Note: It is recommended to use safety chains and prop-bars on all hingeable faces.

Note: All dimensions are subject to the tolerance standards of the aluminum extrusion industry. Profile drawings are illustrative and rounded to the nearest 1/16".

CURRENT PRICE as of April 1, 2022



Unassembled Double Face Kits - For Vandal Retainers

2Part 6" D/F Body w/ 2Part Large Inner Frame and 2Part Large Outer Frame

Part #1936
K1936/59/41

Part #1959

Part #1941

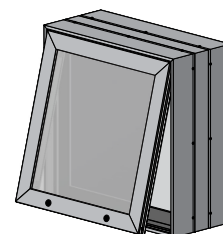
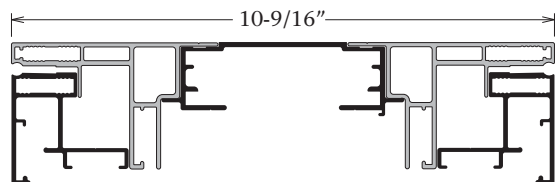

Size H'xW'	Mill Finish	Dk. Bronze	Size H'xW'	Mill Finish	Dk. Bronze	Size H'xW'	Mill Finish	Dk. Bronze	Size H'xW'	Mill Finish	Dk. Bronze
2 x 3	\$682	\$885	4 x 4	\$1006	\$1306	6 x 6	\$1442	\$1874	8 x 14	\$2559	\$3327
2 x 4	796	1034	4 x 5	1118	1454	6 x 7	1557	2021	8 x 15	2674	3475
2 x 5	908	1181	4 x 6	1233	1602	6 x 8	1668	2171	8 x 16	2786	3622
2 x 6	1021	1328	4 x 7	1346	1751	6 x 9	1784	2317	8 x 17	2901	3772
2 x 7	1134	1474	4 x 8	1458	1895	6 x 10	1895	2465	8 x 18	3012	3917
2 x 8	1248	1623	4 x 9	1573	2045	6 x 11	2012	2612	8 x 19	3127	4065
2 x 9	1362	1768	4 x 10	1684	2191	6 x 12	2123	2761	8 x 20	3238	4212
2 x 10	1474	1916	4 x 11	1798	2338	6 x 13	2237	2907	9 x 9	2097	2729
2 x 11	1588	2065	4 x 12	1911	2485	6 x 14	2349	3055	9 x 10	2212	2875
2 x 12	1702	2212	4 x 13	2024	2633	6 x 15	2461	3201	9 x 11	2325	3024
2 x 13	1815	2358	4 x 14	2140	2780	6 x 16	2574	3348	9 x 12	2440	3169
2 x 14	1928	2507	4 x 15	2251	2929	6 x 17	2689	3495	9 x 13	2552	3317
2 x 15	2042	2651	4 x 16	2366	3075	6 x 18	2801	3644	9 x 14	2665	3464
2 x 16	2155	2801	4 x 17	2479	3222	6 x 19	2916	3791	9 x 15	2777	3610
2 x 17	2269	2948	4 x 18	2592	3368	6 x 20	3028	3939	9 x 16	2892	3759
2 x 18	2382	3096	4 x 19	2705	3517	7 x 7	1661	2159	9 x 17	3006	3908
2 x 19	2493	3242	4 x 20	2819	3664	7 x 8	1775	2307	9 x 18	3118	4054
2 x 20	2608	3391				7 x 9	1890	2454	9 x 19	3232	4201
			5 x 5	1224	1590	7 x 10	2000	2600	9 x 20	3345	4347
3 x 3	785	1021	5 x 6	1336	1737	7 x 11	2115	2747	10 x 10	2317	3012
3 x 4	900	1172	5 x 7	1450	1885	7 x 12	2227	2898	10 x 11	2429	3161
3 x 5	1013	1318	5 x 8	1562	2035	7 x 13	2341	3044	10 x 12	2543	3307
3 x 6	1128	1466	5 x 9	1677	2182	7 x 14	2454	3191	10 x 13	2656	3454
3 x 7	1240	1611	5 x 10	1790	2328	7 x 15	2568	3337	10 x 14	2770	3601
3 x 8	1355	1759	5 x 11	1905	2476	7 x 16	2681	3486	10 x 15	2882	3749
3 x 9	1467	1906	5 x 12	2017	2622	7 x 17	2796	3631	10 x 16	2998	3895
3 x 10	1580	2053	5 x 13	2130	2769	7 x 18	2907	3780	10 x 17	3109	4042
3 x 11	1693	2200	5 x 14	2244	2917	7 x 19	3023	3927	10 x 18	3225	4189
3 x 12	1807	2349	5 x 15	2357	3063	7 x 20	3134	4073	10 x 19	3336	4336
3 x 13	1921	2496	5 x 16	2470	3210	8 x 8	1881	2444	10 x 20	3451	4484
3 x 14	2035	2643	5 x 17	2584	3360	8 x 9	1992	2590			
3 x 15	2146	2793	5 x 18	2699	3505	8 x 10	2107	2738			
3 x 16	2259	2937	5 x 19	2812	3654	8 x 11	2219	2885			
3 x 17	2373	3086	5 x 20	2924	3803	8 x 12	2334	3033			
3 x 18	2487	3232				8 x 13	2448	3180			
3 x 19	2599	3380									
3 x 20	2714	3526									

Kits Include:

- Mill Finish or Dk. Bronze
- Cut to size and mitered bodies
- Cut to size and mitered Lg Inner/Lg Outer Frame Retainers
- All screws required to assemble by mechanical fastening
- All Corner Angles and/or Corner Keys required
- Cut to size 2Part Large Hinges
- 2Part Large Lock(s)
- Packaging

Not Included in Kits:

- Faces
- Electrical Components
- Internal Supports
- Drilling of holes for lock(s)
- Attachment of lock(s) and hinge
- Divider(s) - See optional accessories
- Gas Supports and Mounting Hardware - See optional accessories

Optional Accessories (pg 182):

- Divider(s)
- Gas Supports with Mounting Hardware (Call Customer Service for size and price)

Kit Specifications:

- It is recommended to order kits 1" over nominal T12 or T8 lamp size to utilize .040 flat Aluminum Raceway Covers
- Custom size kits may be cut to any dimension

Recommended Lamp Spacing:

- For illuminated backgrounds - 10" on center, using T12 or T8 lamps

Divider Kits Include:

- Cut to size dividers
- Divider Corner Angles and/or Corner Keys
- All screws required to assemble by mechanical fastening
- 2Part Divider, Part #1905, Mill Finish \$5.94 and Dk. Bronze \$7.71 per/ft per/face
- Large Header/Reader, Mill Finish \$25.98 and Dk. Bronze \$33.75 per/ft per/face (Includes 2Part Large Hinge)
- Large Vandal/Vandal, Mill Finish \$75.72 and Dk. Bronze \$98.48 per/ft per/face (Includes 2Part Large Hinge)

Additional Information (pgs 196-197)

Note: It is recommended to use safety chains and prop-bars on all hingeable faces.

Note: All dimensions are subject to the tolerance standards of the aluminum extrusion industry. Profile drawings are illustrative and rounded to the nearest 1/16".

**CURRENT PRICE as
of April 1, 2022**



Unassembled Double Face Kits - For Vandal Retainers

2Part 12" D/F Body w/ 2Part Large Inner Frame and 2Part Large Outer Frame

Part #1929
K1929/59/41

Part #1959

Part #1941

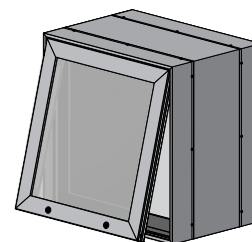
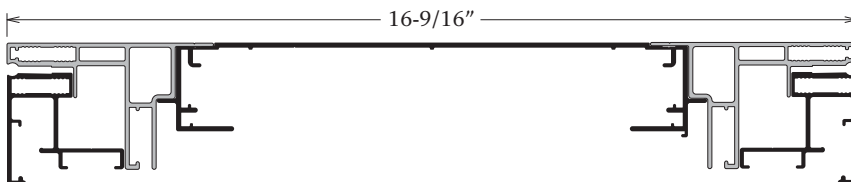

Size H'xW'	Mill Finish	Dk. Bronze	Size H'xW'	Mill Finish	Dk. Bronze	Size H'xW'	Mill Finish	Dk. Bronze	Size H'xW'	Mill Finish	Dk. Bronze
2 x 3	\$807	\$1045	4 x 4	\$1184	\$1540	6 x 6	\$1697	\$2206	8 x 14	\$3002	\$3903
2 x 4	938	1218	4 x 5	1318	1711	6 x 7	1830	2380	8 x 15	3135	4076
2 x 5	1070	1393	4 x 6	1449	1885	6 x 8	1961	2548	8 x 16	3266	4247
2 x 6	1202	1562	4 x 7	1584	2055	6 x 9	2095	2721	8 x 17	3399	4420
2 x 7	1335	1736	4 x 8	1714	2228	6 x 10	2226	2895	8 x 18	3533	4591
2 x 8	1469	1907	4 x 9	1847	2401	6 x 11	2358	3066	8 x 19	3664	4765
2 x 9	1601	2080	4 x 10	1980	2572	6 x 12	2489	3238	8 x 20	3799	4936
2 x 10	1732	2251	4 x 11	2112	2745	6 x 13	2623	3411	9 x 9	2465	3203
2 x 11	1865	2425	4 x 12	2246	2917	6 x 14	2758	3582	9 x 10	2598	3375
2 x 12	1997	2596	4 x 13	2376	3089	6 x 15	2889	3755	9 x 11	2730	3549
2 x 13	2128	2769	4 x 14	2509	3261	6 x 16	3023	3927	9 x 12	2863	3720
2 x 14	2261	2940	4 x 15	2642	3434	6 x 17	3153	4099	9 x 13	2995	3892
2 x 15	2393	3113	4 x 16	2773	3606	6 x 18	3287	4271	9 x 14	3127	4065
2 x 16	2527	3285	4 x 17	2905	3779	6 x 19	3419	4443	9 x 15	3259	4238
2 x 17	2661	3458	4 x 18	3038	3950	6 x 20	3550	4615	9 x 16	3392	4408
2 x 18	2793	3628	4 x 19	3170	4122	7 x 7	1953	2539	9 x 17	3522	4581
2 x 19	2924	3803	4 x 20	3304	4295	7 x 8	2087	2710	9 x 18	3656	4754
2 x 20	3056	3973				7 x 9	2218	2882	9 x 19	3788	4925
			5 x 5	1441	1871	7 x 10	2351	3055	9 x 20	3919	5096
3 x 3	928	1208	5 x 6	1574	2047	7 x 11	2481	3228	10 x 10	2719	3537
3 x 4	1063	1379	5 x 7	1705	2218	7 x 12	2615	3398	10 x 11	2853	3709
3 x 5	1193	1553	5 x 8	1838	2389	7 x 13	2746	3571	10 x 12	2986	3882
3 x 6	1327	1725	5 x 9	1969	2563	7 x 14	2879	3744	10 x 13	3118	4052
3 x 7	1458	1895	5 x 10	2103	2735	7 x 15	3012	3915	10 x 14	3252	4227
3 x 8	1590	2068	5 x 11	2235	2905	7 x 16	3143	4087	10 x 15	3383	4398
3 x 9	1725	2242	5 x 12	2368	3078	7 x 17	3277	4262	10 x 16	3515	4569
3 x 10	1855	2413	5 x 13	2503	3252	7 x 18	3408	4433	10 x 17	3649	4742
3 x 11	1989	2586	5 x 14	2633	3423	7 x 19	3543	4604	10 x 18	3779	4913
3 x 12	2121	2758	5 x 15	2766	3594	7 x 20	3673	4775	10 x 19	3913	5086
3 x 13	2253	2931	5 x 16	2898	3766	8 x 8	2210	2872	10 x 20	4045	5257
3 x 14	2385	3102	5 x 17	3030	3939	8 x 9	2341	3044			
3 x 15	2517	3273	5 x 18	3162	4112	8 x 10	2475	3216			
3 x 16	2649	3446	5 x 19	3293	4282	8 x 11	2607	3389			
3 x 17	2782	3620	5 x 20	3426	4457	8 x 12	2738	3558			
3 x 18	2916	3788				8 x 13	2872	3731			
3 x 19	3047	3961									
3 x 20	3180	4133									

Kits Include:

- Mill Finish or Dk. Bronze
- Cut to size and mitered bodies
- Cut to size and mitered Lg Inner/Lg Outer Frame Retainers
- All screws required to assemble by mechanical fastening
- All Corner Angles and/or Corner Keys required
- Cut to size 2Part Large Hinges
- 2Part Large Lock(s)
- Packaging

Not Included in Kits:

- Faces
- Electrical Components
- Ballast Pan(s) - See optional accessories
- Internal Supports
- Drilling of holes for lock(s)
- Attachment of lock(s) and hinge
- Raceway Covers and Cover Screws - See optional accessories
- Divider(s) - See optional accessories
- Gas Supports and Mounting Hardware - See optional accessories

Optional Accessories (pgs 182-183):

- Ballast Pan(s)
- Raceway Covers and Cover Screws
- Divider(s)
- Gas Supports with Mounting Hardware (Call Customer Service for size and price)

Kit Specifications:

- It is recommended to order kits 1-3/4" over nominal T12 or T8 lamp size to utilize .040 flat Aluminum Raceway Covers
- Custom size kits may be cut to any dimension

Recommended Lamp Spacing:

- For illuminated backgrounds - 9" on center, using T12 or T8 lamps

Divider Kits Include:

- Cut to size dividers
- Divider Corner Angles and/or Corner Keys
- All screws required to assemble by mechanical fastening
- 2Part Divider, Part #1905, Mill Finish \$5.94 and Dk. Bronze \$7.71 per/ft per/face
- Large Header/Reader, Mill Finish \$25.98 and Dk. Bronze \$33.75 per/ft per/face (Includes 2Part Large Hinge)
- Large Vandal/Vandal, Mill Finish \$75.72 and Dk. Bronze \$98.48 per/ft per/face (Includes 2Part Large Hinge)

Additional Information (pgs 196-197)

Note: It is recommended to use safety chains and prop-bars on all hingeable faces.

Standard System Optional Accessories

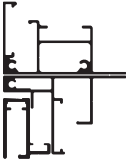
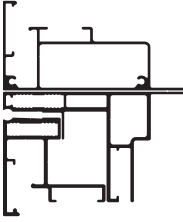
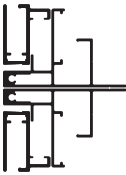
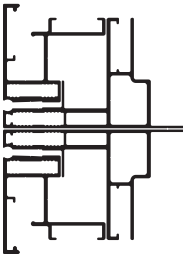
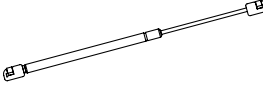
Dividers		Part Number	Cost Per/Ft Mill Finish	Cost Per/Ft Dk. Bronze
Cut To Size Dividers				
For Rigid Plastic Faces				
	2Part Divider Included: <ul style="list-style-type: none"> Screws for mechanical fastening Divider Angles 	K1905	\$5.94	\$7.71
	2Part Extended Retainer 2Part Vandal System Included: <ul style="list-style-type: none"> Screws for mechanical fastening Divider Angles 2" x 2" x 1/8" (3/4") Corner Angles and Corner Keys 2Part Hinge 	1940 & 1942/1960	14.53	18.90
	2Part Large Extended Retainer 2Part Large Vandal System Included: <ul style="list-style-type: none"> Screws for mechanical fastening Divider Angles 2" x 2" x 1/8" (3/4") Corner Angles and Corner Keys 2Part Large Hinge 	1939 & 1941/1959	25.98	33.75
	2Part Vandal System 2Part Vandal System Included: <ul style="list-style-type: none"> Screws for mechanical fastening Divider Angles 2" x 2" x 1/8" (3/4") Corner Angles and Corner Keys 2Part Hinge 	1942/1960 & 1942/1960	32.16	41.84
	2Part Large Vandal System 2Part Large Vandal System Included: <ul style="list-style-type: none"> Screws for mechanical fastening Divider Angles 2" x 2" x 1/8" (3/4") Corner Angles and Corner Keys 2Part Large Hinge 	1941/1959 & 1941/1959	75.72	98.48
Components		Part Number	Price Each	
Gas Supports				
	Gas Support Included: <ul style="list-style-type: none"> Two (2) Gas Supports Two (2) Ball Stud Mounting Brackets Four (4) 10mm Ball Studs Screws for mechanical fastening Designed for SignComp Large Vandal only. Not recommended with other systems. Call Customer Service for specific gas support size and poundage.	K5934	\$87.23	

S T A N D A R D

Note: All dimensions are subject to the tolerance standards of the aluminum extrusion industry. Profile drawings are illustrative and rounded to the nearest 1/16".

CURRENT PRICE as of April 1, 2022



Standard System Optional Accessories

Components	Part	Part Number	Price Each
Raceway Covers			
	1Part 2Part 12" D/F Body Raceway Cover 9-7/8" x 48" x .040 (white) Pre-Punched 12" O/C	5984-12"	\$28.09
	1Part 2Part 12" D/F Body Raceway Cover 9-7/8" x 36" x .040 (white) Pre-Punched 12" O/C	5983-12"	24.62
	1Part 2Part 12" D/F Body Raceway Cover 9-7/8" x 24" x .040 (white) Pre-Punched 12" O/C	5982-12"	18.49
	1Part 2Part 9" D/F Body Raceway Cover 6-7/8" x 48" x .040 (white) Pre-Punched 12" O/C	5984-9"	22.19
	1Part 2Part 9" D/F Body Raceway Cover 6-7/8" x 36" x .040 (white) Pre-Punched 12" O/C	5983-9"	20.43
	1Part 2Part 9" D/F Body Raceway Cover 6-7/8" x 24" x .040 (white) Pre-Punched 12" O/C	5982-9"	15.55
	1Part 2Part 8" S/F Body Raceway Cover 6-1/2" x 48" x .040 (white) Pre-Punched 12" O/C	5984-8"	21.25
	1Part 2Part 8" S/F Body Raceway Cover 6-1/2" x 36" x .040 (white) Pre-Punched 12" O/C	5983-8"	19.69
	1Part 2Part 8" S/F Body Raceway Cover 6-1/2" x 24" x .040 (white) Pre-Punched 12" O/C	5982-8"	15.05
	1Part 2Part 6" S/F Body Raceway Cover 4-3/4" x 48" x .040 (white) Pre-Punched 12" O/C	5984-6"	17.99
	1Part 2Part 6" S/F Body Raceway Cover 4-3/4" x 36" x .040 (white) Pre-Punched 12" O/C	5983-6"	16.80
	1Part 2Part 6" S/F Body Raceway Cover 4-3/4" x 24" x .040 (white) Pre-Punched 12" O/C	5982-6"	13.50
	1Part 2Part 12" D/F Body Raceway Cover 9-7/8" x 48" x .040 (white) Blank	5984B-12"	23.47
	1Part 2Part 9" D/F Body Raceway Cover 6-7/8" x 48" x .040 (white) Blank	5984B-9"	15.89
	1Part 2Part 8" S/F Body Raceway Cover 6-1/2" x 48" x .040 (white) Blank	5984B-8"	14.57
	1Part 2Part 6" S/F Body Raceway Cover 4-3/4" x 48" x .040 (white) Blank	5984B-6"	11.72
Ballast Pans			
	1Part 2Part 12" D/F Body Ballast Pan 7-1/2" x 24" x .063	5970	29.62
	1Part 2Part 9" D/F Body Ballast Pan 4-5/8" x 24" x .063	5971	23.15
	1Part 2Part 6" S/F Body Ballast Pan 3-1/2" x 24" x .063	5969	20.52

Edge Lit LED 1/2 Round

Part #1995
K1995

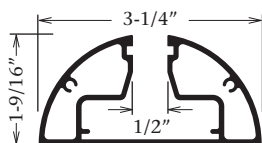

Length Inches	Mill Finish
12	\$95
15	96
18	98
24	100
30	104
36	107
42	108
48	111
54	118
60	120
66	123
72	127

Kits Include:

- Mill Finish
- One (1) piece cut to size
- Two (2) End Caps and screws
- All spring pins required for assembly

Not Included in Kits:

- Face
- LED's
- Electrical Components

Edge Lit LED 1/4 Round

Part #1996
K1996

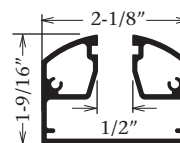

Length Inches	Mill Finish
12	\$90
15	95
18	96
24	98
30	100
36	104
42	106
48	108
54	111
60	114
66	119
72	122

Kits Include:

- Mill Finish
- One (1) piece cut to size
- Two (2) End Caps and screws
- All spring pins required for assembly

Not Included in Kits:

- Face
- LED's
- Electrical Components

Unassembled Snap Frame Kits - For Rigid Faces

Snap Frames

Part #1899

Flat and Radius Cover

Part #1895 Part #1896
K1899/95 K1899/96

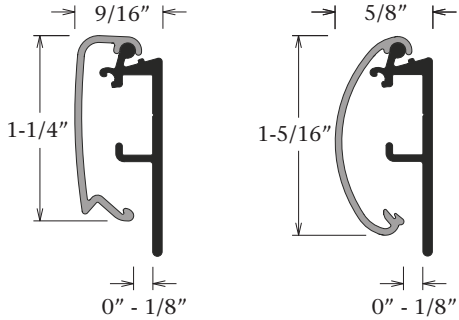

Large Snap Frames

Part #1898

Flat and Radius Cover

Part #1895 Part #1896
K1898/95 K1898/96

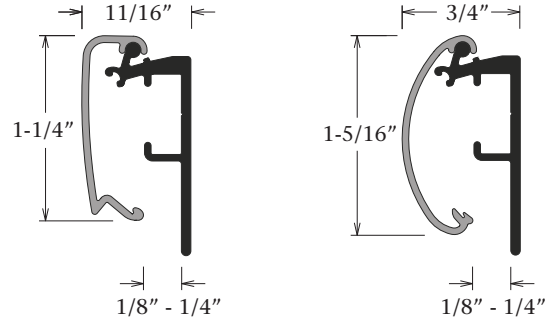

Size H"xW"	Mill Finish	Size H"xW"	Mill Finish	Size H"xW"	Mill Finish	Size H"xW"	Clear Anodized Finish	Size H"xW"	Clear Anodized Finish	Size H"xW"	Clear Anodized Finish
12 x 12	\$27	24 x 24	\$45	36 x 36	\$62	12 x 12	\$31	24 x 24	\$55	36 x 36	\$76
12 x 18	31	24 x 30	50	36 x 48	71	12 x 18	35	24 x 30	59	36 x 48	88
12 x 24	34	24 x 36	55	36 x 60	79	12 x 24	44	24 x 36	66	36 x 60	98
12 x 30	40	24 x 48	62	36 x 72	90	12 x 30	50	24 x 48	76	36 x 72	110
12 x 36	45	24 x 60	71	36 x 84	98	12 x 36	55	24 x 60	88	36 x 84	122
12 x 48	55	24 x 72	79	36 x 96	107	12 x 48	66	24 x 72	98	36 x 96	134
12 x 60	62	24 x 84	90	36 x 108	118	12 x 60	76	24 x 84	110	36 x 108	143
12 x 72	71	24 x 96	98	36 x 120	124	12 x 72	88	24 x 96	122	36 x 120	155
12 x 84	79	24 x 108	107	36 x 132	135	12 x 84	98	24 x 108	134	36 x 132	167
12 x 96	90	24 x 120	118	36 x 144	143	12 x 96	110	24 x 120	143	36 x 144	178
12 x 108	98	24 x 132	124			12 x 108	122	24 x 132	155		
12 x 120	107	24 x 144	135	48 x 48	79	12 x 120	134	24 x 144	167	48 x 48	98
12 x 132	118			48 x 60	90	12 x 132	143			48 x 60	110
12 x 144	124	30 x 30	55	48 x 72	98	12 x 144	155	30 x 30	66	48 x 72	122
		30 x 36	57	48 x 84	107			30 x 36	71	48 x 84	134
		30 x 48	67	48 x 96	118	18 x 18	44	30 x 48	82	48 x 96	143
18 x 18	34	30 x 60	76	48 x 108	124	18 x 24	50	30 x 60	94	48 x 108	155
18 x 24	40	30 x 72	85	48 x 120	135	18 x 30	55	30 x 72	106	48 x 120	167
18 x 30	45	30 x 84	94	48 x 132	143	18 x 36	59	30 x 84	118	48 x 132	178
18 x 36	50	30 x 96	103	48 x 144	152	18 x 48	71	30 x 96	127	48 x 144	190
18 x 48	57	30 x 108	111			18 x 60	82	30 x 108	138		
18 x 60	67	30 x 120	122	60 x 60	98	18 x 72	94	30 x 120	151	60 x 60	122
18 x 72	76	30 x 132	131	60 x 72	107	18 x 84	106	30 x 132	162	60 x 72	134
18 x 84	85	30 x 144	138	60 x 84	118	18 x 96	118	30 x 144	173	60 x 84	143
18 x 96	94			60 x 96	124	18 x 108	127			60 x 96	155
18 x 108	103			60 x 108	135	18 x 120	138			60 x 108	167
18 x 120	111			60 x 120	143	18 x 132	151			60 x 120	178
18 x 132	122			60 x 132	152	18 x 144	162			60 x 132	190
18 x 144	131			60 x 144	162					60 x 144	201

Kits Include:

- Mill Finish Frames
- Mill Finish or Clear Anodized covers
- Cut to size and mitered frames and covers
- Snap Frame Springs
- All 2 Piece Corner Keys required
- Packaging

Not Included in Kits:

- Face or Back
- Mounting Provisions

Kit Specifications:

- Custom size kits may be cut to any dimension

Additional Information (pgs 196-197)

Note: All dimensions are subject to the tolerance standards of the aluminum extrusion industry. Profile drawings are illustrative and rounded to the nearest 1/16".

CURRENT PRICE as of April 1, 2022



Unassembled Wall Frames Kits - For Rigid Faces

3/4" Wall Frame

Part #1948
K1948

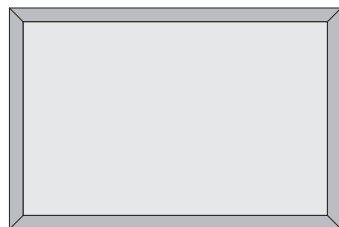
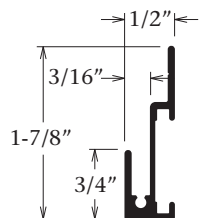

1-3/8" Wall Frame

Part #1949
K1949

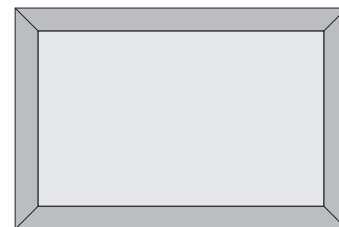
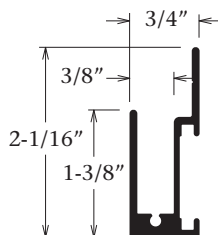

Size H"xW"	Clear Anodized Finish	Size H"xW"	Clear Anodized Finish	Size H"xW"	Clear Anodized Finish	Size H"xW"	Clear Anodized Finish	Size H"xW"	Clear Anodized Finish	Size H"xW"	Clear Anodized Finish
12 x 12	\$50	24 x 24	\$63	36 x 36	\$78	12 x 12	\$52	24 x 24	\$71	36 x 36	\$90
12 x 18	52	24 x 30	67	36 x 48	85	12 x 18	57	24 x 30	76	36 x 48	98
12 x 24	56	24 x 36	71	36 x 60	92	12 x 24	62	24 x 36	80	36 x 60	107
12 x 30	60	24 x 48	78	36 x 72	100	12 x 30	66	24 x 48	90	36 x 72	116
12 x 36	63	24 x 60	85	36 x 84	107	12 x 36	71	24 x 60	98	36 x 84	124
12 x 48	71	24 x 72	92	36 x 96	118	12 x 48	80	24 x 72	107	36 x 96	135
12 x 60	78	24 x 84	100	36 x 108	120	12 x 60	90	24 x 84	116	36 x 108	143
12 x 72	85	24 x 96	107	36 x 120	127	12 x 72	98	24 x 96	124	36 x 120	152
12 x 84	92	24 x 108	114	36 x 132	135	12 x 84	107	24 x 108	135	36 x 132	162
12 x 96	100	24 x 120	120	36 x 144	142	12 x 96	116	24 x 120	143	36 x 144	170
12 x 108	107	24 x 132	127			12 x 108	124	24 x 132	152		
12 x 120	114	24 x 144	135	48 x 48	92	12 x 120	135	24 x 144	162	48 x 48	107
12 x 132	120			48 x 60	100	12 x 132	143			48 x 60	116
12 x 144	127			48 x 72	107	12 x 144	152			48 x 72	124
		30 x 30	71	48 x 84	114			30 x 30	80	48 x 84	135
		30 x 36	75	48 x 96	120			30 x 36	85	48 x 96	143
18 x 18	56	30 x 48	82	48 x 108	127	18 x 18	62	30 x 48	94	48 x 108	152
18 x 24	60	30 x 60	88	48 x 120	135	18 x 24	66	30 x 60	103	48 x 120	162
18 x 30	63	30 x 72	95	48 x 132	142	18 x 30	71	30 x 72	111	48 x 132	170
18 x 36	67	30 x 84	103	48 x 144	150	18 x 36	76	30 x 84	120	48 x 144	179
18 x 48	75	30 x 96	110			18 x 48	85	30 x 96	129		
18 x 60	82	30 x 108	118			18 x 60	94	30 x 108	139		
18 x 72	88	30 x 120	124	60 x 60	107	18 x 72	103	30 x 120	148	60 x 60	124
18 x 84	95	30 x 132	132	60 x 72	114	18 x 84	111	30 x 132	157	60 x 72	135
18 x 96	103	30 x 144	139	60 x 84	120	18 x 96	120	30 x 144	166	60 x 84	143
18 x 108	110			60 x 96	127	18 x 108	129			60 x 96	152
18 x 120	118			60 x 108	135	18 x 120	139			60 x 108	162
18 x 132	124			60 x 120	142	18 x 132	148			60 x 120	170
18 x 144	132			60 x 132	150	18 x 144	157			60 x 132	179
				60 x 144	157					60 x 144	189

Kits Include:

- Clear Anodized Finish
- Cut to size and mitered frames
- Verticals are pre-drilled and countersunk
- All screws required to assemble by mechanical fastening
- All Corner Keys required
- Packaging

Not Included in Kits:





- Face
- Mounting Provisions

Kit Specifications:

- Custom size kits may be cut to any dimension

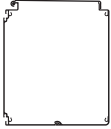
Additional Information (pgs 196-197)

Unassembled Channel Letter Raceways

Bundles	Part	Part Number	Length	Unit Price
8"	 <p>2 Piece 8" Channel Letter Raceway</p> <ul style="list-style-type: none"> • One (1) 2 Piece 8" Channel Letter Raceway - Front • One (1) 2 Piece 8" Channel Letter Raceway - Back • One (1) 8" Channel Letter Raceway Cover <p>Not Included: Hardware, Brace/Brackets, Mounting Clips or End Caps</p>	B1982	24'-2"	\$560.23 <i>Cost per Foot 23.18</i>
	 <p>2 Piece 8" Narrow Channel Letter Raceway</p> <ul style="list-style-type: none"> • One (1) 2 Piece 8" Channel Letter Raceway - Front • One (1) 2 Piece 8" Narrow Channel Letter Raceway - Back • One (1) 8" Narrow Channel Letter Raceway Cover <p>Not Included: Hardware, Brace/Brackets, Mounting Clips or End Caps</p>	B1982N	24'-2"	479.99 <i>Cost per Foot 19.86</i>
5"	 <p>2 Piece 5" Channel Letter Raceway</p> <ul style="list-style-type: none"> • One (1) 2 Piece 5" Channel Letter Raceway - Front • One (1) 2 Piece 5" Channel Letter Raceway - Back • One (1) 5" Channel Letter Raceway Cover <p>Not Included: Hardware, Brace/Brackets, Mounting Clips or End Caps</p>	B1972	24'-2"	358.32 <i>Cost per Foot 14.83</i>
	 <p>2 Piece 5" Narrow Channel Letter Raceway</p> <ul style="list-style-type: none"> • One (1) 2 Piece 5" Channel Letter Raceway - Front • One (1) 2 Piece 5" Narrow Channel Letter Raceway - Back • One (1) 5" Narrow Channel Letter Raceway Cover <p>Not Included: Hardware, Brace/Brackets, Mounting Clips or End Caps</p>	B1972N	24'-2"	308.33 <i>Cost per Foot 12.76</i>
	 <p>1 Piece 5" Narrow Channel Letter Raceway</p> <ul style="list-style-type: none"> • One (1) 1 Piece 5" Narrow Channel Letter Raceway • One (1) 5" Narrow Channel Letter Raceway Cover <p>Not Included: Hardware, Brace/Brackets, Mounting Clips or End Caps</p>	B1970N	24'-2"	313.71 <i>Cost per Foot 12.98</i>

Channel Letter Raceway Splicing Guidelines

- Cut two 6" Channel Letter Raceway Brace/Brackets
- Insert into the top and bottom of one section of raceway

- Connect both sections of raceway together by sliding the brace/brackets into the second piece of raceway
- Weld or bond both sides of the top and bottom to secure the splice

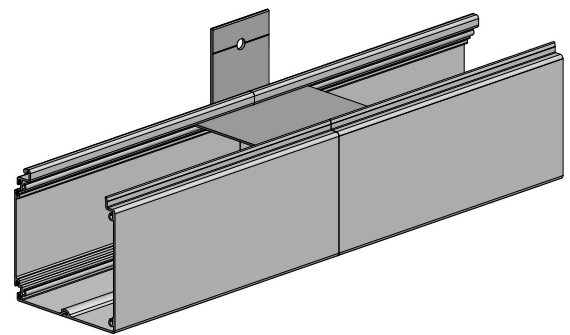
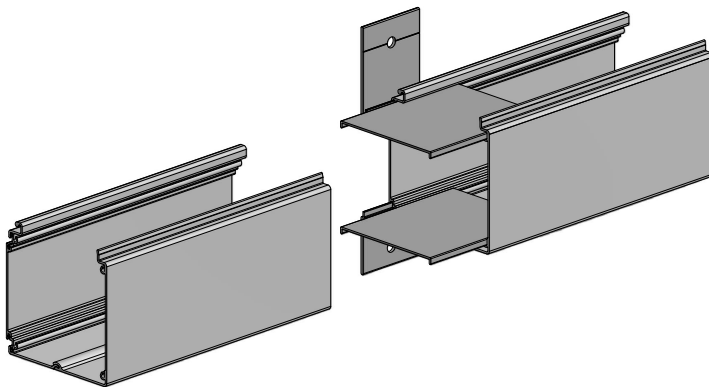

Channel Letter Raceway Bundles available in full lengths only.

EconoComp Kits

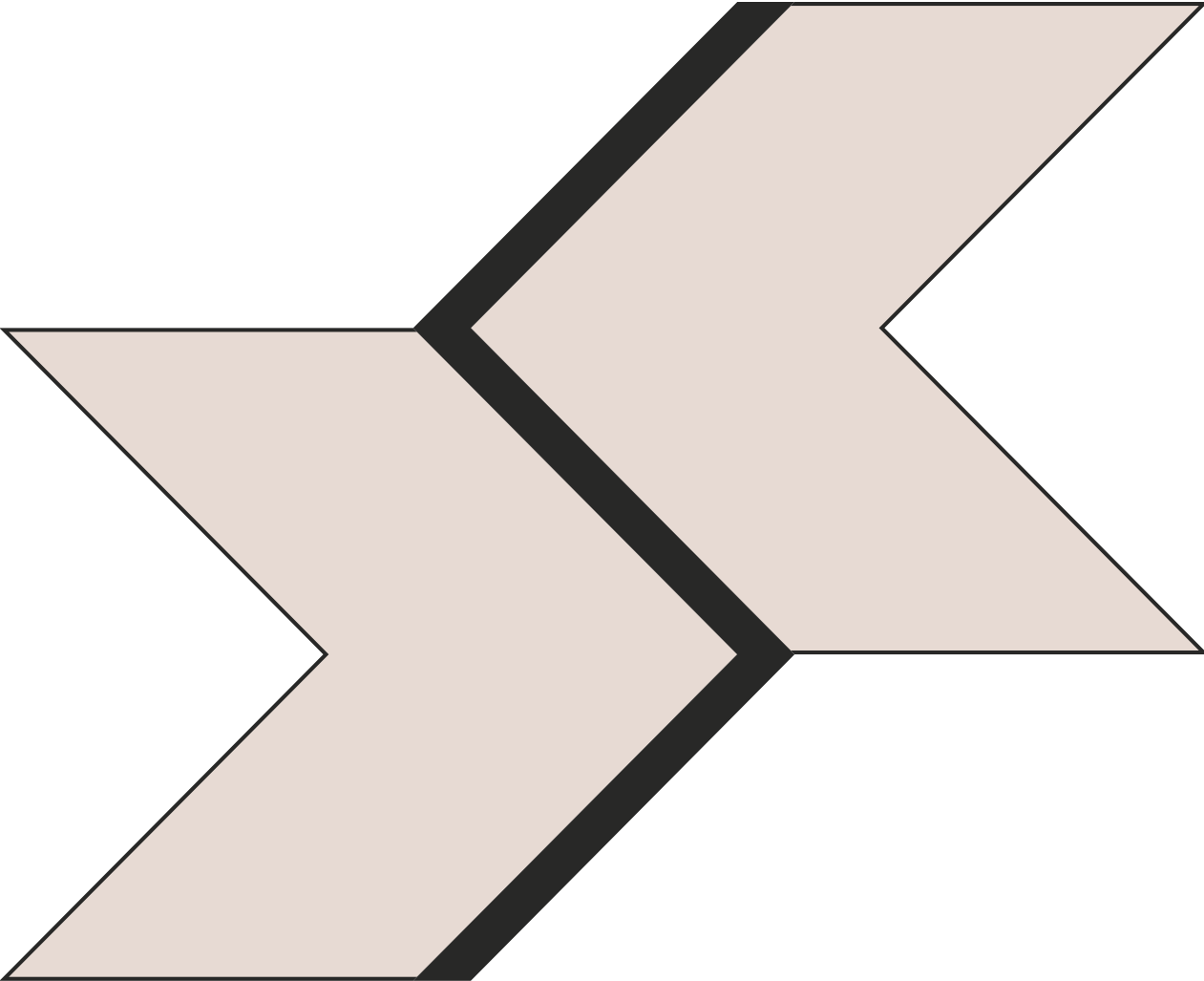

Unassembled Single Face Kits - For Rigid Faces

Single Face Filler w/ Econo Molding

Part #2034
K2034/56

Part #2056

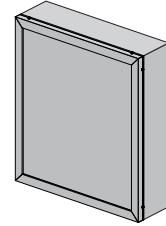
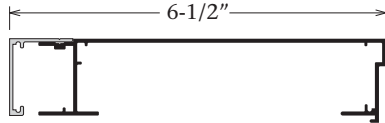

Size H'xW'	Mill Finish	Dk. Bronze	Size H'xW'	Mill Finish	Dk. Bronze	Size H'xW'	Mill Finish	Dk. Bronze	Size H'xW'	Mill Finish	Dk. Bronze
1 x 1	\$83	\$96	2 x 2	\$124	\$151	3 x 3	\$166	\$203	4 x 4	\$207	\$258
1 x 2	104	124	2 x 2.5	135	164	3 x 3.5	175	217	4 x 5	229	286
1 x 3	124	151	2 x 3	143	175	3 x 4	186	230	4 x 6	249	312
1 x 4	143	175	2 x 3.5	155	189	3 x 5	207	258	4 x 7	269	338
1 x 5	166	203	2 x 4	166	203	3 x 6	229	286	4 x 8	290	365
1 x 6	186	230	2 x 5	186	230	3 x 7	249	312	4 x 9	312	393
1 x 7	207	258	2 x 6	207	258	3 x 8	269	338	4 x 10	333	421
1 x 8	229	286	2 x 7	229	286	3 x 9	290	365	4 x 11	352	444
1 x 9	249	312	2 x 8	249	312	3 x 10	312	393	4 x 12	372	471
1 x 10	269	338	2 x 9	269	338	3 x 11	333	421	4 x 13	395	499
1 x 11	290	365	2 x 10	290	365	3 x 12	352	444	4 x 14	415	524
1 x 12	312	393	2 x 11	312	393	3 x 13	372	471	4 x 15	434	552
1 x 13	333	421	2 x 12	333	421	3 x 14	395	499			
1 x 14	352	444	2 x 13	352	444	3 x 15	415	524			
1 x 15	372	471	2 x 14	372	471						
			2 x 15	395	499						
1.5 x 1.5	104	124				3.5 x 3.5	186	230	5 x 5	249	312
1.5 x 2	114	136	2.5 x 2.5	143	175	3.5 x 4	197	242	5 x 6	269	338
1.5 x 2.5	124	151	2.5 x 3	155	189	3.5 x 5	218	269	5 x 7	290	365
1.5 x 3	135	164	2.5 x 3.5	166	203	3.5 x 6	238	296	5 x 8	312	393
1.5 x 3.5	143	175	2.5 x 4	175	217	3.5 x 7	259	324	5 x 9	333	421
1.5 x 4	155	189	2.5 x 5	197	242	3.5 x 8	281	352	5 x 10	352	444
1.5 x 5	175	217	2.5 x 6	218	269	3.5 x 9	302	378	5 x 11	372	471
1.5 x 6	197	242	2.5 x 7	239	297	3.5 x 10	321	404	5 x 12	395	499
1.5 x 7	217	270	2.5 x 8	259	325				6 x 6	290	365
1.5 x 8	238	296	2.5 x 9	280	353				6 x 7	312	393
1.5 x 9	259	324	2.5 x 10	299	380				6 x 8	333	421
1.5 x 10	281	352									

Kits Include:

- Mill finish or Dk. Bronze
- Cut to size and mitered fillers
- Cut to size and mitered moldings
- All screws required to assemble by mechanical fastening
- All Corner Keys required
- Packaging

Not Included in Kits:

- Face or Back
- Electrical Components
- Ballast Bracket(s)
- Back Braces and Gussets
- Raceway Covers and Cover Screws - See optional accessories
- Divider(s) - See optional accessories
- Mounting Provisions

Optional Accessories (pg 194):

- Raceway Covers and Cover Screws
- Divider(s)

Kit Specifications:

- It is recommended to order kits 1" over nominal T12 or T8 lamp size to utilize .040 flat Aluminum Raceway Covers
- Custom size kits may be cut to any dimension

Recommended Lamp Spacing:

- For illuminated backgrounds - 7" on center, using T12 or T8 lamps
- Always place lamps 3/4" from back of sign

Divider Kits Include:

- Cut to size dividers
- Divider Corner Angles
- All screws required to assemble by mechanical fastening
- 1-5/16" Econo Divider, Part #2140, Mill Finish \$5.15 and Dk. Bronze \$6.66 per/ft per/face

Additional Information (pgs 196-197)

Note: All dimensions are subject to the tolerance standards of the aluminum extrusion industry. Profile drawings are illustrative and rounded to the nearest 1/16".

CURRENT PRICE as of April 1, 2022



Unassembled Double Face Kits - For Rigid Faces

Medium Double Face Filler w/ Econo Molding

Part #2036
K2036/56

Part #2056

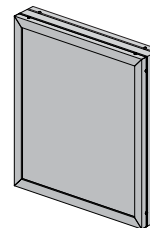
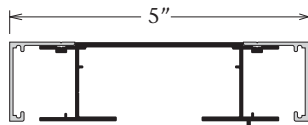

Size H'xW'	Mill Finish	Dk. Bronze	Size H'xW'	Mill Finish	Dk. Bronze	Size H'xW'	Mill Finish	Dk. Bronze	Size H'xW'	Mill Finish	Dk. Bronze
1 x 1	\$88	\$104	2 x 2	\$136	\$167	3 x 3	\$186	\$230	4 x 4	\$234	\$293
1 x 2	114	136	2 x 2.5	152	185	3 x 3.5	201	248	4 x 5	259	322
1 x 3	136	167	2 x 3	162	198	3 x 4	210	261	4 x 6	285	355
1 x 4	162	198	2 x 3.5	175	214	3 x 5	234	293	4 x 7	310	387
1 x 5	186	230	2 x 4	186	230	3 x 6	259	322	4 x 8	328	421
1 x 6	210	261	2 x 5	210	261	3 x 7	285	355	4 x 9	355	450
1 x 7	234	293	2 x 6	234	293	3 x 8	310	387	4 x 10	380	483
1 x 8	259	322	2 x 7	259	322	3 x 9	328	421	4 x 11	403	514
1 x 9	285	355	2 x 8	285	355	3 x 10	355	450	4 x 12	429	546
1 x 10	310	387	2 x 9	310	387	3 x 11	380	483	4 x 13	452	576
1 x 11	328	421	2 x 10	328	421	3 x 12	403	514	4 x 14	478	607
1 x 12	355	450	2 x 11	355	450	3 x 13	429	546	4 x 15	500	639
1 x 13	380	483	2 x 12	380	483	3 x 14	452	576			
1 x 14	403	514	2 x 13	403	514	3 x 15	478	607	5 x 5	285	355
1 x 15	429	546	2 x 14	429	546				5 x 6	310	387
			2 x 15	452	576	3.5 x 3.5	210	261	5 x 7	328	421
1.5 x 1.5	114	136				3.5 x 4	223	281	5 x 8	355	450
1.5 x 2	126	154	2.5 x 2.5	162	198	3.5 x 5	248	312	5 x 9	380	483
1.5 x 2.5	136	167	2.5 x 3	175	214	3.5 x 6	270	338	5 x 10	403	514
1.5 x 3	152	185	2.5 x 3.5	186	230	3.5 x 7	294	369	5 x 11	429	546
1.5 x 3.5	162	198	2.5 x 4	201	248	3.5 x 8	318	400	5 x 12	452	576
1.5 x 4	175	214	2.5 x 5	223	281	3.5 x 9	343	432			
1.5 x 5	201	248	2.5 x 6	248	312	3.5 x 10	368	464	6 x 6	328	421
1.5 x 6	223	281	2.5 x 7	271	341				6 x 7	355	450
1.5 x 7	246	310	2.5 x 8	293	369				6 x 8	380	483
1.5 x 8	270	338	2.5 x 9	320	401						
1.5 x 9	294	369	2.5 x 10	345	434						
1.5 x 10	318	400									

Kits Include:

- Mill finish or Dk. Bronze
- Cut to size and mitered fillers
- Cut to size and mitered moldings
- All screws required to assemble by mechanical fastening
- All Corner Keys required
- Packaging

Not Included in Kits:

- Faces
- Electrical Components
- Ballast Bracket(s)
- Internal Supports
- Raceway Covers and Cover Screws - See optional accessories
- Divider(s) - See optional accessories

Optional Accessories (pg 194):

- Raceway Covers and Cover Screws
- Divider(s)

Kit Specifications:

- Recommended for LED applications
- Custom size kits may be cut to any dimension

Divider Kits Include:

- Cut to size dividers
- Divider Corner Angles
- All screws required to assemble by mechanical fastening
- 1-5/16" Econo Divider, Part #2140, Mill Finish \$5.15 and Dk. Bronze \$6.66 per/ft per/face

Additional Information (pgs 196-197)

Unassembled Double Face Kits - For Rigid Faces

Large Double Face Filler w/ Econo Molding

Part #2032
K2032/56

Part #2056

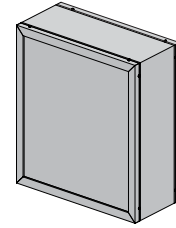
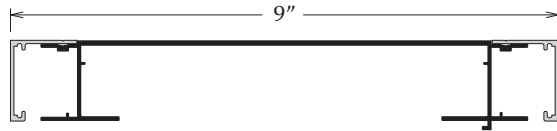

Size H'xW'	Mill Finish	Dk. Bronze	Size H'xW'	Mill Finish	Dk. Bronze	Size H'xW'	Mill Finish	Dk. Bronze	Size H'xW'	Mill Finish	Dk. Bronze
1 x 1	\$106	\$126	2 x 2	\$170	\$209	3 x 3	\$234	\$293	4 x 4	\$296	\$380
1 x 2	136	167	2 x 2.5	186	230	3 x 3.5	254	316	4 x 5	334	421
1 x 3	170	209	2 x 3	202	254	3 x 4	264	336	4 x 6	364	459
1 x 4	202	254	2 x 3.5	221	270	3 x 5	296	380	4 x 7	397	500
1 x 5	234	293	2 x 4	234	293	3 x 6	334	421	4 x 8	429	546
1 x 6	264	336	2 x 5	264	336	3 x 7	364	459	4 x 9	463	585
1 x 7	296	380	2 x 6	296	380	3 x 8	397	500	4 x 10	494	627
1 x 8	334	421	2 x 7	334	421	3 x 9	429	546	4 x 11	524	670
1 x 9	364	459	2 x 8	364	459	3 x 10	463	585	4 x 12	555	710
1 x 10	397	500	2 x 9	397	500	3 x 11	494	627	4 x 13	590	752
1 x 11	429	546	2 x 10	429	546	3 x 12	524	670	4 x 14	623	795
1 x 12	463	585	2 x 11	463	585	3 x 13	555	710	4 x 15	655	837
1 x 13	494	627	2 x 12	494	627	3 x 14	590	752			
1 x 14	524	670	2 x 13	524	670	3 x 15	623	795			
1 x 15	555	710	2 x 14	555	710						
			2 x 15	590	752						
1.5 x 1.5	136	167				3.5 x 3.5	264	336	5 x 5	364	459
1.5 x 2	155	189	2.5 x 2.5	202	254	3.5 x 4	285	355	5 x 6	397	500
1.5 x 2.5	170	209	2.5 x 3	221	270	3.5 x 5	316	397	5 x 7	429	546
1.5 x 3	186	230	2.5 x 3.5	234	293	3.5 x 6	348	441	5 x 8	463	585
1.5 x 3.5	202	254	2.5 x 4	254	316	3.5 x 7	381	483	5 x 9	494	627
1.5 x 4	221	270	2.5 x 5	285	355	3.5 x 8	413	523	5 x 10	524	670
1.5 x 5	254	316	2.5 x 6	316	397	3.5 x 9	445	566	5 x 11	555	710
1.5 x 6	285	355	2.5 x 7	348	440	3.5 x 10	478	607	5 x 12	590	752
1.5 x 7	317	399	2.5 x 8	380	483				6 x 6	429	546
1.5 x 8	348	441	2.5 x 9	412	523				6 x 7	463	585
1.5 x 9	381	483	2.5 x 10	444	564				6 x 8	494	627
1.5 x 10	413	523									

Kits Include:

- Mill finish or Dk. Bronze
- Cut to size and mitered fillers
- Cut to size and mitered moldings
- All screws required to assemble by mechanical fastening
- All Corner Keys required
- Packaging

Not Included in Kits:

- Faces
- Electrical Components
- Ballast Bracket(s)
- Internal Supports
- Raceway Covers and Cover Screws - See optional accessories
- Divider(s) - See optional accessories

Optional Accessories (pg 194):

- Raceway Covers and Cover Screws
- Divider(s)

Kit Specifications:

- It is recommended to order kits 1" over nominal T12 or T8 lamp size to utilize .040 flat Aluminum Raceway Covers
- Custom size kits may be cut to any dimension

Recommended Lamp Spacing:

- For illuminated backgrounds - 7" on center, using T12 or T8 lamps

Divider Kits Include:

- Cut to size dividers
- Divider Corner Angles
- All screws required to assemble by mechanical fastening
- 1-5/16" Econo Divider, Part #2140, Mill Finish \$5.15 and Dk. Bronze \$6.66 per/ft per/face

Additional Information (pgs 196-197)

Note: All dimensions are subject to the tolerance standards of the aluminum extrusion industry. Profile drawings are illustrative and rounded to the nearest 1/16".

CURRENT PRICE as of April 1, 2022



Unassembled Single Face Kits - For Rigid Faces

Single Face Filler w/ Extended Econo Molding

Part #2034
K2034/58

Part #2058

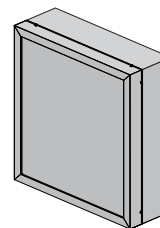
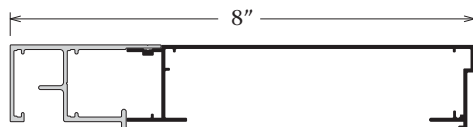

Size H'xW'	Mill Finish	Dk. Bronze	Size H'xW'	Mill Finish	Dk. Bronze	Size H'xW'	Mill Finish	Dk. Bronze	Size H'xW'	Mill Finish	Dk. Bronze
1 x 1	\$106	\$124	2 x 2	\$166	\$201	3 x 3	\$225	\$280	4 x 4	\$285	\$353
1 x 2	135	162	2 x 2.5	181	218	3 x 3.5	238	294	4 x 5	314	389
1 x 3	166	201	2 x 3	195	238	3 x 4	255	316	4 x 6	343	428
1 x 4	195	238	2 x 3.5	209	258	3 x 5	285	353	4 x 7	369	467
1 x 5	225	280	2 x 4	225	280	3 x 6	314	389	4 x 8	400	507
1 x 6	255	316	2 x 5	255	316	3 x 7	343	428	4 x 9	431	544
1 x 7	285	353	2 x 6	285	353	3 x 8	369	467	4 x 10	460	581
1 x 8	314	389	2 x 7	314	389	3 x 9	400	507	4 x 11	488	618
1 x 9	343	428	2 x 8	343	428	3 x 10	431	544	4 x 12	520	657
1 x 10	369	467	2 x 9	369	467	3 x 11	460	581	4 x 13	550	693
1 x 11	400	507	2 x 10	400	507	3 x 12	488	618	4 x 14	578	732
1 x 12	431	544	2 x 11	431	544	3 x 13	520	657	4 x 15	607	771
1 x 13	460	581	2 x 12	460	581	3 x 14	550	693			
1 x 14	488	618	2 x 13	488	618	3 x 15	578	732			
1 x 15	520	657	2 x 14	520	657						
			2 x 15	550	693						
1.5 x 1.5	135	162				3.5 x 3.5	255	316	5 x 5	343	428
1.5 x 2	152	182	2.5 x 2.5	195	238	3.5 x 4	269	336	5 x 6	369	467
1.5 x 2.5	166	201	2.5 x 3	209	258	3.5 x 5	296	371	5 x 7	400	507
1.5 x 3	181	218	2.5 x 3.5	225	280	3.5 x 6	327	409	5 x 8	431	544
1.5 x 3.5	195	238	2.5 x 4	238	294	3.5 x 7	357	447	5 x 9	460	581
1.5 x 4	209	258	2.5 x 5	269	336	3.5 x 8	387	485	5 x 10	488	618
1.5 x 5	238	294	2.5 x 6	296	371	3.5 x 9	416	524	5 x 11	520	657
1.5 x 6	269	336	2.5 x 7	327	411	3.5 x 10	445	563	5 x 12	550	693
1.5 x 7	297	372	2.5 x 8	357	448				6 x 6	400	507
1.5 x 8	327	409	2.5 x 9	387	487				6 x 7	431	544
1.5 x 9	357	447	2.5 x 10	416	523				6 x 8	460	581
1.5 x 10	387	485									

Kits Include:

- Mill finish or Dk. Bronze
- Cut to size and mitered fillers
- Cut to size and mitered moldings
- All screws required to assemble by mechanical fastening
- All Corner Keys required
- Packaging

Not Included in Kits:

- Face or Back
- Electrical Components
- Ballast Bracket(s)
- Back Braces and Gussets
- Raceway Covers and Cover Screws - See optional accessories
- Divider(s) - See optional accessories
- Mounting Provisions

Optional Accessories (pg 194):

- Raceway Covers and Cover Screws
- Divider(s) - (Extended Econo Molding is not engineered to directly integrate with the Econo Divider. Minimal additional assembly is required)

Kit Specifications:

- It is recommended to order kits 1" over nominal T12 or T8 lamp size to utilize .040 flat Aluminum Raceway Covers
- Custom size kits may be cut to any dimension

Recommended Lamp Spacing:

- For illuminated backgrounds - 10" on center, using T12 or T8 lamps
- Always place lamps 3/4" from back of sign

Divider Kits Include:

- Cut to size dividers
- Divider Corner Angles
- All screws required to assemble by mechanical fastening
- 1-5/16" Econo Divider, Part #2140, Mill Finish \$5.15 and Dk. Bronze \$6.66 per/ft per/face

Additional Information (pgs 196-197)

Unassembled Double Face Kits - For Rigid Faces

Medium Double Face Filler w/ Extended Econo Molding

Part #2036
K2036/58

Part #2058

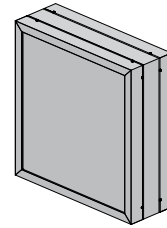
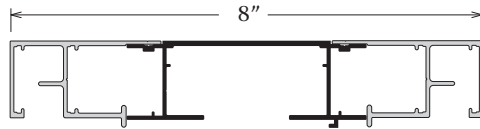

Size H'xW'	Mill Finish	Dk. Bronze	Size H'xW'	Mill Finish	Dk. Bronze	Size H'xW'	Mill Finish	Dk. Bronze	Size H'xW'	Mill Finish	Dk. Bronze
1 x 1	\$132	\$155	2 x 2	\$213	\$261	3 x 3	\$296	\$369	4 x 4	\$381	\$480
1 x 2	173	209	2 x 2.5	234	289	3 x 3.5	318	396	4 x 5	423	528
1 x 3	213	261	2 x 3	257	317	3 x 4	340	424	4 x 6	464	585
1 x 4	257	317	2 x 3.5	276	345	3 x 5	381	480	4 x 7	507	639
1 x 5	296	369	2 x 4	296	369	3 x 6	423	528	4 x 8	548	692
1 x 6	340	424	2 x 5	340	424	3 x 7	464	585	4 x 9	587	746
1 x 7	381	480	2 x 6	381	480	3 x 8	507	639	4 x 10	631	800
1 x 8	423	528	2 x 7	423	528	3 x 9	548	692	4 x 11	673	852
1 x 9	464	585	2 x 8	464	585	3 x 10	587	746	4 x 12	716	906
1 x 10	507	639	2 x 9	507	639	3 x 11	631	800	4 x 13	756	960
1 x 11	548	692	2 x 10	548	692	3 x 12	673	852	4 x 14	797	1011
1 x 12	587	746	2 x 11	587	746	3 x 13	716	906	4 x 15	840	1067
1 x 13	631	800	2 x 12	631	800	3 x 14	756	960			
1 x 14	673	852	2 x 13	673	852	3 x 15	797	1011	5 x 5	464	585
1 x 15	716	906	2 x 14	716	906				5 x 6	507	639
			2 x 15	756	960				5 x 7	548	692
1.5 x 1.5	173	209				3.5 x 3.5	340	424	5 x 8	587	746
1.5 x 2	192	236	2.5 x 2.5	257	317	3.5 x 4	362	452	5 x 9	631	800
1.5 x 2.5	213	261	2.5 x 3	276	345	3.5 x 5	400	500	5 x 10	673	852
1.5 x 3	234	289	2.5 x 3.5	296	369	3.5 x 6	444	555	5 x 11	716	906
1.5 x 3.5	257	317	2.5 x 4	318	396	3.5 x 7	485	610	5 x 12	756	960
1.5 x 4	276	345	2.5 x 5	362	452	3.5 x 8	524	664			
1.5 x 5	318	396	2.5 x 6	400	500	3.5 x 9	569	718	6 x 6	548	692
1.5 x 6	362	452	2.5 x 7	443	555	3.5 x 10	611	773	6 x 7	567	746
1.5 x 7	403	504	2.5 x 8	485	611				6 x 8	631	800
1.5 x 8	444	555	2.5 x 9	526	666						
1.5 x 9	485	610	2.5 x 10	567	720						
1.5 x 10	524	664									

Kits Include:

- Mill finish or Dk. Bronze
- Cut to size and mitered fillers
- Cut to size and mitered moldings
- All screws required to assemble by mechanical fastening
- All Corner Keys required
- Packaging

Not Included in Kits:

- Faces
- Electrical Components
- Ballast Bracket(s)
- Internal Supports
- Raceway Covers and Cover Screws - See optional accessories
- Divider(s) - See optional accessories

Optional Accessories (pg 194):

- Divider(s) - (Extended Econo Molding is not engineered to directly integrate with the Econo Divider. Minimal additional assembly is required)

Kit Specifications:

- Recommended for LED applications
- Custom size kits may be cut to any dimension

Divider Kits Include:

- Cut to size dividers
- Divider Corner Angles
- All screws required to assemble by mechanical fastening
- 1-5/16" Econo Divider, Part #2140, Mill Finish \$5.15 and Dk. Bronze \$6.66 per/ft per/face

Additional Information (pgs 196-197)

Note: All dimensions are subject to the tolerance standards of the aluminum extrusion industry. Profile drawings are illustrative and rounded to the nearest 1/16".

CURRENT PRICE as of April 1, 2022



Unassembled Double Face Kits - For Rigid Faces

Large Double Face Filler w/ Extended Econo Molding

Part #2032
K2032/58

Part #2058

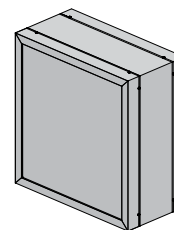
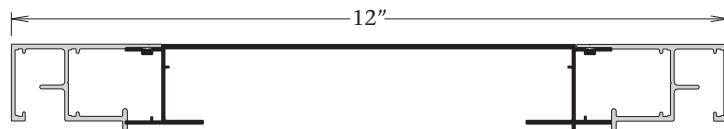

Size H'xW'	Mill Finish	Dk. Bronze	Size H'xW'	Mill Finish	Dk. Bronze	Size H'xW'	Mill Finish	Dk. Bronze	Size H'xW'	Mill Finish	Dk. Bronze
1 x 1	\$148	\$175	2 x 2	\$248	\$304	3 x 3	\$346	\$431	4 x 4	\$445	\$559
1 x 2	197	239	2 x 2.5	269	337	3 x 3.5	369	464	4 x 5	495	626
1 x 3	248	304	2 x 3	294	368	3 x 4	396	495	4 x 6	547	690
1 x 4	294	368	2 x 3.5	320	399	3 x 5	445	559	4 x 7	597	752
1 x 5	346	431	2 x 4	346	431	3 x 6	495	626	4 x 8	643	817
1 x 6	396	495	2 x 5	396	495	3 x 7	547	690	4 x 9	693	881
1 x 7	445	559	2 x 6	445	559	3 x 8	597	752	4 x 10	745	947
1 x 8	495	626	2 x 7	495	626	3 x 9	643	817	4 x 11	795	1010
1 x 9	547	690	2 x 8	547	690	3 x 10	693	881	4 x 12	844	1076
1 x 10	597	752	2 x 9	597	752	3 x 11	745	947	4 x 13	895	1137
1 x 11	643	817	2 x 10	643	817	3 x 12	795	1010	4 x 14	944	1205
1 x 12	693	881	2 x 11	693	881	3 x 13	844	1076	4 x 15	995	1267
1 x 13	745	947	2 x 12	745	947	3 x 14	895	1137			
1 x 14	795	1010	2 x 13	795	1010	3 x 15	944	1205	5 x 5	547	690
1 x 15	844	1076	2 x 14	844	1076				5 x 6	597	752
			2 x 15	895	1137	3.5 x 3.5	396	495	5 x 7	643	817
1.5 x 1.5	197	239				3.5 x 4	421	526	5 x 8	693	881
1.5 x 2	223	270	2.5 x 2.5	294	368	3.5 x 5	469	594	5 x 9	745	947
1.5 x 2.5	248	304	2.5 x 3	320	399	3.5 x 6	520	657	5 x 10	795	1010
1.5 x 3	269	337	2.5 x 3.5	346	431	3.5 x 7	570	721	5 x 11	844	1076
1.5 x 3.5	294	368	2.5 x 4	369	464	3.5 x 8	618	784	5 x 12	895	1137
1.5 x 4	320	399	2.5 x 5	421	526	3.5 x 9	670	849			
1.5 x 5	369	464	2.5 x 6	469	594	3.5 x 10	720	914	6 x 6	643	817
1.5 x 6	421	526	2.5 x 7	520	658				6 x 7	693	881
1.5 x 7	471	592	2.5 x 8	571	721				6 x 8	745	947
1.5 x 8	520	657	2.5 x 9	622	785						
1.5 x 9	570	729	2.5 x 10	670	849						
1.5 x 10	618	784									

Kits Include:

- Mill finish or Dk. Bronze
- Cut to size and mitered fillers
- Cut to size and mitered moldings
- All screws required to assemble by mechanical fastening
- All Corner Keys required
- Packaging

Not Included in Kits:

- Faces
- Electrical Components
- Ballast Bracket(s)
- Internal Supports
- Raceway Covers and Cover Screws - See optional accessories
- Divider(s) - See optional accessories

Optional Accessories (pg 194):

- Raceway Covers and Cover Screws
- Divider(s) - (Extended Econo Molding is not engineered to directly integrate with the Econo Divider. Minimal additional assembly is required)

Kit Specifications:

- It is recommended to order kits 1" over nominal T12 or T8 lamp size to utilize .040 flat Aluminum Raceway Covers
- Custom size kits may be cut to any dimension

Recommended Lamp Spacing:

- For illuminated backgrounds - 10" on center, using T12 or T8 lamps

Divider Kits Include:

- Cut to size dividers
- Divider Corner Angles
- All screws required to assemble by mechanical fastening
- 1-5/16" Econo Divider, Part #2140, Mill Finish \$5.15 and Dk. Bronze \$6.66 per/ft per/face

Additional Information (pgs 196-197)

EconoComp System Optional Accessories

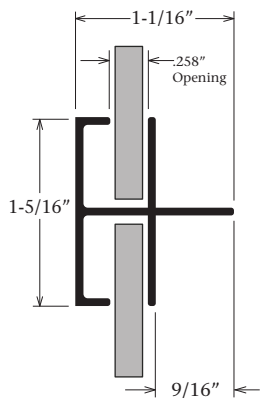
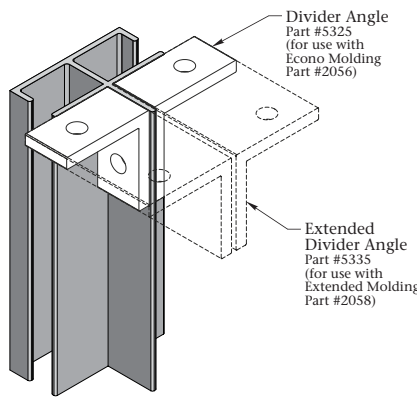
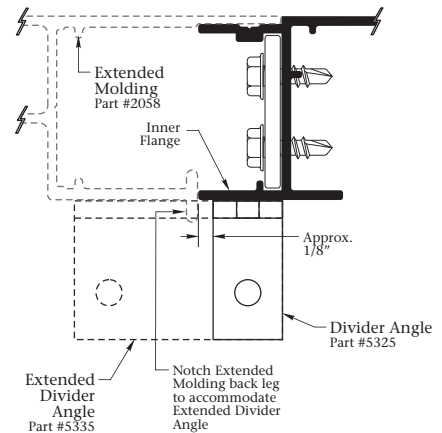
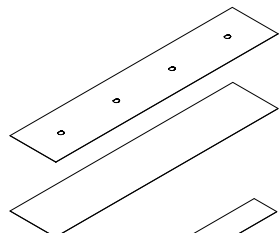
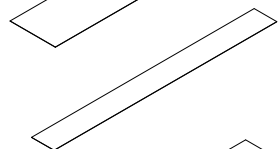
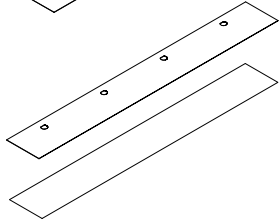
Dividers	Part	Part Number	Cost/Ft Mill Finish	Cost/Ft Dk. Bronze
Cut To Size Divider				
	1-5/16" Econo Divider Included: <ul style="list-style-type: none"> • Screws for mechanical fastening • Divider Corner Angles (For Econo Molding) • Extended Corner Angles (For Extended Econo Molding) 	K2140	\$5.15	\$6.66
Cut To Size Divider Specifications				
				
<p>Note: 1-5/16" Econo Divider is engineered for use with the Econo Molding. For use with the Extended Econo Molding, attach the Econo Divider to the Inner Flange using the Extended Divider Angle, part #5335 as noted and shown above.</p>				
Components	Part	Part Number	Price Each	
Raceway Covers				
	Large Double Filler Raceway Cover 6-1/2" x 48" x .040" (white)			
	Pre-Punched 7" centers	5086	\$25.23	
	Pre-Punched 10" centers	5087	25.23	
	Blank	5088	14.57	
	Medium Double Filler Raceway Cover 3" x 48" x .040" (white)			
	Blank	5085	7.30	
	Single Face Filler Raceway Cover 5-1/8" x 48" x .040" (white)			
	Pre-Punched 7" centers	5082	19.61	
	Pre-Punched 10" centers	5083	19.61	
	Blank	5084	11.21	

Cutting Services

Commercial - Architectural - Standard - EconoComp

Kerf-cuts

Note: This cutting process is best suited for retro frames, however it can also work well with retainers, bodies and more.

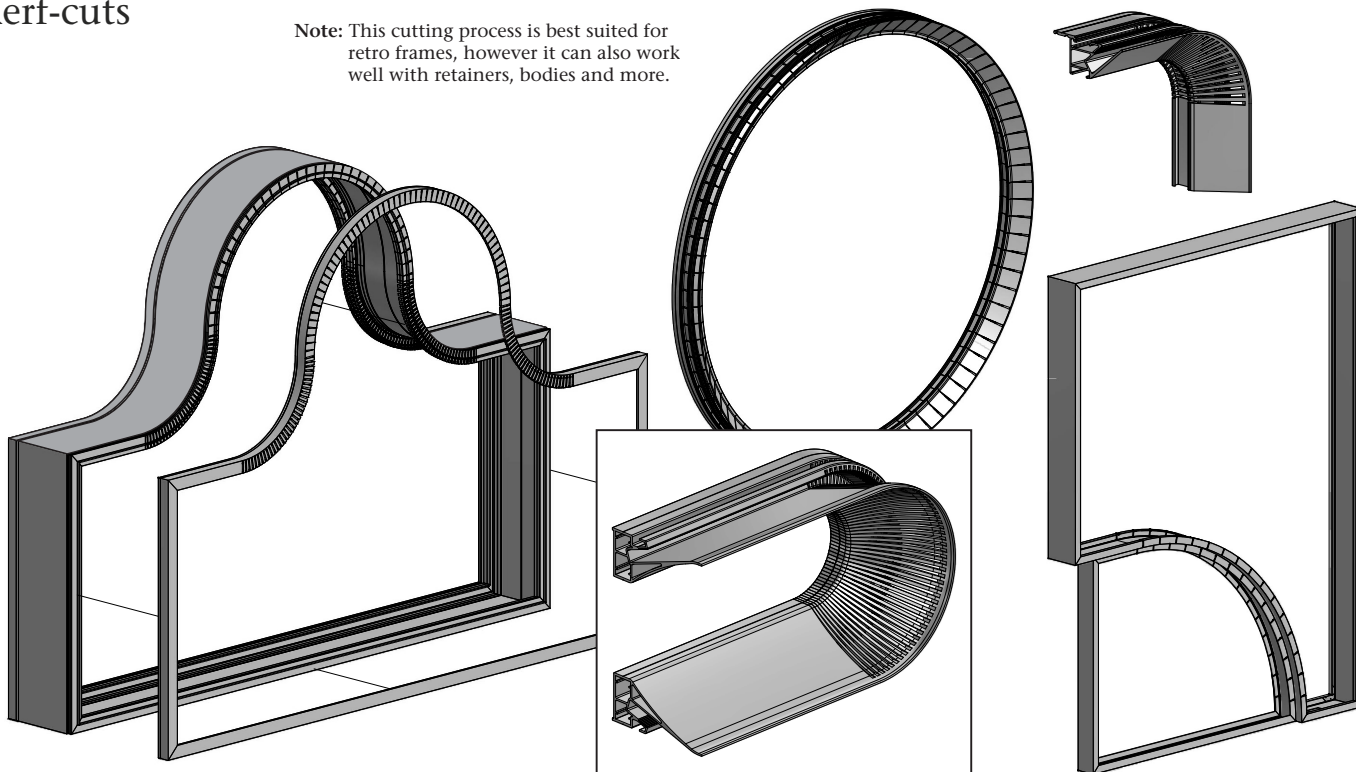

A series of relief cuts are placed in the extrusion to form a custom shape. Add straps or weld to create and maintain the shape (not provided by SignComp). Offered in pre-cut lengths or pre-cut kits.

Special Miters

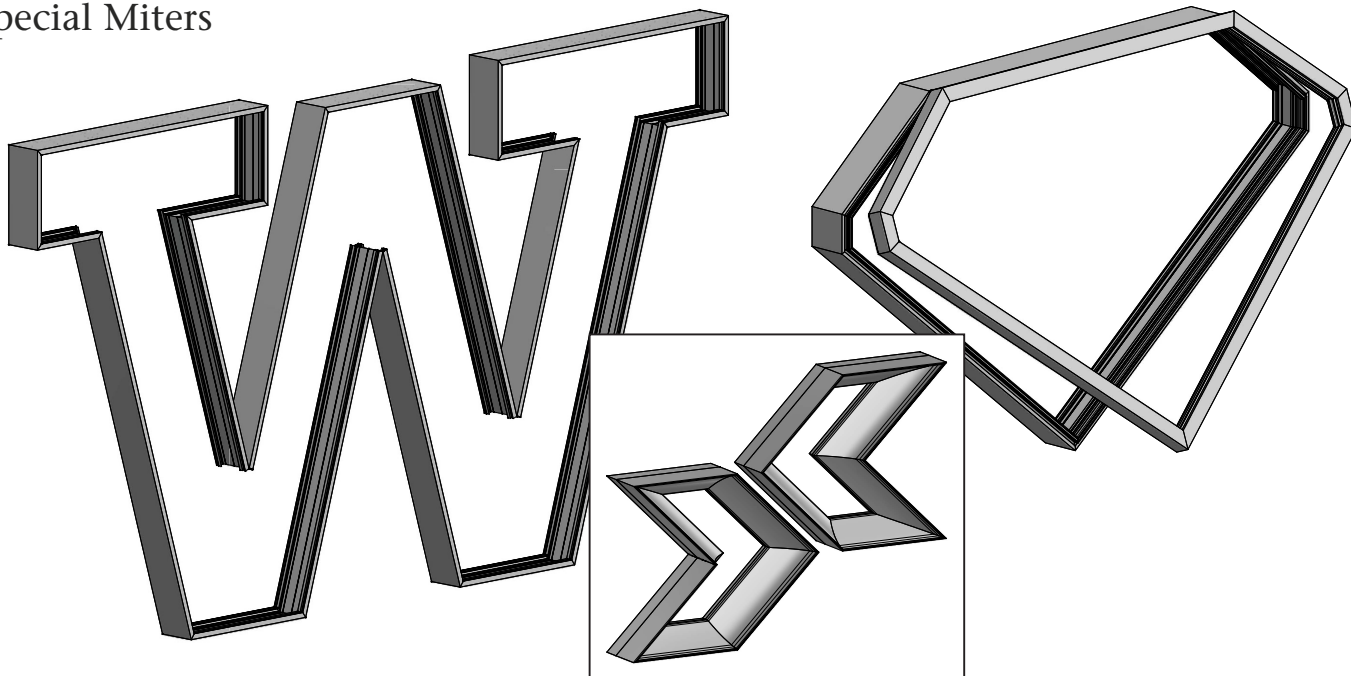

Pre-cut kits are available for custom angles. Custom angle hardware is not available.



Note: All dimensions are subject to the tolerance standards of the aluminum extrusion industry. Profile drawings are illustrative and rounded to the nearest 1/16".

Additional Information

Extrusion Guidelines

Commercial

Size of Sign	Single Face Body Typically limited by the comfort factor for hinging the faces open for service Medium Body Typically limited to approximately 64 square feet Wide Body Typically limited by the comfort factor for hinging the faces open for service 1-1/2" Retainer Typically limited to 32 square feet 1-1/2" Retainer II Typically limited to 60 square feet Fascia Frames Typically limited to 6' in height - unlimited length
Steel Support	Medium Body Up to a 3" steel support Wide Body Up to a 6" steel support Flat 2 Piece Double Face Body Up to a 12" steel support Flat 2 Piece Double Face Medium Body Up to a 8" steel support Flat Double Face Body Up to a 6" steel support Flat Double Face Medium Body Up to a 2" steel support

Architectural

Size of Sign	Series 7 & 12 Hinge Bodies Typically limited by the comfort factor for hinging the faces open for service Slide Retainer Typically limited to 60 square feet - Contact SignComp Engineering for larger applications
Steel Support	Series 7 Post & Panel Bodies Up to a 4" steel support Series 7 Hinge Body Up to a 2-1/2" steel support Series 12 Hinge Body Up to a 6" steel support

Standard

Size of Sign	1Part 2Part Bodies w/ Retainer Systems Typically limited to 72 square feet (can be larger with the proper use of internal support(s) and sufficient hanging bars)
Steel Support	1Part / 2Part 6" Double Face Body Up to a 2" steel support 1Part / 2Part 9" Double Face Body Up to a 3" steel support 1Part / 2Part 12" Double Face Body Up to a 6" steel support

EconoComp

Size of Sign	Fillers w/ Molding Systems Typically limited to 48 square feet - Contact SignComp Engineering for larger applications
Steel Support	Medium Double Face Filler Up to a 1" steel support Large Double Face Filler Up to a 4" steel support

Round, square or rectangular supports may be used. Do not exceed recommended max sizes.

Note: SignComp extrusions are engineered and designed to allow for a wide latitude of designs and applications. The fabrication techniques and material selection are at the sole discretion of the individual fabricator.

Additional Information

- Kits**
- **Most profiles are available in cut to size kits**
 - **Commercial** bodies and retainers should be cut 1" longer than the nominal T12 or T8 lamp size for horizontal or vertical lamping
 - **Standard** bodies and retainers should be cut 1-3/4" longer than the nominal T12 or T8 lamp size for horizontal or vertical lamping (The 6" D/F bodies and retainers should be cut 1" longer than the nominal T12 or T8 lamp size for horizontal or vertical lamping)
 - **EconoComp** fillers and moldings should be cut 1" longer than the normal T12 or T8 lamp size for horizontal or vertical lamping
 - General guidelines for lamp spacing: Double the distance between the front of the lamp and the back of the plastic face for your center to center lamp measurement. Maximum center to center is 12"
 - Extrusion bodies, retainers, frames and covers are engineered for mechanical fastening, bonding with adhesive, or welded assembly
 - It is recommended to use safety chains and prop-bars on all hingeable faces
 - Assembly instructions available

- Included in Kits**
- Mill Finish, Dk. Bronze or Clear Anodized
 - Cut to size and mitered bodies
 - Cut to size and mitered retainers, frames and covers
 - All Body Corner Angles and/or Corner Keys as required
 - Packaging

- Included in Vandal System:**
- Cut to size and mitered Inner Frame(s)
 - Cut to size and mitered Outer Frame(s)
 - Cut to size Hinge
 - Locks

- Not Included in Kits**
- Faces or Backs
 - Electrical components
 - Structural supports, Frame Support Tube, back braces, gussets and mounting provisions
 - Attachment of Hinge
 - Drilling of holes for locks and attachment of locks

- Mill Finish Dk. Bronze**
- No prior surface preparation. Surface scratches, die lines and imperfections present. **Not ready for paint**
 - Exposed aluminum surfaces are coated with Quaker Dark Bronze primer/topcoat
 - Limited additional colors are available, minimum order will apply

- Clear Anodized**
- SignComp anodizes a mill finish product, therefore mill finish characteristics will be an integral part of the anodized product
 - Die lines and imperfections may be seen but not felt on the finished product

- Pricing**
- All prices are effective as of February 1, 2022. Due to fluctuation in the raw aluminum market, prices are subject to change without notice
 - Packaging is included in list prices
 - For full length extrusion and hardware pricing see Product Guide

General Information

Freight Policy

- Freight shall be prepaid, F.O.B. SignComp in Grand Rapids, Michigan for single orders of extrusion and/or accessories whereby the invoiced amount is \$7,500.00 or more to any single destination within the continental United States or Canada
- Freight shall be collect, F.O.B. SignComp in Grand Rapids, Michigan for all orders other than as stated in this freight policy
- All freight claims for freight collect shipments are the sole responsibility of the buyer
- SignComp will assist with freight claims. Bill of lading must be signed for as damaged
- Any requests for expedited freight services shall be the sole expense of the buyer

Minimum Order

- Any single full length extrusion profile and/or prepackaged accessories
- Any single kit

Standard Lead Times

- Full length extrusion and accessory orders ship within two (2) - three (3) days upon receipt and acceptance of purchase order
- Cut to size kits and cut extrusion orders ship within three (3) - four (4) days upon receipt and acceptance of purchase order
- All orders will receive an approximate ship date upon receipt and acceptance of purchase order and confirmation
- For custom kits and large quantities call Customer Service for lead times

Return Policy

- Returns of SignComp products will not be accepted without prior authorization and written RMA number from SignComp
- Materials may not be returned for any reason other than defective product or incorrect fulfillment of order
- All goods to be returned must be acknowledged in writing within the 60 day grace period from the date of the shipment. Any claims after this period will be considered invalid
- All returned goods **must be in new and saleable condition** for full credit to be issued

Additional Product Service Offerings

- Custom extrusions
- Mill Run extrusion orders
- Kerf Cutting

Exclusive Warranty and Remedies

- In effect as of January 1, 2008
- This is the exclusive warranty policy of SignComp, LLC, Grand Rapids, Michigan 49544 (the "Company") with respect to any and all of its products

Exclusive Warranty

- The Company warrants you as the original purchaser that the Company's products will be free from defects in materials and workmanship, under normal conditions, upon shipment of said products from the Company, for 30 days
- This exclusive warranty does not apply to damage caused by improper handling, therefore the company shall have no liability or responsibility for any damage whatsoever caused by handling
- The Company hereby disclaims any and all other warranties, including, without limitation, implied warranties of merchantability and fitness for a particular purpose. The only warranty with respect to the Company's products is described in this exclusive warranty. No oral or written representations shall extend the Company's exclusive warranty beyond that description herein.

Warranty Procedures

- The purchaser must notify the Company of any warranty claim prior to initiating any remedy upon the defective product. Upon receipt of such notice, the Company will direct that an authorized representative inspect the product and, if necessary, correct the defect in accordance with this exclusive warranty. The Company shall have the exclusive right to determine whether or not a defect is covered by this exclusive warranty.

Remedies

- Provided that the warranty procedures are followed, the Company will repair and/or replace the defective SignComp product(s) during the applicable warranty period without charge for parts or labor
- Repair and/or replacement of defective SignComp products is your exclusive remedy under the Company's exclusive warranty
- The Company shall not be liable for any incidental or consequential damages if the Company's product is defective or does not conform to this exclusive warranty. In any event the maximum amount for which the Company shall be liable to the purchaser shall be the original purchase price of the defective SignComp product(s).
- Any claim for breach of this exclusive warranty shall be brought, if at all, no later than 30 days from the Company's breach

Address for Notification

- Notice of a product defect covered by this exclusive warranty can be made in writing or by telephone. The Company's address and telephone numbers are:

SignComp, LLC
 3032 Walker Ridge Dr. NW
 Grand Rapids, MI. 49544
 Attention: Customer Service
 Phone: (616) 784-0405
 Toll Free: (877) 784-0405
 Fax: (616) 784-0411
 E-mail: signcomp@signcomp.com

Environmentally Friendly



Products Processes Facility



3032 Walker Ridge Dr. NW
Grand Rapids, MI 49544
U.S.A.
toll free: (877) 784-0405 (US and Canada)
local: (616) 784-0405
fax: (616) 784-0411
email: signcomp@signcomp.com

www.signcomp.com
© SignComp LLC April 2022