

Features & Benefits

The Standard Product Line is engineered for fast, easy assembly. Each kit includes body angles that allow for bonding, welding or mechanical fastening. The body is extruded with large inner body flanges to provide for the attachment of internal structure and simple attachment of raceway covers. Hanging bar tabs are designed into the retainer and frames to hang the faces from, giving the face a flat appearance and assisting in the prevention of the face blowing out. Keyed alike locks and the piano hinge are included. It is available in Mill Finish and Dark Bronze.

Answers to FAQ's

- The frames accept up to 1/4" thick face material
- Inner face trim size - Deduct 3/8" from the overall height and width
- Outer face trim size - Deduct 2-3/16" from the overall height and width
- Header face trim size - Deduct 3/8" from the overall cabinet height and width
- Reader visible opening - Deduct 4" from the cabinet height and width
- Header visible opening - Deduct 3-1/4" from the cabinet height and width
- Add 1-3/4" in the direction of the lamp to allow for Standard T12 bulbs to fit
- Recommended lamp spacing is 7" on center
- Not designed to be used with SignComp's gas supports

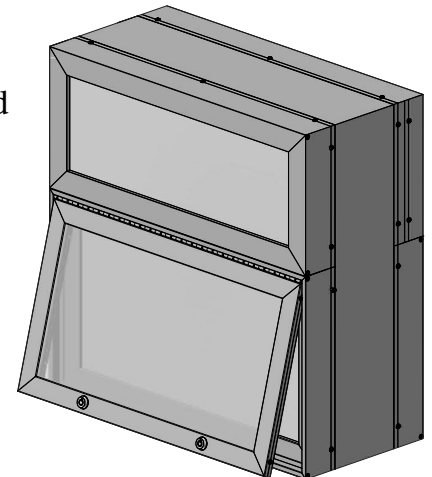

Optional Items

- Raceway Cover
- Socket Raceway