

Available with or without posts

Features & Benefits

The Series 2 Bleed Body gives the post and panel a frameless appearance. The body can integrate with any of the 12 post options below. This is available in Mill Finish.

Answers to FAQ's

- Recommended panel thickness .100.
- Face material trim size - Deduct 1/4" from the height and width.

Optional Item

- Face material. (Available in Mill Finish only.)

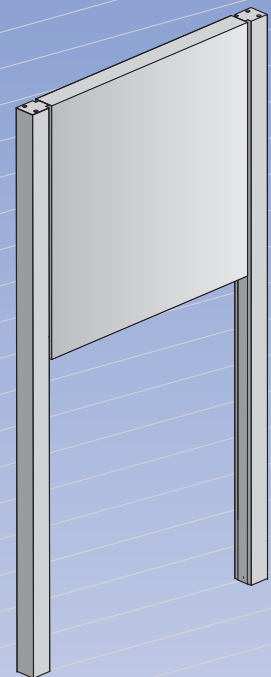

12 Post Options

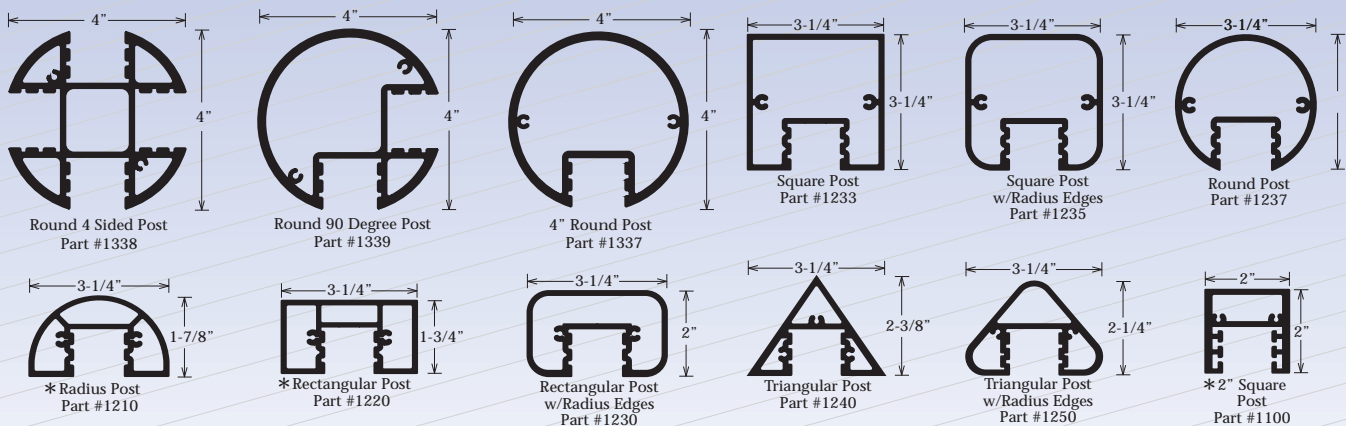

*Post options available in a Bronze Finish