

Available with
or without posts

Features & Benefits

The Series 3 Slide Body gives the post and panel a framed appearance. The top and bottom body sections are pre-drilled and countersunk to allow for the panels to be changed easily. The body can integrate with any of the 12 post options below. This is available in Mill Finish or Dark Bronze.

Answers to FAQ's

- Recommended panel thickness .100.
- Face material trim size - Deduct 3/8" from the height and width.

Optional Item

- Face material. (Available in Mill Finish only.)

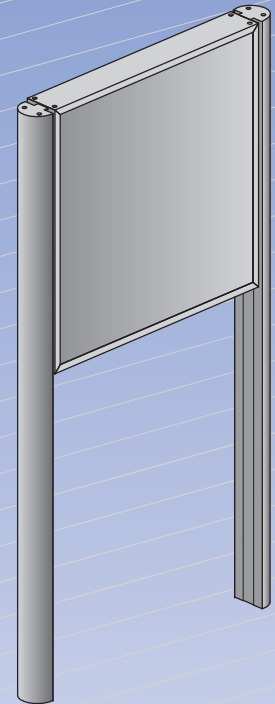

12 Post Options

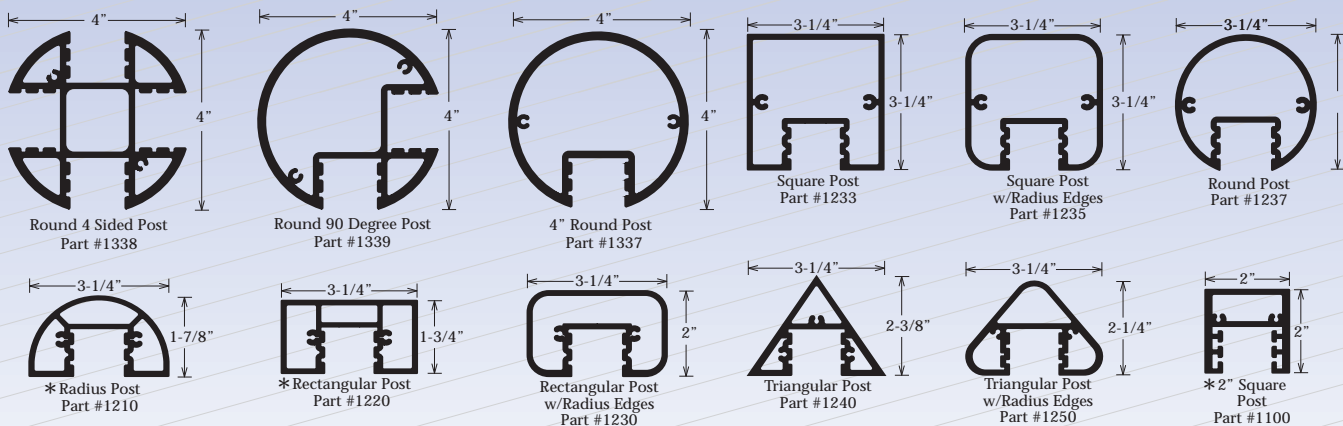

*Post options available in a Bronze Finish