

Features & Benefits

The Series 2/3 - 1/8" Panel Adaptor offers an affordable interchangeable solution for post and panel applications. The Adaptors attach to the vertical sides of the panel, the panel and Adaptors then slide into the post. The Adaptor can be used with any rigid PVC sheet stock, hardwood core, corrugated plastic core, or solid core laminate sheet stock. The Adaptor can integrate with any of the 12 post options below. This is available in a Mill or Dark Bronze Finish.

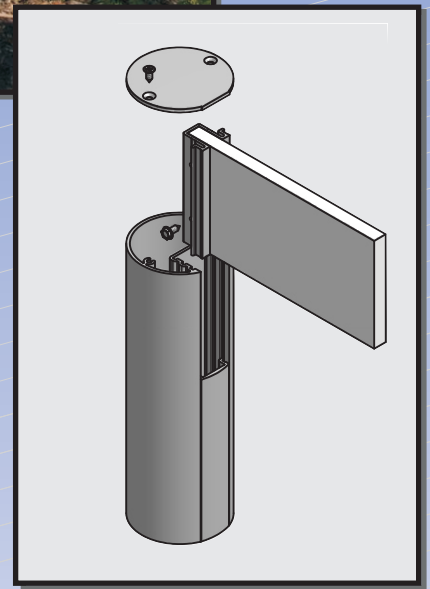

Answers to FAQ's

- Designed for 1/8" thick faces.
- Panel trim is not available.

12 Post Options

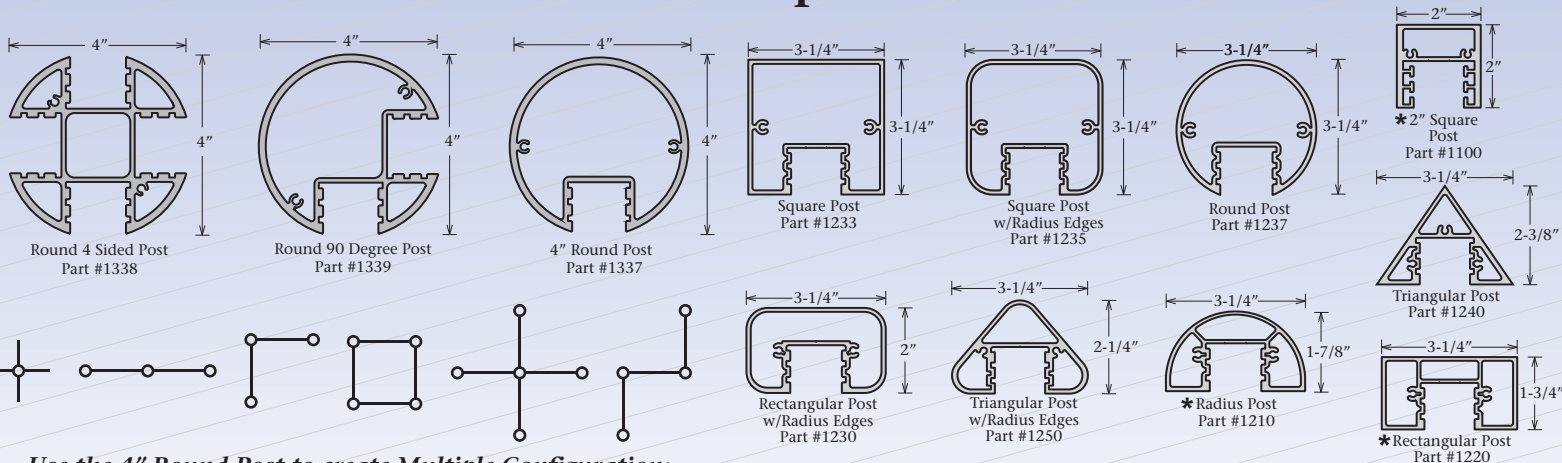

Use the 4" Round Post to create Multiple Configuration:

*Post options available in a Bronze Finish