

SERIES 3 POST & PANEL:
 SERIES 3 - 3/4" TRIANGULAR POST
 PART #1240
 SERIES 2-3 REVEAL
 PART #1200
 SERIES 3 - 3/4" SLIDE BODY
 PART #1260

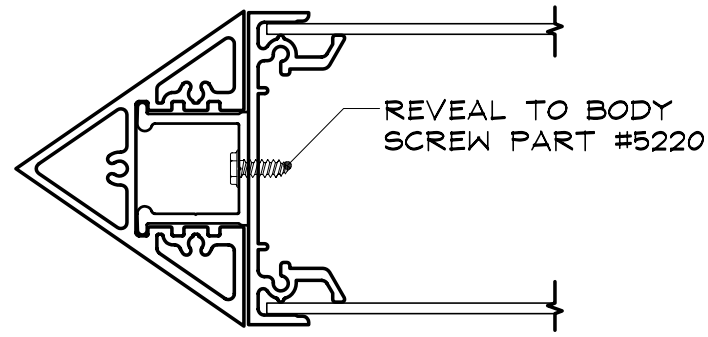

0" REVEAL POSITION

SCALE : 1/2" = 1"

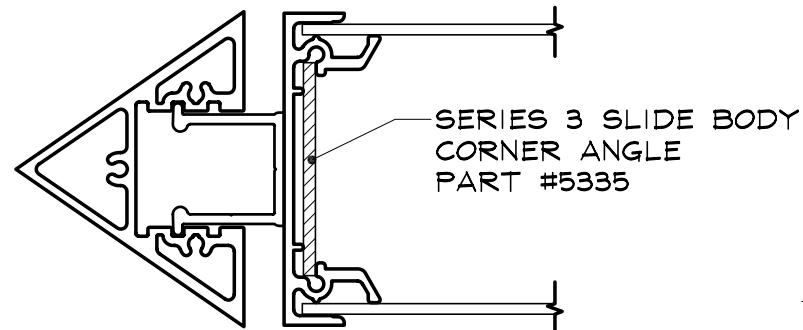

3/8" REVEAL POSITION

SCALE : 1/2" = 1"

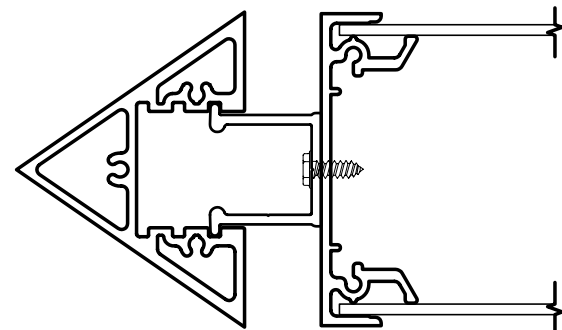

3/4" REVEAL POSITION

SCALE : 1/2" = 1"

FINISH GRADE
OR
TOP OF FOOTING

INSERT FILLER
INTO POST TACK
WELD IT UP TIGHT UP
AGAINST SIGN BOTTOM
LEAVING 6" OF FILLER
BELOW GRADE.

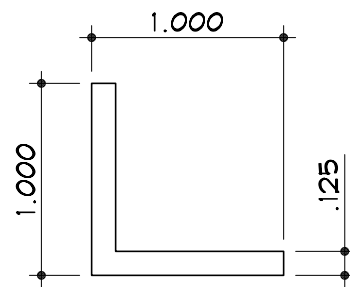
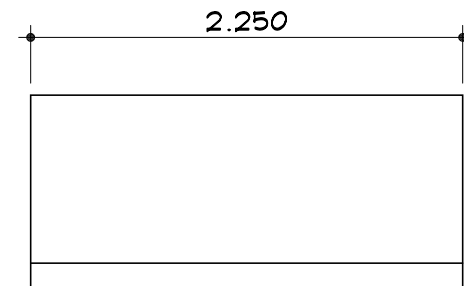

CORNER ANGLE PART #5335

SCALE : 1" = 1"

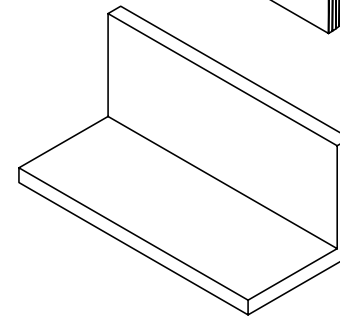
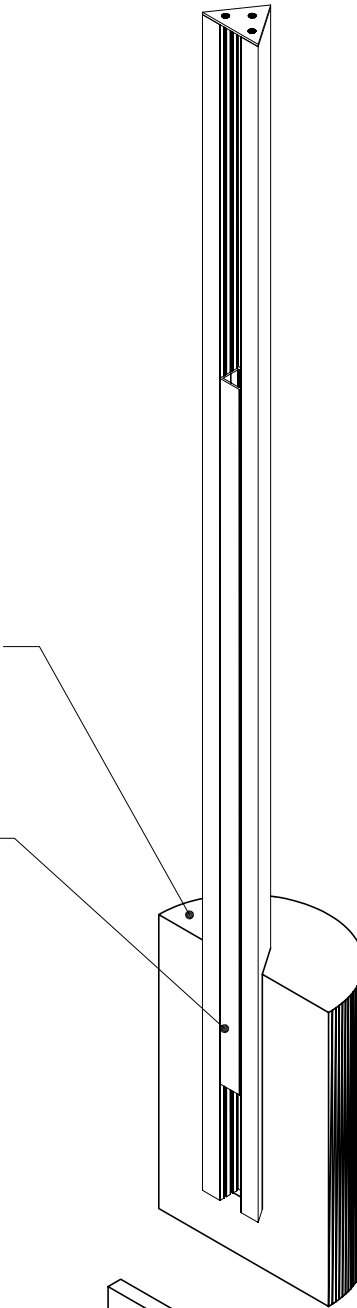

INSTALL REVEAL PIECE
1/8" BELOW TOP OF SIGN
TO ALLOW POST CAP
TO ALIGN FLUSH WITH
TOP OF SIGN.

SER 3 - 1240-1

