

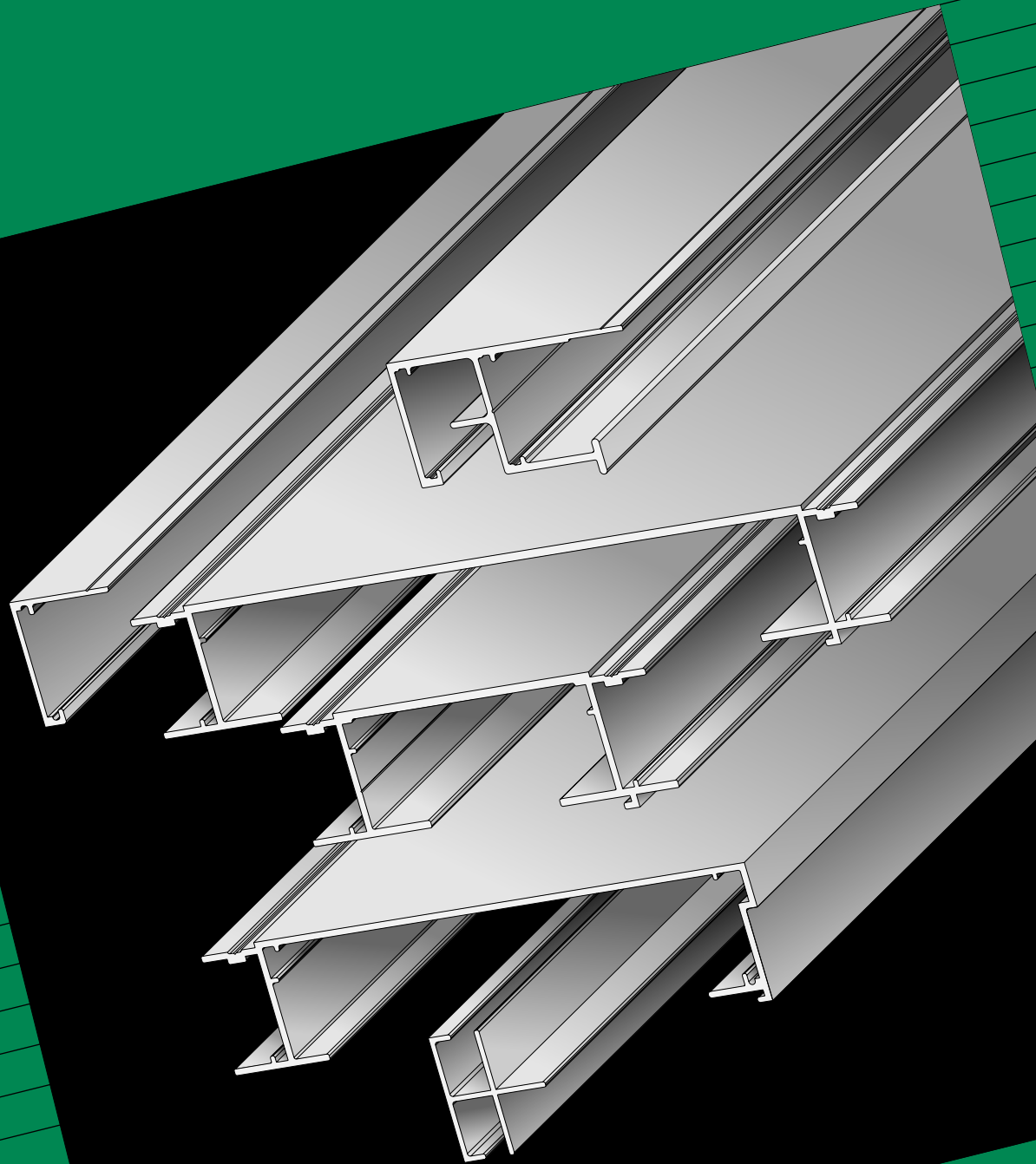

EconoComp™
Product









Sign Cabinet Kits



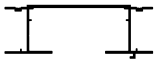
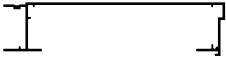

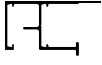

<h3>General Information</h3>	<ul style="list-style-type: none"> □ The filler and molding shall be cut 1" longer than the nominal T-12 lamp size for horizontal or vertical lamping. □ General guideline for T-12 lamp spacing: Double the distance between the front of the lamp and the back of the plastic face for your center to center lamp measurement. Maximum center to center is typically 12". □ Extrusion fillers and moldings are engineered for mechanical fastening assembly. □ Extended Econo Molding, part #2058, is not engineered to directly integrate with the Econo Divider, Part #2140. Minimal additional assembly is required using the Extended Divider Angle, part #5335. See page 11 □ Additional information. See below 																						
<h3>Included in Kit Pricing</h3>	<ul style="list-style-type: none"> □ Mill finish or Pre-painted. □ Cut to size and mitered filler extrusion. □ Cut to size and mitered molding extrusion. □ All screws required to assemble by mechanical fastening. □ Corner Keys required. □ Packaging. 																						
<h3>Not Included in Kit Pricing</h3>	<ul style="list-style-type: none"> □ Face and Back. □ Raceway Covers. □ Raceway Cover Screws. □ Ballast Brackets. □ Corner Angles - Not required for assembly. □ Electrical Components. □ Structural Supports. 																						
<h3>Mill Finish</h3>	<ul style="list-style-type: none"> □ No prior surface preparation. Surface scratches, die lines and imperfections present. □ Not ready for paint. 																						
<h3>Pre-Painted</h3>	<ul style="list-style-type: none"> □ Exposed aluminum surfaces are coated with Quaker Dark Bronze primer/topcoat. □ Limited additional colors are available, minimum order will apply. 																						
<h3>Pricing</h3>	<ul style="list-style-type: none"> □ All prices are effective as of March 1, 2015. Due to fluctuation in the raw aluminum market, prices are subject to change without notice. □ Packaging is included in listed prices. □ Freight. See freight policy page 11 																						
<h3>Raceway Covers</h3>	<table border="0"> <tr> <td data-bbox="373 1291 495 1459"> </td> <td data-bbox="503 1323 820 1438"> <p>Single Face Raceway Cover 5-1/8" x 48" x .040" (white) Pre-Punched 7" on Center Pre-Punched 10" on Center Blank</p> <table border="0"> <tr> <td>Part Number</td> <td>Part</td> <td>Price Each</td> </tr> <tr> <td>5082</td> <td>5082</td> <td>\$12.60</td> </tr> <tr> <td>5083</td> <td>5083</td> <td>\$12.60</td> </tr> <tr> <td>5084</td> <td>5084</td> <td>\$7.20</td> </tr> </table> </td> <td data-bbox="909 1291 1031 1459"> </td> <td data-bbox="1039 1281 1502 1470"> <table border="0"> <tr> <td>Medium Double Face Raceway Cover 3" x 48" x .040" (white) Blank</td> <td>Part Number 5085</td> <td>Price Each \$4.69</td> </tr> <tr> <td>Large Double Face Raceway Cover 6-1/2" x 48" x .040" (white) Pre-Punched 7" on Center Pre-Punched 10" on Center Blank</td> <td>5086 5087 5088</td> <td>\$16.20 \$16.20 \$9.36</td> </tr> </table> </td> </tr> </table>		<p>Single Face Raceway Cover 5-1/8" x 48" x .040" (white) Pre-Punched 7" on Center Pre-Punched 10" on Center Blank</p> <table border="0"> <tr> <td>Part Number</td> <td>Part</td> <td>Price Each</td> </tr> <tr> <td>5082</td> <td>5082</td> <td>\$12.60</td> </tr> <tr> <td>5083</td> <td>5083</td> <td>\$12.60</td> </tr> <tr> <td>5084</td> <td>5084</td> <td>\$7.20</td> </tr> </table>	Part Number	Part	Price Each	5082	5082	\$12.60	5083	5083	\$12.60	5084	5084	\$7.20		<table border="0"> <tr> <td>Medium Double Face Raceway Cover 3" x 48" x .040" (white) Blank</td> <td>Part Number 5085</td> <td>Price Each \$4.69</td> </tr> <tr> <td>Large Double Face Raceway Cover 6-1/2" x 48" x .040" (white) Pre-Punched 7" on Center Pre-Punched 10" on Center Blank</td> <td>5086 5087 5088</td> <td>\$16.20 \$16.20 \$9.36</td> </tr> </table>	Medium Double Face Raceway Cover 3" x 48" x .040" (white) Blank	Part Number 5085	Price Each \$4.69	Large Double Face Raceway Cover 6-1/2" x 48" x .040" (white) Pre-Punched 7" on Center Pre-Punched 10" on Center Blank	5086 5087 5088	\$16.20 \$16.20 \$9.36
	<p>Single Face Raceway Cover 5-1/8" x 48" x .040" (white) Pre-Punched 7" on Center Pre-Punched 10" on Center Blank</p> <table border="0"> <tr> <td>Part Number</td> <td>Part</td> <td>Price Each</td> </tr> <tr> <td>5082</td> <td>5082</td> <td>\$12.60</td> </tr> <tr> <td>5083</td> <td>5083</td> <td>\$12.60</td> </tr> <tr> <td>5084</td> <td>5084</td> <td>\$7.20</td> </tr> </table>	Part Number	Part	Price Each	5082	5082	\$12.60	5083	5083	\$12.60	5084	5084	\$7.20		<table border="0"> <tr> <td>Medium Double Face Raceway Cover 3" x 48" x .040" (white) Blank</td> <td>Part Number 5085</td> <td>Price Each \$4.69</td> </tr> <tr> <td>Large Double Face Raceway Cover 6-1/2" x 48" x .040" (white) Pre-Punched 7" on Center Pre-Punched 10" on Center Blank</td> <td>5086 5087 5088</td> <td>\$16.20 \$16.20 \$9.36</td> </tr> </table>	Medium Double Face Raceway Cover 3" x 48" x .040" (white) Blank	Part Number 5085	Price Each \$4.69	Large Double Face Raceway Cover 6-1/2" x 48" x .040" (white) Pre-Punched 7" on Center Pre-Punched 10" on Center Blank	5086 5087 5088	\$16.20 \$16.20 \$9.36		
Part Number	Part	Price Each																					
5082	5082	\$12.60																					
5083	5083	\$12.60																					
5084	5084	\$7.20																					
Medium Double Face Raceway Cover 3" x 48" x .040" (white) Blank	Part Number 5085	Price Each \$4.69																					
Large Double Face Raceway Cover 6-1/2" x 48" x .040" (white) Pre-Punched 7" on Center Pre-Punched 10" on Center Blank	5086 5087 5088	\$16.20 \$16.20 \$9.36																					
<h3>Cut To Size Econo Divider</h3>	<table border="0"> <tr> <td data-bbox="397 1575 641 1816"> </td> <td data-bbox="673 1575 868 1648"> <p>1-5/16" Econo Divider</p> </td> <td data-bbox="933 1501 1031 1564"> <p>Part Number 2140</p> </td> <td data-bbox="1112 1501 1258 1564"> <p>Cut to Size Mill Finish \$3.31</p> </td> <td data-bbox="1331 1501 1477 1564"> <p>Cost Per Foot Dk. Bronze \$4.28</p> </td> </tr> </table>		<p>1-5/16" Econo Divider</p>	<p>Part Number 2140</p>	<p>Cut to Size Mill Finish \$3.31</p>	<p>Cost Per Foot Dk. Bronze \$4.28</p>																	
	<p>1-5/16" Econo Divider</p>	<p>Part Number 2140</p>	<p>Cut to Size Mill Finish \$3.31</p>	<p>Cost Per Foot Dk. Bronze \$4.28</p>																			
<h3>Cut To Size Econo Divider Includes</h3>	<ul style="list-style-type: none"> □ Divider Screws, part #5217, for mechanical fastening. □ Divider Corner Angle 1" x 1" x 1/8" (1/2"), part #5325, for use with Econo Molding. □ Extended Divider Corner Angle 1" x 1" x 1/8" (2-1/4"), part #5335, for use with Extended Econo Molding. 																						



EconoComp Extrusions Priced by the Length

	Part	Part Number	Length	Mill Finish	Dk. Bronze
Sign Cabinet Fillers					
  	Large Double Face Filler	2032	24' 6"	\$140.71 <i>Cost per Foot</i> 5.74	\$187.91 7.67
	Medium Double Face Filler	2036	24' 6"	95.17 <i>Cost per Foot</i> 3.88	127.24 5.19
	Single Face Filler	2034	24' 6"	95.72 <i>Cost per Foot</i> 3.91	128.07 5.23
Moldings					
 	Econo Molding	2056	24' 6"	19.64 <i>Cost per Foot</i> 0.80	26.40 1.08
	Extended Econo Molding	2058	24' 6"	60.82 <i>Cost per Foot</i> 2.48	80.05 3.27
Divider					
	1-5/16" Econo Divider	2140	24' 0"	44.34 <i>Cost per Foot</i> 1.85	60.81 2.53

EconoComp System Accessories

	Part	Part Number	Price Each
Components			
	Corner Key .120 Stamped Aluminum	5210	\$0.79 Each
	Divider Angle for Econo Molding 1" x 1" x 1/8" (1/2")	5325	0.97 Each
	Extended Divider Angle for Extended Econo Molding 1" x 1" x 1/8" (2-1/4")	5335	1.30 Each
Hardware			
 	Corner Key Screw Divider Screw #8 x 1/2" coated hex washer self drilling/tapping screw - type A	5217	17.00/100
 	Molding Screw Molding Screw - Dk. Bronze #8 x 1/2" Pan Head Steel Zinc Square/Phillips screw - type A	5290 5290P	8.00/100 18.00/100

EconoComp System Configurations

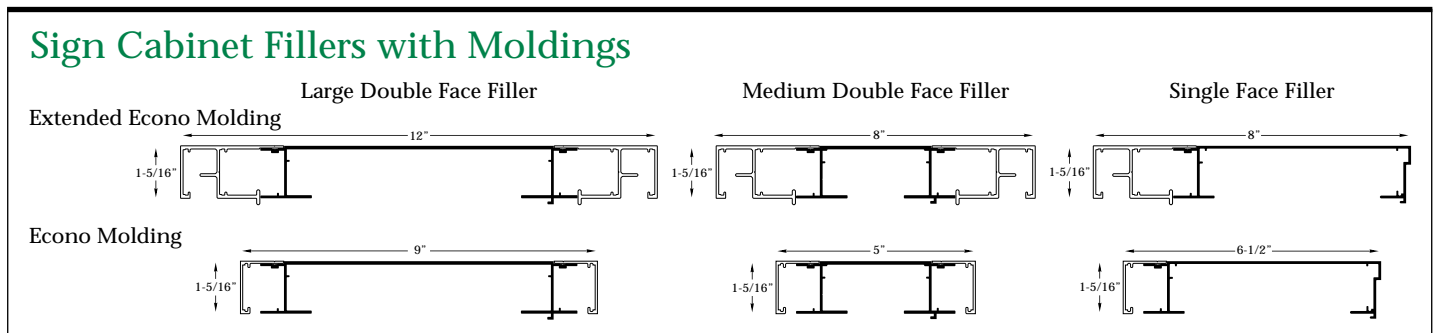



Unassembled 6-1/2" Single Face Kits - For Rigid Faces

Single Face Filler with Econo Molding

Part #2034

Part #2056

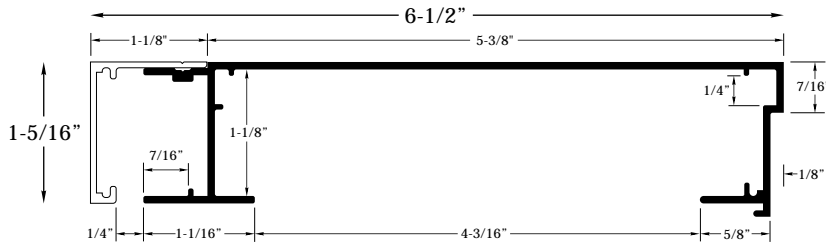

Size H x W	Mill Finish	Dk. Bronze	Size H x W	Mill Finish	Dk. Bronze	Size H x W	Mill Finish	Dk. Bronze	Size H x W	Mill Finish	Dk. Bronze	Size H x W	Mill Finish	Dk. Bronze
1 x 1	\$54	\$62	1.5 x 3.5	\$92	\$113	2 x 13	\$226	\$286	3 x 9	\$187	\$235	4 x 9	\$201	\$253
1 x 2	67	80	1.5 x 4	100	122	2 x 14	240	303	3 x 10	201	253	4 x 10	214	271
1 x 3	80	97	1.5 x 5	113	140	2 x 15	254	321	3 x 11	214	271	4 x 11	226	286
1 x 4	92	113	1.5 x 6	126	156	2.5 x 2.5	92	113	3 x 12	226	286	4 x 12	240	303
1 x 5	107	131	1.5 x 8	153	191	2.5 x 3	100	122	3 x 13	240	303	4 x 13	254	321
1 x 6	120	148	1.5 x 10	181	226	2.5 x 3.5	107	131	3 x 14	254	321	4 x 14	267	338
1 x 7	133	166	2 x 2	80	97	2.5 x 4	113	140	3 x 15	267	338	4 x 15	279	356
1 x 8	147	184	2 x 2.5	87	106	2.5 x 5	126	156	3.5 x 3.5	120	148	5 x 5	160	201
1 x 9	160	201	2 x 3	92	113	2.5 x 6	141	173	3.5 x 4	126	156	5 x 6	173	218
1 x 10	173	218	2 x 3.5	100	122	2.5 x 8	167	209	3.5 x 5	141	173	5 x 7	187	235
1 x 11	187	235	2 x 4	107	131	2.5 x 10	192	244	3.5 x 6	153	191	5 x 8	201	253
1 x 12	201	253	2 x 5	120	148	3 x 3	107	131	3.5 x 8	181	226	5 x 9	214	271
1 x 13	214	271	2 x 6	133	166	3 x 3.5	113	140	3.5 x 10	207	260	5 x 10	226	286
1 x 14	226	286	2 x 7	147	184	3 x 4	120	148	4 x 4	133	166	5 x 11	240	303
1 x 15	240	303	2 x 8	160	201	3 x 5	133	166	4 x 5	147	184	5 x 12	254	321
1.5 x 1.5	67	80	2 x 9	173	218	3 x 6	147	184	4 x 6	160	201	6 x 6	187	235
1.5 x 2	74	88	2 x 10	187	235	3 x 7	160	201	4 x 7	173	218	6 x 7	201	253
1.5 x 2.5	80	97	2 x 11	201	253	3 x 8	173	218	4 x 8	187	235	6 x 8	214	271
1.5 x 3	87	106	2 x 12	214	271									

Included in Sign Cabinet Kit Pricing:

- Mill finish or Pre-painted.
- Four (4) pieces of cut to size and mitered Single Face Filler, Part #2034.
- Four (4) pieces of cut to size and mitered Econo Molding, Part #2056.
- Twelve (12) Corner Keys, Part #5210.
- Twenty-Four (24) Corner Key Screws, Part #5217.
- One (1) Molding Screws, Part #5290 for every perimeter foot of Econo Molding.
- Packaging.

Kit Sizes and Availability:

- It is recommended to order kits 1" over nominal T-12 lamp size to utilize .040 Flat Aluminum Raceway Covers.
- Custom size kits may be cut to any dimension.

Recommended Lamp Spacing:

- For flat plastic, illuminated backgrounds - 7" on center, using T-12 lamps.
- For pan formed faces use guideline for T-12 lamp spacing, see General Information on page 2.
- Always place lamps 3/4" from back of sign.

Not included in Sign Cabinet Kit Pricing:

- Face and Back.
- Raceway Covers.
- Raceway Cover Screws.
- Ballast Brackets.
- Corner Angles - Not required for assembly.
- Electrical Components.
- Structural Supports.

General Information:

- Finishes: See page 2.
- Additional information: See page 2.
- Cut to size and pre-cut kits are available locally through select sign supply distributors.
- Designed for use with Econo Divider: See page 11.



Unassembled 8" Single Face Kits - For Rigid Faces

Single Face Filler with Extended Econo Molding

Part #2034

Part #2058

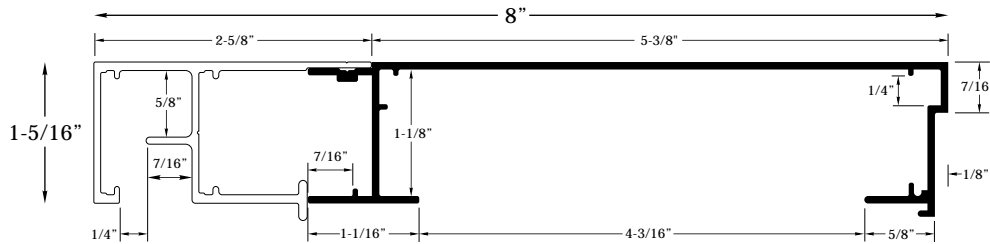

Size H x W	Mill Finish	Dk. Bronze	Size H x W	Mill Finish	Dk. Bronze	Size H x W	Mill Finish	Dk. Bronze	Size H x W	Mill Finish	Dk. Bronze	Size H x W	Mill Finish	Dk. Bronze
1 x 1	\$68	\$80	1.5 x 3.5	\$125	\$153	2 x 13	\$ 314	\$398	3 x 9	\$258	\$326	4 x 9	\$277	\$350
1 x 2	87	104	1.5 x 4	134	166	2 x 14	335	423	3 x 10	277	350	4 x 10	296	374
1 x 3	107	129	1.5 x 5	153	190	2 x 15	354	446	3 x 11	296	374	4 x 11	314	398
1 x 4	125	153	1.5 x 6	173	216	2.5 x 2.5	125	153	3 x 12	314	398	4 x 12	335	423
1 x 5	144	180	1.5 x 8	210	263	2.5 x 3	134	166	3 x 13	335	423	4 x 13	354	446
1 x 6	164	203	1.5 x 10	249	312	2.5 x 3.5	144	180	3 x 14	354	446	4 x 14	372	471
1 x 7	183	227	2 x 2	107	129	2.5 x 4	153	190	3 x 15	372	471	4 x 15	391	496
1 x 8	202	251	2 x 2.5	116	141	2.5 x 5	173	216	3.5 x 3.5	164	203	5 x 5	221	275
1 x 9	221	275	2 x 3	125	153	2.5 x 6	191	239	3.5 x 4	173	216	5 x 6	238	300
1 x 10	238	300	2 x 3.5	134	166	2.5 x 8	230	289	3.5 x 5	191	239	5 x 7	258	326
1 x 11	258	326	2 x 4	144	180	2.5 x 10	268	337	3.5 x 6	210	263	5 x 8	277	350
1 x 12	277	350	2 x 5	164	203	3 x 3	144	180	3.5 x 8	249	312	5 x 9	296	374
1 x 13	296	374	2 x 6	183	227	3 x 3.5	153	190	3.5 x 10	287	362	5 x 10	314	398
1 x 14	314	398	2 x 7	202	251	3 x 4	164	203	4 x 4	183	227	5 x 11	335	423
1 x 15	335	423	2 x 8	221	275	3 x 5	183	227	4 x 5	202	251	5 x 12	354	446
1.5 x 1.5	87	104	2 x 9	238	300	3 x 6	202	251	4 x 6	221	275	6 x 6	258	326
1.5 x 2	98	117	2 x 10	258	326	3 x 7	221	275	4 x 7	238	300	6 x 7	277	350
1.5 x 2.5	107	129	2 x 11	277	350	3 x 8	238	300	4 x 8	258	326	6 x 8	296	374
1.5 x 3	116	141	2 x 12	296	374									

Included in Sign Cabinet Kit Pricing:

- Mill finish or Pre-painted.
- Four (4) pieces of cut to size and mitered Single Face Filler, Part #2034.
- Four (4) pieces of cut to size and mitered Extended Econo Molding, Part #2058.
- Sixteen (16) Corner Keys, Part #5210.
- Twenty-Four (24) Corner Key Screws, Part #5217.
- One (1) Molding Screws, Part #5290 for every perimeter foot of Extended Econo Molding.
- Packaging.

Kit Sizes and Availability:

- It is recommended to order kits 1" over nominal T-12 lamp size to utilize .040 Flat Aluminum Raceway Covers.
- Custom size kits may be cut to any dimension.

Recommended Lamp Spacing:

- For flat plastic, illuminated backgrounds - 10" on center, using T-12 lamps.
- For pan formed faces use guideline for T-12 lamp spacing, see General Information on page 2.
- Always place lamps 3/4" from back of sign.

Not included in Sign Cabinet Kit Pricing:

- Face and Back.
- Raceway Covers.
- Raceway Cover Screws.
- Ballast Brackets.
- Corner Angles - Not required for assembly.
- Electrical Components.
- Structural Supports.

General Information:

- Finishes: See page 2.
- Additional information: See page 2.
- Cut to size and pre-cut kits are available locally through select sign supply distributors.
- Extended Econo Molding Part #2058, is not engineered to directly integrate with the Econo Divider, Part #2140. Minimal additional assembly is required using Extended Divider Angle, Part #5335. See page 11.



Unassembled 5" Double Face Kits - For Rigid Faces

Medium Double Face Filler with Econo Molding

Part #2036

Part #2056

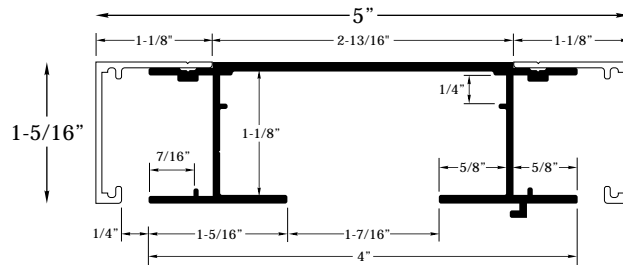

Size H x W	Mill Finish	Dk. Bronze	Size H x W	Mill Finish	Dk. Bronze	Size H x W	Mill Finish	Dk. Bronze	Size H x W	Mill Finish	Dk. Bronze	Size H x W	Mill Finish	Dk. Bronze
1 x 1	\$57	\$67	1.5 x 3.5	\$104	\$127	2 x 13	\$259	\$330	3 x 9	\$211	\$271	4 x 9	\$ 228	\$290
1 x 2	74	88	1.5 x 4	113	138	2 x 14	276	351	3 x 10	228	290	4 x 10	244	310
1 x 3	88	108	1.5 x 5	129	159	2 x 15	291	371	3 x 11	244	310	4 x 11	259	330
1 x 4	104	127	1.5 x 6	143	181	2.5 x 2.5	104	127	3 x 12	259	330	4 x 12	276	351
1 x 5	120	148	1.5 x 8	174	218	2.5 x 3	113	138	3 x 13	276	351	4 x 13	291	371
1 x 6	135	168	1.5 x 10	205	258	2.5 x 3.5	120	148	3 x 14	291	371	4 x 14	308	391
1 x 7	151	189	2 x 2	88	108	2.5 x 4	129	159	3 x 15	308	391	4 x 15	322	411
1 x 8	167	208	2 x 2.5	98	119	2.5 x 5	143	181	3.5 x 3.5	135	168	5 x 5	183	228
1 x 9	183	228	2 x 3	104	127	2.5 x 6	159	201	3.5 x 4	143	181	5 x 6	200	249
1 x 10	200	249	2 x 3.5	113	138	2.5 x 8	189	238	3.5 x 5	159	201	5 x 7	211	271
1 x 11	211	271	2 x 4	120	148	2.5 x 10	222	279	3.5 x 6	174	218	5 x 8	228	290
1 x 12	228	290	2 x 5	135	168	3 x 3	120	148	3.5 x 8	205	258	5 x 9	244	310
1 x 13	244	310	2 x 6	151	189	3 x 3.5	129	159	3.5 x 10	237	299	5 x 10	259	330
1 x 14	259	330	2 x 7	167	208	3 x 4	135	168	4 x 4	151	189	5 x 11	276	351
1 x 15	276	351	2 x 8	183	228	3 x 5	151	189	4 x 5	167	208	5 x 12	291	371
1.5 x 1.5	74	88	2 x 9	200	249	3 x 6	167	208	4 x 6	183	228	6 x 6	211	271
1.5 x 2	81	99	2 x 10	211	271	3 x 7	183	228	4 x 7	200	249	6 x 7	228	290
1.5 x 2.5	88	108	2 x 11	228	290	3 x 8	200	249	4 x 8	211	271	6 x 8	244	310
1.5 x 3	98	119	2 x 12	244	310									

Included in Sign Cabinet Kit Pricing:

- Mill finish or Pre-painted.
- Four (4) pieces of cut to size and mitered Medium Double Face Filler, Part #2036.
- Eight (8) pieces of cut to size and mitered Econo Molding, Part #2056.
- Sixteen (16) Corner Keys, Part #5210.
- Thirty-two (32) Corner Key Screws, Part #5217.
- One (1) Molding Screws, Part #5290 for every perimeter foot of Econo Molding.
- Packaging.

Kit Sizes and Availability:

- It is recommended to order kits 1" over nominal T-12 lamp size to utilize .040 Flat Aluminum Raceway Covers.
- Custom size kits may be cut to any dimension.

Recommended Lamp Spacing:

- For flat or pan formed faces use guideline for T-12 lamp spacing, see General Information on page 2.

Not included in Sign Cabinet Kit Pricing:

- Faces.
- Raceway Covers.
- Raceway Cover Screws.
- Ballast Brackets.
- Corner Angles - Not required for assembly.
- Electrical Components.
- Structural Supports.

General Information:

- Finishes: See page 2.
- Additional information: See page 2.
- Cut to size and pre-cut kits are available locally through select sign supply distributors.
- Designed for use with Econo Divider: See page 11.



Unassembled 8" Double Face Kits - For Rigid Faces

Medium Double Face Filler with Extended Econo Molding

Part #2036

Part #2058

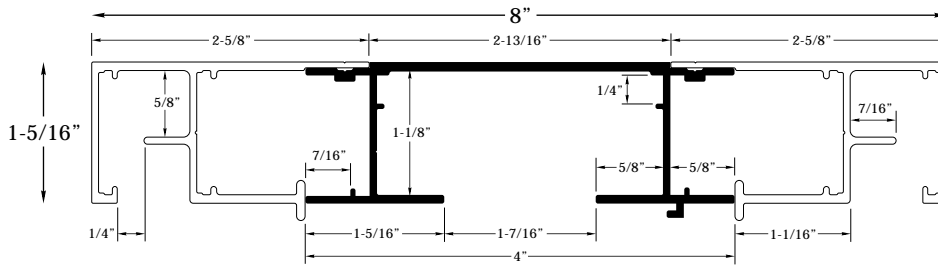

Size H x W	Mill Finish	Dk. Bronze	Size H x W	Mill Finish	Dk. Bronze	Size H x W	Mill Finish	Dk. Bronze	Size H x W	Mill Finish	Dk. Bronze	Size H x W	Mill Finish	Dk. Bronze
1 x 1	\$85	\$100	1.5 x 3.5	\$165	\$204	2 x 13	\$433	\$548	3 x 9	\$353	\$445	4 x 9	\$378	\$480
1 x 2	111	134	1.5 x 4	177	222	2 x 14	460	583	3 x 10	378	480	4 x 10	407	515
1 x 3	137	168	1.5 x 5	205	255	2 x 15	487	618	3 x 11	407	515	4 x 11	433	548
1 x 4	165	204	1.5 x 6	233	291	2.5 x 2.5	165	204	3 x 12	433	548	4 x 12	460	583
1 x 5	191	238	1.5 x 8	286	358	2.5 x 3	177	222	3 x 13	460	583	4 x 13	487	618
1 x 6	219	273	1.5 x 10	338	427	2.5 x 3.5	191	238	3 x 14	487	618	4 x 14	513	651
1 x 7	245	309	2 x 2	137	168	2.5 x 4	205	255	3 x 15	513	651	4 x 15	541	687
1 x 8	272	340	2 x 2.5	151	186	2.5 x 5	233	291	3.5 x 3.5	219	273	5 x 5	299	376
1 x 9	299	376	2 x 3	165	204	2.5 x 6	258	322	3.5 x 4	233	291	5 x 6	326	411
1 x 10	326	411	2 x 3.5	177	222	2.5 x 8	312	393	3.5 x 5	258	322	5 x 7	353	445
1 x 11	353	445	2 x 4	191	238	2.5 x 10	365	463	3.5 x 6	286	358	5 x 8	378	480
1 x 12	378	480	2 x 5	219	273	3 x 3	191	238	3.5 x 8	338	427	5 x 9	407	515
1 x 13	407	515	2 x 6	245	309	3 x 3.5	205	255	3.5 x 10	393	497	5 x 10	433	548
1 x 14	433	548	2 x 7	272	340	3 x 4	219	273	4 x 4	245	309	5 x 11	460	583
1 x 15	460	583	2 x 8	299	376	3 x 5	245	309	4 x 5	272	340	5 x 12	487	618
1.5 x 1.5	111	134	2 x 9	326	411	3 x 6	272	340	4 x 6	299	376	6 x 6	353	445
1.5 x 2	124	152	2 x 10	353	445	3 x 7	299	376	4 x 7	326	411	6 x 7	378	480
1.5 x 2.5	137	168	2 x 11	378	480	3 x 8	326	411	4 x 8	353	445	6 x 8	407	515
1.5 x 3	151	186	2 x 12	407	515									

Included in Sign Cabinet Kit Pricing:

- Mill finish or Pre-painted.
- Four (4) pieces of cut to size and mitered Medium Double Face Filler, Part #2036.
- Eight (8) pieces of cut to size and mitered Extended Econo Molding, Part #2058.
- Twenty-four (24) Corner Keys, Part #5210.
- Thirty-two (32) Corner Key Screws, Part #5217.
- One (1) Molding Screws, Part #5290 for every perimeter foot of Extended Econo Molding.
- Packaging.

Kit Sizes and Availability:

- It is recommended to order kits 1" over nominal T-12 lamp size to utilize .040 Flat Aluminum Raceway Covers.
- Custom size kits may be cut to any dimension.

Recommended Lamp Spacing:

- For flat or pan formed faces use guideline for T-12 lamp spacing, see General Information on page 2.

Not included in Sign Cabinet Kit Pricing:

- Faces.
- Raceway Covers.
- Raceway Cover Screws.
- Ballast Brackets.
- Corner Angles - Not required for assembly.
- Electrical Components.
- Structural Supports.

General Information:

- Finishes: See page 2.
- Additional information: See page 2.
- Cut to size and pre-cut kits are available locally through select sign supply distributors.
- Extended Econo Molding Part #2058, is not engineered to directly integrate with the Econo Divider, Part #2140. Minimal additional assembly is required using Extended Divider Angle, Part #5335. See page 11.



Unassembled 9" Double Face Kits - For Rigid Faces

Large Double Face Filler with Econo Molding

Part #2032

Part #2056

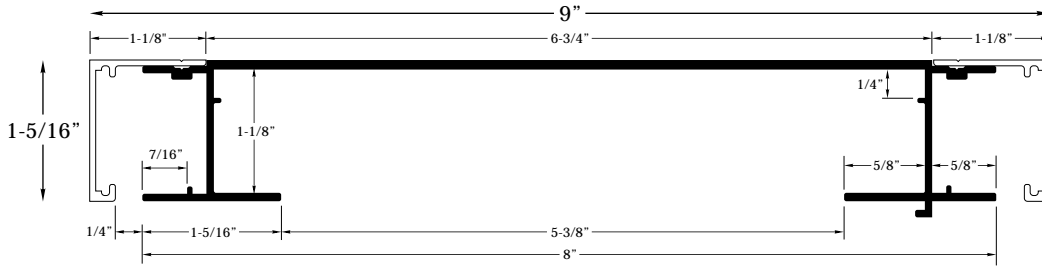

Size H x W	Mill Finish	Dk. Bronze	Size H x W	Mill Finish	Dk. Bronze	Size H x W	Mill Finish	Dk. Bronze	Size H x W	Mill Finish	Dk. Bronze	Size H x W	Mill Finish	Dk. Bronze
1 x 1	\$68	\$81	1.5 x 3.5	\$130	\$163	2 x 13	\$338	\$431	3 x 9	\$276	\$351	4 x 9	\$298	\$376
1 x 2	88	108	1.5 x 4	142	174	2 x 14	358	458	3 x 10	298	376	4 x 10	318	404
1 x 3	109	134	1.5 x 5	163	203	2 x 15	379	484	3 x 11	318	404	4 x 11	338	431
1 x 4	130	163	1.5 x 6	183	228	2.5 x 2.5	130	163	3 x 12	338	431	4 x 12	358	458
1 x 5	151	189	1.5 x 8	224	284	2.5 x 3	142	174	3 x 13	358	458	4 x 13	379	484
1 x 6	170	216	1.5 x 10	266	337	2.5 x 3.5	151	189	3 x 14	379	484	4 x 14	401	511
1 x 7	191	244	2 x 2	109	134	2.5 x 4	163	203	3 x 15	401	511	4 x 15	422	539
1 x 8	215	271	2 x 2.5	120	148	2.5 x 5	183	228	3.5 x 3.5	170	216	5 x 5	234	295
1 x 9	234	295	2 x 3	130	163	2.5 x 6	203	256	3.5 x 4	183	228	5 x 6	256	322
1 x 10	256	322	2 x 3.5	142	174	2.5 x 8	244	310	3.5 x 5	203	256	5 x 7	276	351
1 x 11	276	351	2 x 4	151	189	2.5 x 10	286	363	3.5 x 6	224	284	5 x 8	298	376
1 x 12	298	376	2 x 5	170	216	3 x 3	151	189	3.5 x 8	266	337	5 x 9	318	404
1 x 13	318	404	2 x 6	191	244	3 x 3.5	163	203	3.5 x 10	308	391	5 x 10	338	431
1 x 14	338	431	2 x 7	215	271	3 x 4	170	216	4 x 4	191	244	5 x 11	358	458
1 x 15	358	458	2 x 8	234	295	3 x 5	191	244	4 x 5	215	271	5 x 12	379	484
1.5 x 1.5	88	108	2 x 9	256	322	3 x 6	215	271	4 x 6	234	295	6 x 6	276	351
1.5 x 2	100	122	2 x 10	276	351	3 x 7	234	295	4 x 7	256	322	6 x 7	298	376
1.5 x 2.5	109	134	2 x 11	298	376	3 x 8	256	322	4 x 8	276	351	6 x 8	318	404
1.5 x 3	120	148	2 x 12	318	404									

Included in Sign Cabinet Kit Pricing:

- Mill finish or Pre-painted.
- Four (4) pieces of cut to size and mitered Large Double Face Filler, Part #2032.
- Eight (8) pieces of cut to size and mitered Econo Molding, Part #2056.
- Sixteen (16) Corner Keys, Part #5210.
- Thirty-two (32) Corner Key Screws, Part #5217.
- One (1) Molding Screws, Part #5290 for every perimeter foot of Econo Molding.
- Packaging.

Kit Sizes and Availability:

- It is recommended to order kits 1" over nominal T-12 lamp size to utilize .040 Flat Aluminum Raceway Covers.
- Custom size kits may be cut to any dimension.

Recommended Lamp Spacing:

- For flat plastic, illuminated backgrounds - 7" on center, using T-12 lamps.
- For pan formed faces use guideline for T-12 lamp spacing, see General Information on page 2.

Not included in Sign Cabinet Kit Pricing:

- Faces.
- Raceway Covers.
- Raceway Cover Screws.
- Ballast Brackets.
- Corner Angles - Not required for assembly.
- Electrical Components.
- Structural Supports.

General Information:

- Finishes: See page 2.
- Additional information: See page 2.
- Cut to size and pre-cut kits are available locally through select sign supply distributors.
- Designed for use with Econo Divider: See page 11.



Unassembled 12" Double Face Kits - For Rigid Faces

Large Double Face Filler with Extended Econo Molding

Part #2032

Part #2058

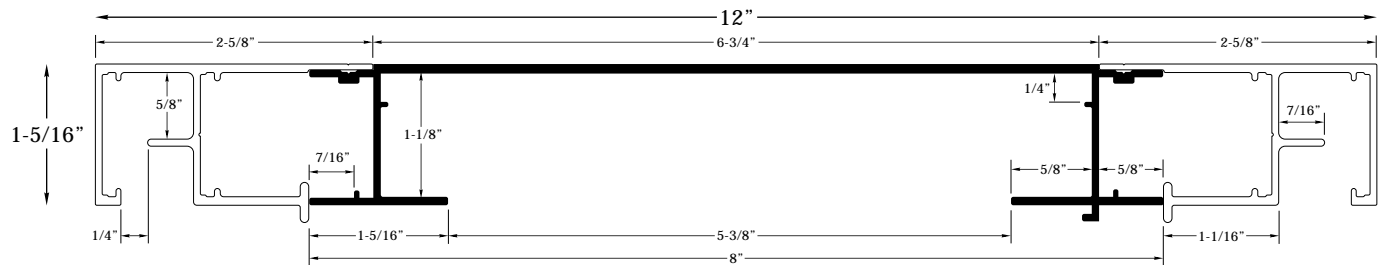

Size H x W	Mill Finish	Dk. Bronze	Size H x W	Mill Finish	Dk. Bronze	Size H x W	Mill Finish	Dk. Bronze	Size H x W	Mill Finish	Dk. Bronze	Size H x W	Mill Finish	Dk. Bronze
1 x 1	\$95	\$113	1.5 x 3.5	\$190	\$237	2 x 13	\$511	\$650	3 x 9	\$414	\$526	4 x 9	\$446	\$567
1 x 2	126	154	1.5 x 4	206	257	2 x 14	543	692	3 x 10	446	567	4 x 10	479	609
1 x 3	159	195	1.5 x 5	238	299	2 x 15	575	732	3 x 11	479	609	4 x 11	511	650
1 x 4	190	237	1.5 x 6	271	339	2.5 x 2.5	190	237	3 x 12	511	650	4 x 12	543	692
1 x 5	223	277	1.5 x 8	335	423	2.5 x 3	206	257	3 x 13	543	692	4 x 13	575	732
1 x 6	255	319	1.5 x 10	398	505	2.5 x 3.5	223	277	3 x 14	575	732	4 x 14	608	775
1 x 7	287	359	2 x 2	159	195	2.5 x 4	238	299	3 x 15	608	775	4 x 15	641	815
1 x 8	319	403	2 x 2.5	173	217	2.5 x 5	271	339	3.5 x 3.5	255	319	5 x 5	352	444
1 x 9	352	444	2 x 3	190	237	2.5 x 6	302	382	3.5 x 4	271	339	5 x 6	384	484
1 x 10	384	484	2 x 3.5	206	257	2.5 x 8	368	464	3.5 x 5	302	382	5 x 7	414	526
1 x 11	414	526	2 x 4	223	277	2.5 x 10	431	546	3.5 x 6	335	423	5 x 8	446	567
1 x 12	446	567	2 x 5	255	319	3 x 3	223	277	3.5 x 8	398	505	5 x 9	479	609
1 x 13	479	609	2 x 6	287	359	3 x 3.5	238	299	3.5 x 10	463	588	5 x 10	511	650
1 x 14	511	650	2 x 7	319	403	3 x 4	255	319	4 x 4	287	359	5 x 11	543	692
1 x 15	543	692	2 x 8	352	444	3 x 5	287	359	4 x 5	319	403	5 x 12	575	732
1.5 x 1.5	126	154	2 x 9	384	484	3 x 6	319	403	4 x 6	352	444	6 x 6	414	526
1.5 x 2	143	174	2 x 10	414	526	3 x 7	352	444	4 x 7	384	484	6 x 7	446	567
1.5 x 2.5	159	195	2 x 11	446	567	3 x 8	384	484	4 x 8	414	526	6 x 8	479	609
1.5 x 3	173	217	2 x 12	479	609									

Included in Sign Cabinet Kit Pricing:

- Mill finish or Pre-painted.
- Four (4) pieces of cut to size and mitered Large Double Face Filler, Part #2032.
- Eight (8) pieces of cut to size and mitered Extended Econo Molding, Part #2058.
- Twenty-four (24) Corner Keys, Part #5210.
- Thirty-two (32) Corner Key Screws, Part #5217.
- One (1) Molding Screws, Part #5290 for every perimeter foot of Extended Econo Molding.
- Packaging.

Kit Sizes and Availability:

- It is recommended to order kits 1" over nominal T-12 lamp size to utilize .040 Flat Aluminum Raceway Covers.
- Custom size kits may be cut to any dimension.

Recommended Lamp Spacing:

- For flat plastic, illuminated backgrounds - 10" on center, using T-12 lamps.
- For pan formed faces use guideline for T-12 lamp spacing, see General Information on page 2.

Not included in Sign Cabinet Kit Pricing:

- Faces.
- Raceway Covers.
- Raceway Cover Screws.
- Ballast Brackets.
- Corner Angles - Not required for assembly.
- Electrical Components.
- Structural Supports.

General Information:

- Finishes: See page 2.
- Additional information: See page 2.
- Cut to size and pre-cut kits are available locally through select sign supply distributors.
- Extended Econo Molding Part #2058, is not engineered to directly integrate with the Econo Divider, Part #2140. Minimal additional assembly is required using Extended Divider Angle, Part #5335. See page 11.



EconoComp System Instructions

Corner Assembly

Large Double Face Filler (front and back)
 Medium Double Face Filler (front and back)
 Single Face Filler (front)

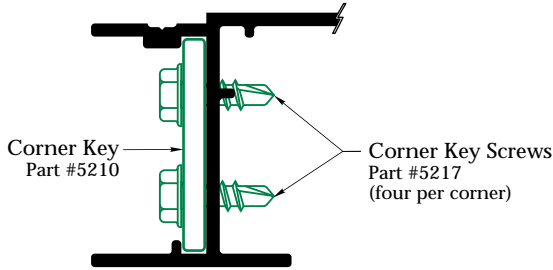

1. Insert Corner Keys, part #5210 into extruded slots, two (2) per corner.
2. Fasten Corner Key, part #5210 to Filler with Corner Key Screws, part #5217, four (4) per corner.
3. Use opaque silicone to caulk inside of mitered corners.

Single Face Filler (back)

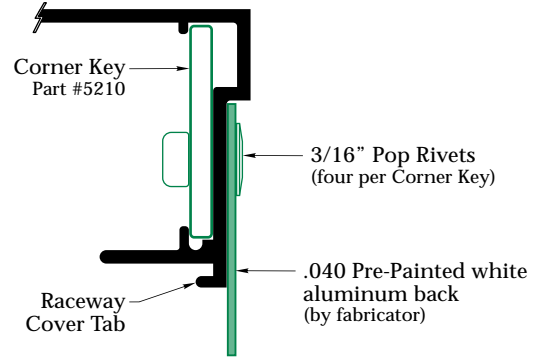

Note: Be sure to align Raceway Cover Tabs prior to cutting and/or assembly.

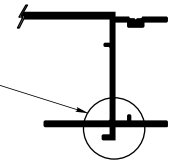

Molding Assembly

1. Drill 1/8" pilot holes along extruded scribe line located on molding surface. Placement of the pilot holes should be approximately 2" from each corner and 18" on center.
2. Insert Molding Screw, part #5290. DO NOT over tighten. Hint: Use beeswax to lubricate Molding Screw insertion.

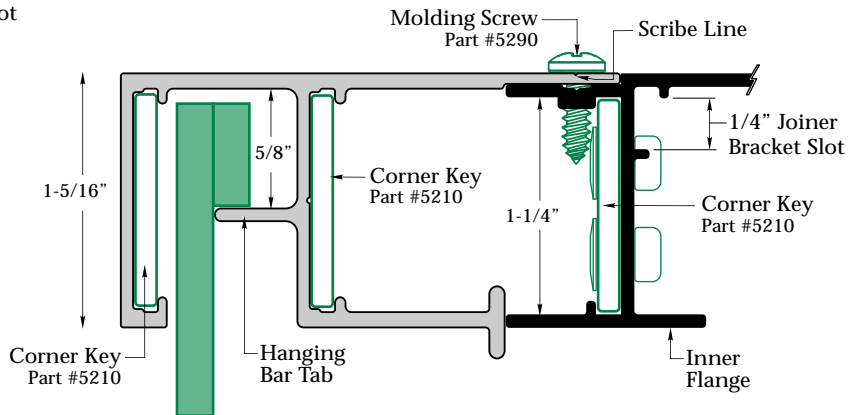
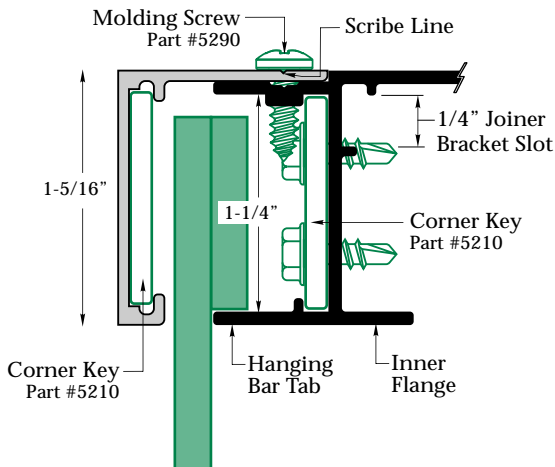

Raceway Cover Assembly

Large Double Face Filler
 Part #2032



Raceway Cover Blank
 6-1/2" x 48" x .040" (white)
 Part #5088

Medium Double Face Filler
 Part #2036



Raceway Cover Blank
 3" x 48" x .040" (white)
 Part #5085

Single Face Filler
 Part #2034

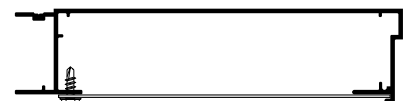

Raceway Cover Blank
 5-1/8" x 48" x .040" (white)
 Part #5084



EconoComp System Instructions

1-5/16" Econo Divider

Fig. A

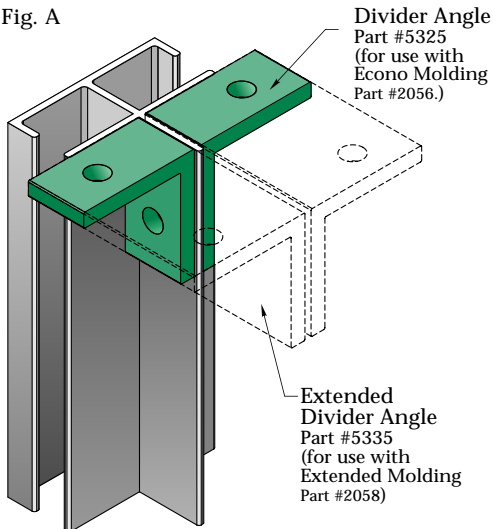

1. Position and clamp two (2) Divider Angles flush with the end of the Econo Divider, Part #2140. Note: When using the Econo Molding, Part #2056 use the Divider Angle, Part #5325. When using the Extended Econo Molding, Part #2058, use the Extended Divider Angle, Part #5335. See Fig. A.
2. Drill an 1/8" pilot hole through the Divider Angles and Econo Divider, Part #2140.
3. Insert the #8 x 1/2" Divider Screws, Part #5217 into the pre-drilled 1/8" hole
4. Repeat steps 1-3 on opposite end of the Econo Divider, Part #2140.
5. Position and clamp the Econo Divider, Part #2140 to the Inner Flange of the Filler so the face of the Econo Divider, Part #2140 is flush with the face of the Econo Molding, Part #2056 or the Extended Molding, Part #2058 at each end. See Fig. B.
Note: When using the Extended Molding, Part #2058 the back leg will need to be notched to allow the Econo Divider, Part #2140 and Extended Divider Angles, Part #5335 to be flush with the Extended Molding. See Fig. B.
6. Drill 1/8" pilot hole through the Divider Angle and Inner Flange.
7. Insert the #8 x 1/2" Divider Screw, Part #5217 into the pre-drilled 1/8" hole.

Fig. B

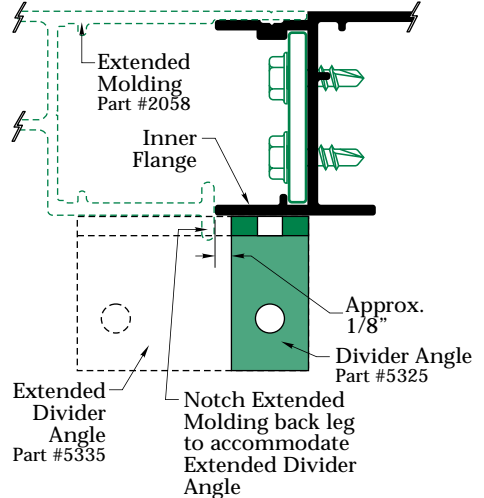

Note: 1-5/16" Econo Divider is engineered for use with the Econo Molding. To use the 1-5/16" Econo Divider with the Extended Econo Molding, attach the Econo Divider to the Inner Flange using the Extended Divider Angle, part #5335 as noted and shown above.

Additional Information

Freight Policy

- The freight shall be prepaid, F.O.B. Grand Rapids, Michigan for single orders of extrusions and/or accessories whereby the invoiced amount is \$5,000.00 or more to any single destination within the continental United States or Canada.
- The freight shall be collect, F.O.B. Grand Rapids, Michigan for all orders other than as stated in this freight policy.
- All freight claims for freight collect shipments are the sole responsibility of the buyer.
- Any requests for expedited freight services shall be the sole expense of the buyer.
- Combining stock items with custom run items qualifies for freight prepaid status only when all items ship as one shipment.

Minimum Order

- Any single full length extrusion profile and/or prepackaged accessories.
- Any single kit.

Availability

- Typical extrusion and accessory orders ship within three (3) days upon receipt and acceptance of your purchase order.
- All orders will receive an approximate ship date upon receipt and acceptance of the written purchase order and confirmation.

Return Policy

- Returns of SignComp products will not be accepted without prior authorization and written RMA number from SignComp.
- Materials may not be returned for any reason other than defective product or incorrect fulfillment of order.
- All goods to be returned must be acknowledged in writing within the 60 day grace period from the date of the shipment. Any claims after this period will be considered invalid.
- All returned goods must be in new and saleable condition for full credit to be issued.

Additional Product Offerings

- Custom extrusions. Mill shipment programs.
- Pre-painted and cut to length extrusion programs.

Backorder Policy

- In the very unlikely event of a back order, the back order will be shipped freight prepaid only if the original order qualified for freight prepaid status.
- Additional materials may be added to any back order, shipped freight prepaid with the additional freight expense the responsibility of the buyer.
- Any expedited freight service requested by the buyer shall be at the expense of the buyer.

Exclusive Warranty and Remedies

- In effect as of January 1, 2008.
- This is the exclusive warranty policy of SignComp, LLC, Grand Rapids, Michigan 49544 (the "Company") with respect to any and all of its products.

EXCLUSIVE WARRANTY

- The Company warrants you as the original purchaser that the Company's products will be free from defects in materials and workmanship, under normal conditions, upon shipment of said products from the Company, for 30 days.
- This exclusive warranty does not apply to damage caused by improper handling. The company shall have no liability or responsibility for any damage whatsoever caused by handling.
- The Company hereby disclaims any and all other warranties, including, without limitation, implied warranties of merchantability and fitness for a particular purpose. The only warranty with respect to the Company's products is described in this exclusive warranty. No oral or written representations shall extend the Company's exclusive warranty beyond the description herein.

WARRANTY PROCEDURES

- The purchaser must notify the Company of any warranty claim prior to initiating any remedy upon the defective product. Upon receipt of such notice, the Company will direct that an authorized representative inspect the product and, if necessary, correct the defect in accordance with this exclusive warranty. The Company shall have the exclusive right to determine whether or not a defect is covered by this exclusive warranty.

REMEDIES

- Provided that the warranty procedures are followed, the Company will repair and/or replace the defective SignComp product(s) during the applicable warranty period without charge for parts or labor.
- Repair and/or replacement of defective SignComp products is your exclusive remedy under the Company's exclusive warranty.
- The Company shall not be liable for any incidental or consequential damages if the Company's product is defective or does not conform to this exclusive warranty. In any event the maximum amount for which the Company shall be liable to the purchaser shall be the original purchase price of the defective SignComp product(s).
- Any claim for breach of this exclusive warranty shall be brought, if at all, no later than 30 days from the Company's breach.

ADDRESS FOR NOTIFICATION

- Notice of a product defect covered by this exclusive warranty can be made in writing or by telephone. The Company's address and telephone numbers are:

SignComp, LLC, 3032 Walker Ridge Dr. NW, Grand Rapids, MI 49544
 Attention: Customer Service - Phone: (616) 784-0405
 Toll Free: (877) 784-0405
 Fax: (616) 784-0411
 e-mail: signcomp@signcomp.com

Environmentally Friendly



Products • Processes • Facility

Our Mission: To promote business and personal practices that will decrease our impact on the environment and minimize our carbon footprint by reducing the demands placed upon our planet in an earth-friendly way.



3032 Walker Ridge Dr. NW
Grand Rapids, MI 49544
U.S.A.
toll free: (877) 784-0405 (US and Canada)
local: (616) 784-0405
fax: (616) 784-0411
e-mail: signcomp@signcomp.com
canada@signcomp.com
www.signcomp.com
© SignComp LLC