









Flat Wall Mount Retro Body with Retainer / Frame Options

Part	Part Number	Length	Finish
 Flat Wall Mount Retro Body	2042	24'-6"	Mill Finish
 Flat 1-1/2" Retainer	2052	24'-6"	Mill Finish
 Flat 2" Retainer	2047	24'-6"	Mill Finish
 Flat Bleed Rigid Retainer	2204	24'-6"	Mill Finish
 Flat Bleed Retro Frame (3 Cover options available)	2104	24'-6"	Mill Finish
 Flat Bleed Retro Frame II (3 Cover options available)	2107	24'-6"	Mill Finish

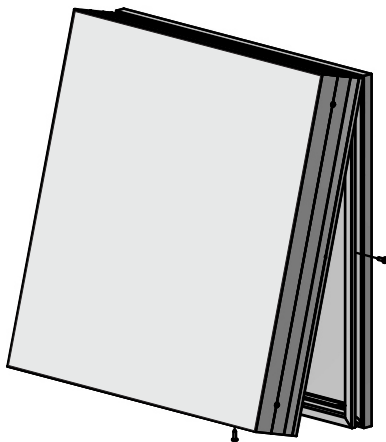

Flat Wall Mount Retro Body
Part # 2042
Flat 2" Retainer
Part # 2047

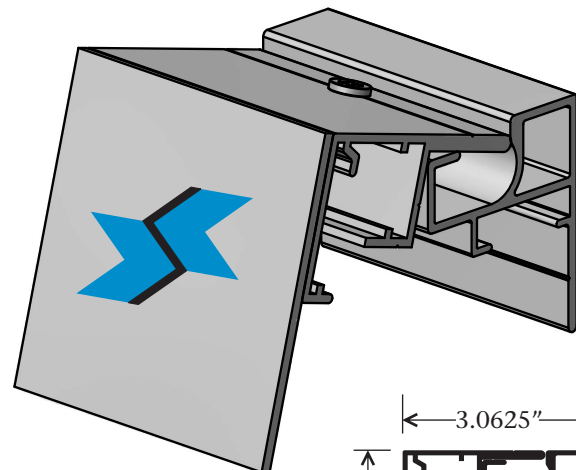

Flat Wall Mount Retro Body
Part # 2042
Flat Bleed Retro Frame II
Part # 2107
Flat Bleed Retro Frame Cover
Part # 2121

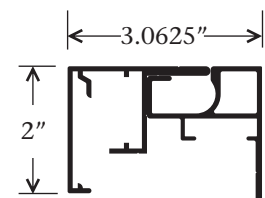
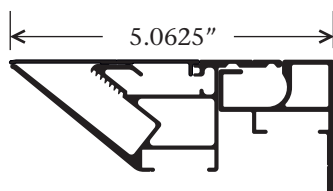

US Patent No. 9,208,701

08/29/17