

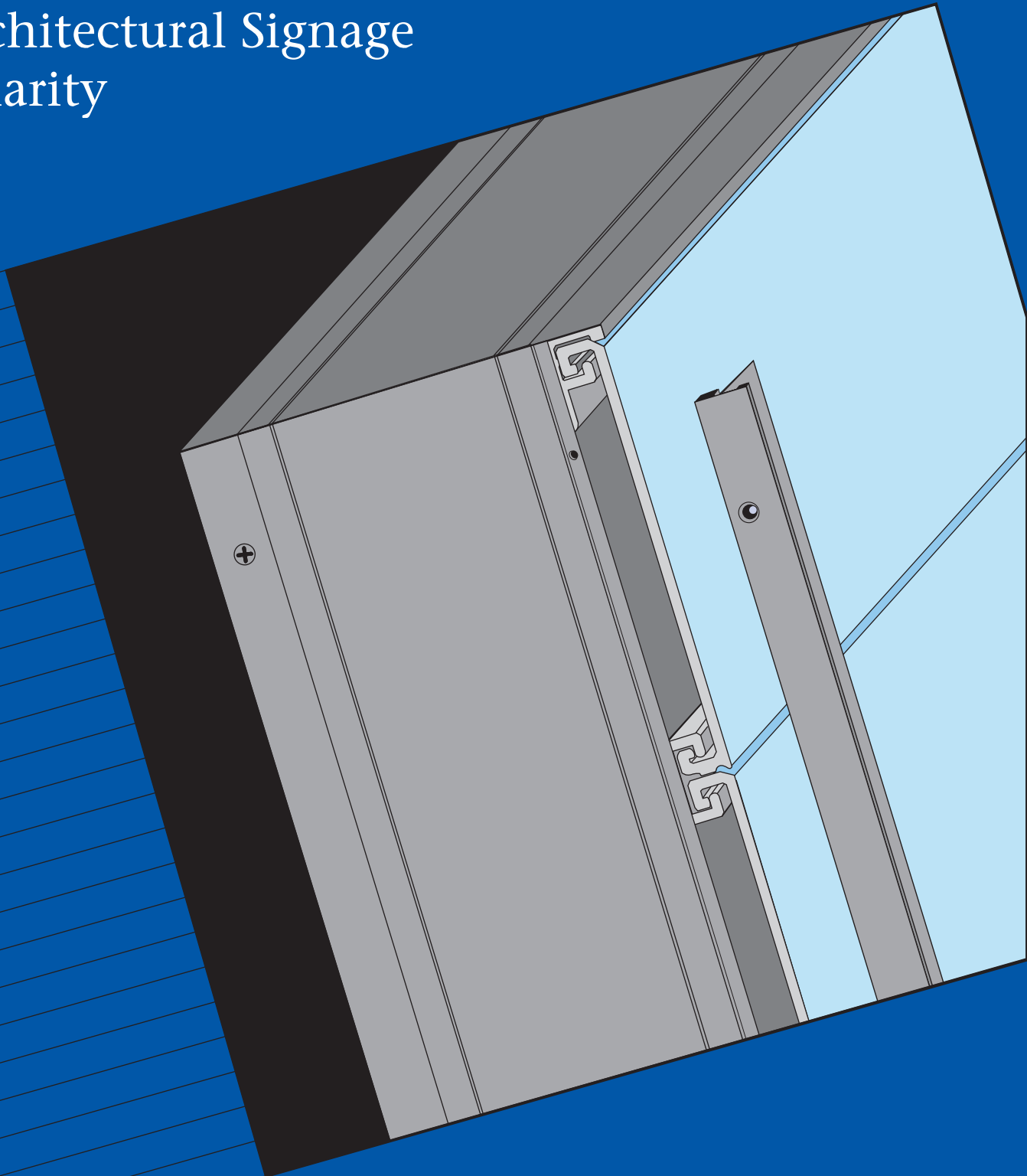

# INSERT PANEL SYSTEM for Architectural Signage Modularity



# The Simplicity of Flush Changeable Panels

## System Design Intent

**SignComp's Insert Panels are:**

- Quickly removable
- Completely interchangeable
- Easily replaceable

*They simply slide in and out after the Insert Panel End Cover is removed.*

- Illuminated applications
- Non-illuminated applications
- Hingeable and Non-hingeable aluminum framework
- Flush frameless appearance
- Concealed structural divider system

### Choice of custom size panels

Custom height panels may be placed anywhere on the face

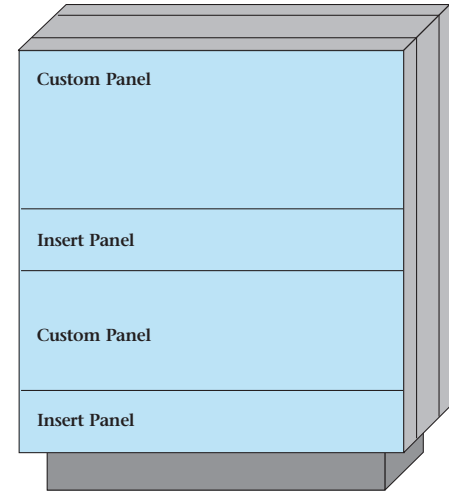

## Insert Panel Options

**Choice of three extruded Aluminum Insert Panels 4", 6" and 8" or create custom height Aluminum Insert Panels by fixing Aluminum Insert Adaptors to .090" aluminum sheet**

- Extruded aluminum
- 16'2" extruded panel lengths
- 8'1" extruded panel adaptor lengths
- Clear anodized to facilitate the sliding motion
- For illuminated applications:  
Routed out graphics backed with plastic
- For non-illuminated applications:  
Painted or applied vinyl graphics

**Create custom height Plastic Insert Panels by fixing Plastic Insert Adaptors to .125" plastic sheet**

- Extruded modified DR black acrylic
- 8'1" extruded panel adaptor lengths
- For illuminated applications:  
Surface painted opaque background over applied masking films (applied masking films are removed to reveal translucent graphics)
- Plastic panel perimeter edges must be painted opaque
- For non-illuminated applications:  
Painted or applied vinyl graphics

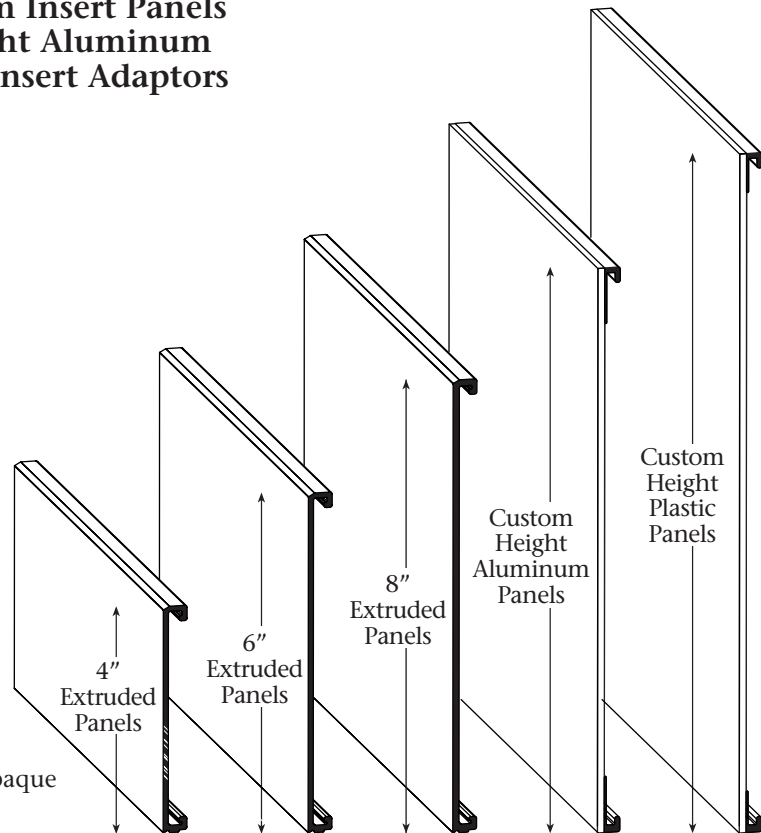



## Insert Retainer Options

<p><b>Commercial Access Frame</b> Part #2060</p>	<p><b>Insert Retainer</b> Part #1666</p>	<p><b>Insert Top/Bottom Cover</b> Part #1292</p>
--	--	--

## SignComp Design Options

<p><b>8-1/2" Radius 3 Part End</b> Part #1673 For double face, hingeable applications</p> <p>8-1/2" Radius 3 Part End Part #1673</p>	<p>17"</p> <p>Adjustable Reveal</p> <p>Top Plan View</p> <p>Wide Body with Access Frame and Insert End Cover</p>	<p>Elevation View</p>
<p><b>6" Radius 1/4 Round End</b> Part #1671 For double sided, hingeable applications</p> <p>6" Radius 1/4 Round End Part #1671</p>	<p>12"</p> <p>Adjustable Reveal</p> <p>Top Plan View</p> <p>Series 12 Hinge Body with Access Frame and Insert End Cover</p>	<p>Elevation View</p>
<p><b>Series 7 Posts</b> For post &amp; panel, hingeable applications</p> <p>3 Post Options</p>	<p>7"</p> <p>7"</p> <p>Adjustable Reveal</p> <p>Top Plan View</p> <p>Top Plan View</p> <p>Series 7 Hinge Body with Access Frame and Insert End Cover</p>	<p>Elevation View</p>



## SignComp Design Options

**6" Radius 1/4 Round End**  
Part #1671  
For wall mounted, hingeable applications

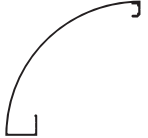

6" Radius  
1/4 Round End  
Part #1671

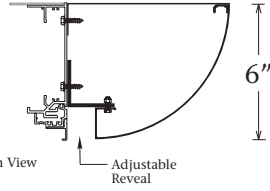

Top Plan View      Adjustable Reveal

6"

Series 7 Single Face Hinge Body with Access Frame and Insert End Cover

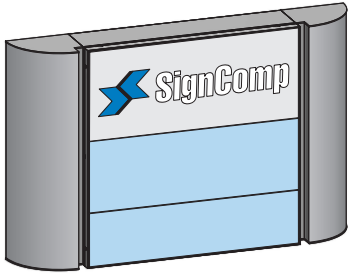

Elevation View

---

**Series 3 Posts**  
For double and single face post & panel applications

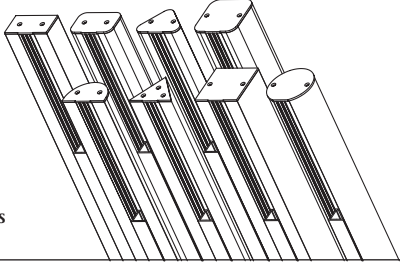

8 Post Options

**Double Face Access Body**  
Part #1290

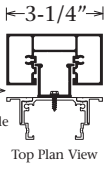

Adjustable Reveal      Top Plan View

←3-1/4"→

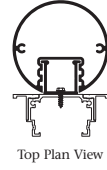

←3-1/4"→

Top Plan View

**Single Face Access Body**  
Part #1291

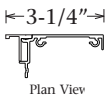

←3-1/4"→

Plan View



←3-1/4"→

Top Plan View

Wall Mount Application

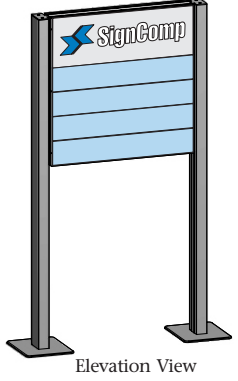

Elevation View

---

**Series 7/12 Retro Body**  
Part #1600  
For retro fit or custom depth applications

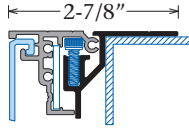

←2-7/8"→

Custom depth, hingeable, single or double face applications are achieved by attaching the Series 7/12 Retro Body to fabricated or existing sign cabinet frames.

## SignComp Mounting Options

**Internal Mounting System-  
Inboard Posts**

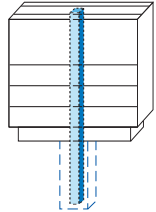

Direct Burial

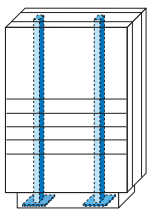

Base Plate Mounting

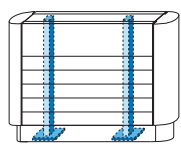

Base Plate Mounting

Fabricated base skirts are easily removed for access to mounting plates

**External Mounting System-  
Outboard Posts**

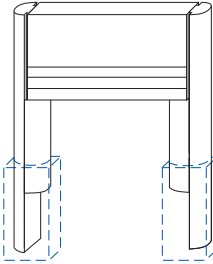

Direct Burial

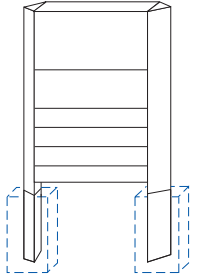

Direct Burial

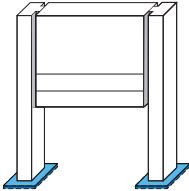

Base Plate Mounting

Wall projection, ceiling mount and sleeve mounting applications are available options

*Note: All foundations, mounting supports and mounting plates to be provided by fabricator.*



# The simplicity of SignComp's changeable Insert Panels on hingeable aluminum frames

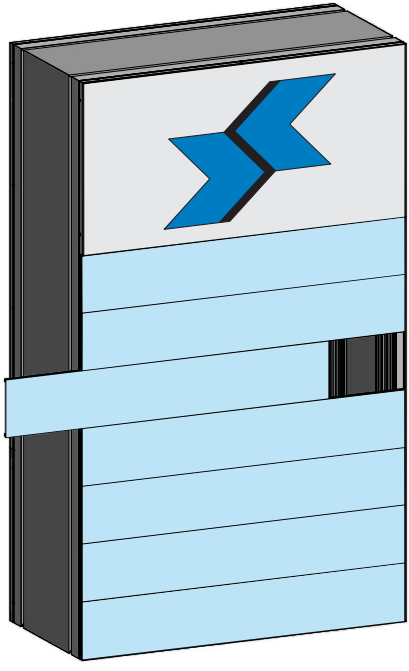

Insert Panels slide in and out after Insert End Cover is removed

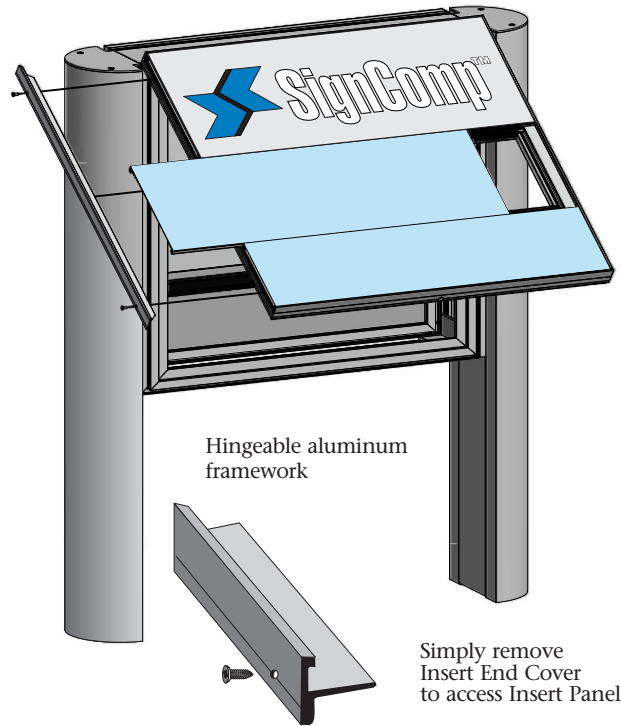

Hingeable aluminum framework

Simply remove Insert End Cover to access Insert Panels

## End Cover Options

### Insert End Cover Part #1696

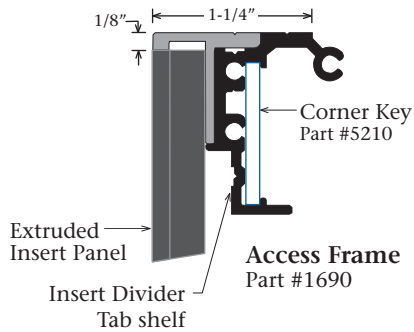

- Flush, countersunk stainless steel fasteners hold the Insert End Cover in place.
- Concealed, structural dividers support the Insert Panels.
- Aluminum Insert Panels, Insert Divider, Insert Retainer, and Aluminum Insert Panel Adaptors are supplied in black or clear anodized to facilitate the sliding motion.
- Integrated, hingeable frame allows for easy access for service.

### Extended Insert End Cover Part #1698

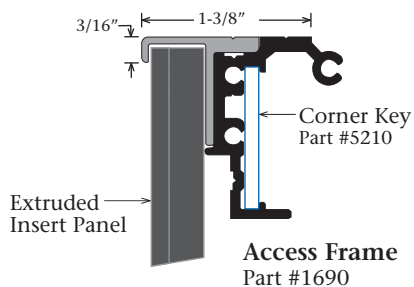



Insert Panels are supported the full width by concealed Insert Dividers

End view of Insert Divider

**NOTE:** Extended Insert End Cover is used with plastic adaptors and all illuminated applications

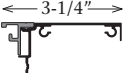

## Available in Architectural Series 3, 7 and 12

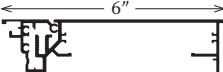
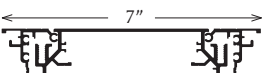
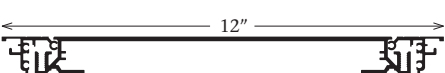
	<b>Series 7/12 Retro Body</b> Part #1600	Double face or single face, hingeable applications
	<b>Series 3 Single Face Access Body</b> Part #1291	Single Face, non-hingeable applications
	<b>Series 3 Access Body</b> Part #1290	Double Face, non-hingeable applications
	<b>Series 7 Single Face Hinge Body</b> Part #1602	Single face, hingeable applications
	<b>Series 7 Hinge Body</b> Part #1592	Double face, hingeable applications
	<b>Series 12 Hinge Body</b> Part #1612	Double face, hingeable applications

## Available with all Commercial Bodies

w/ Commercial Access Frame, Part #2060 and Insert Top/Bottom Cover, Part #1292

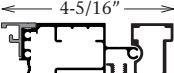
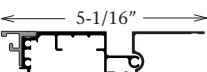
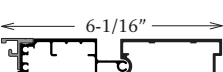
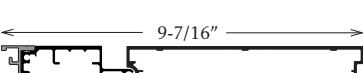
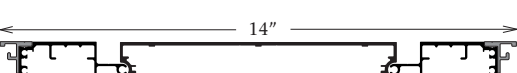
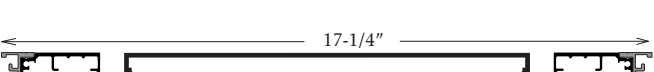
	<b>Slimline S/F Body</b> Part #2020	Single face, hingeable applications
	<b>Retro Body</b> Part #2040	Double face or single face, hingeable applications
	<b>Narrow S/F Body</b> Part #2021	Single face, hingeable applications
	<b>Single Face Body</b> Part #2025	Single face, hingeable applications
	<b>Medium Body</b> Part #2015	Double face, hingeable applications
	<b>Wide Body</b> Part #2005	Double face, hingeable applications

NOTE: When using the Commercial Insert System, rigid and flexible face retainers can be used in the same sign frame.